

**SELKIRK®**

Model R  
Type B Gas Vent  
Large Diameter



Diameters 10" - 30" round  
Type B Gas Vent for  
Residential and Commercial  
applications

**FEATURES**

- Lightweight
- Smaller footprint
- Easy to connect





## MODEL R LARGE DIAMETER TYPE B GAS VENT

INTRODUCTION .....	2
PIPE SECTIONS .....	3
ADJUSTABLE LENGTH .....	3
45° ELBOW .....	4
TEE .....	4
TEE CAP .....	4
CAP .....	5
DRAFT HOOD CONNECTOR .....	6
INCREASER .....	6
SUPPORT BRACKET ASSEMBLY .....	6
VENT COLLAR .....	7
WALL THIMBLE .....	7
SUPPORT PLATE .....	7
STANDARD FLASHING .....	8
TALL CONE FLASHING .....	8
ADJUSTABLE STORM COLLAR .....	8
GAS VENT TERMINATION TABLE .....	9
GAS VENT OFFSETS TABLE .....	9
SYSTEM DESIGN AND INSTALLATION GUIDES .....	10
TYPICAL INSTALLATIONS .....	11
WARRANTY .....	12

Selkirk Model R Large Diameter Type B Gas Vent was designed with the installer in mind and to endure the elements. Lightweight construction with a small footprint, Selkirk Model R will deliver when space is tight but performance is essential. Easy to connect and assemble, you can count on a secure fit when installing Selkirk Model R.

Selkirk's Model R Type B Gas Vent is listed and approved by UL for residential, commercial, and industrial applications. Selkirk Model R provides a continuous passageway from a Category 1 gas appliance, such as water heaters, boilers, and furnaces, to the termination of the vent above the roof of a structure.

Some of the safety features within Model R includes:

- Double wall construction with ½" air space
- Clearance to combustibles standards of:
  - 1" in the United States for all diameters
  - 1" in Canada for diameters 10" to 24"
  - 2" in Canada for diameters 26" to 30"
- Galvanized steel outer wall construction for exceptional corrosion resistance \*exterior applications must be painted in Canada\*
- Aluminum inner wall construction to keep flue gases hot





Model R is to be installed in single and multi-story buildings in accordance with the following Natural Gas & Propane Codes:  
 USA: NFPA 54  
 CANADA: CAN/CSA B149.1 & .2

Selkirk Model R is accepted by: AGA, NFPA, HUD, NBC, UBC



## *Why Selkirk Model R?*

### **Lightweight**

We keep the connections clean to reduce the weight of the pipe making installation a SNAP (twist-snap that is).

### **Smaller footprint**

Clean connections coupled with a ½" air space tighten the diameter of the pipe to create a solid connection suitable for tight spaces.

### **Easy to connect**

Model R's snap lock coupling system creates a secure, confident connection. Simply align the seams, twist, and SNAP – ready to go!

### **Backed by an exceptional warranty**

We are so confident in Selkirk Model R's ability to satisfy, we've backed it by the industry's finest warranty, the Smart Choice Warranty.

### Round Pipe



- To calculate installed height, deduct 1" for each joint.

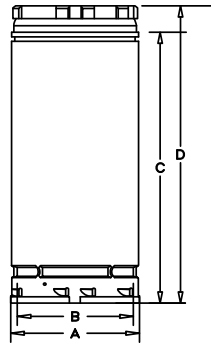

Size	Code	Part #	O.D. (A)	I.D. (B)	C	D
10"	2006317	10R3-S	11"	10"	35"	36"
	2003616	10R24-S	11"	10"	23"	24"
	2003615	10R18-S	11"	10"	17"	18"
	2003614	10R12-S	11"	10"	11"	12"
12"	2003636	12R3-S	13"	12"	35"	36"
	2003635	12R24-S	13"	12"	23"	24"
	2003634	12R18-S	13"	12"	17"	18"
	2003633	12R12-S	13"	12"	11"	12"
14"	2003674	14R3-S	15"	14"	35"	36"
	2003673	14R24-S	15"	14"	23"	24"
	2003672	14R18-S	15"	14"	17"	18"
	2003671	14R12-S	15"	14"	11"	12"
16"	2003692	16R3-S	17"	16"	35"	36"
	2003691	16R24-S	17"	16"	23"	24"
	2003690	16R18-S	17"	16"	17"	18"
	2003689	16R12-S	17"	16"	11"	12"

Size	Code	Part #	O.D. (A)	I.D. (B)	C	D
18"	2003710	18R3-S	19"	18"	35"	36"
	2003709	18R24-S	19"	18"	23"	24"
	2003708	18R18-S	19"	18"	17"	18"
	2003707	18R12-S	19"	18"	11"	12"
20"	2003728	20R3-S	21"	20"	35"	36"
	2003727	20R24-S	21"	20"	23"	24"
	2003726	20R18-S	21"	20"	17"	18"
	2003725	20R12-S	21"	20"	11"	12"
22"	2003746	22R3-S	23"	22"	35"	36"
	2003745	22R24-S	23"	22"	23"	24"
	2003744	22R18-S	23"	22"	17"	18"
	2003743	22R12-S	23"	22"	11"	12"
24"	2003764	24R3-S	25"	24"	35"	36"
	2003763	24R24-S	25"	24"	23"	24"
	2003762	24R18-S	25"	24"	17"	18"
	2003761	24R12-S	25"	24"	11"	12"
26"	2003781	26R3-S	27"	26"	35"	36"
	2003780	26R24-S	27"	26"	23"	24"
	2003779	26R18-S	27"	26"	17"	18"
	2003778	26R12-S	27"	26"	11"	12"
28"	2003797	28R3-S	29"	28"	35"	36"
	2003796	28R24-S	29"	28"	23"	24"
	2003795	28R18-S	29"	28"	17"	18"
	2003794	28R12-S	29"	28"	11"	12"
30"	2003812	30R3-S	31"	30"	35"	36"
	2003811	30R24-S	31"	30"	23"	24"
	2003810	30R18-S	31"	30"	17"	18"
	2003809	30R12-S	31"	30"	11"	12"

### Adjustable Length



- Adjustable length telescopes into standard pipe sections to reach desired length.

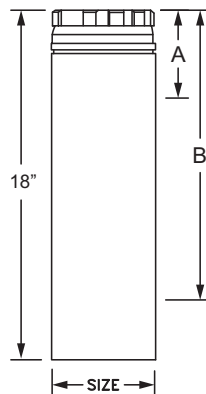

Code	Part #	Size	Min. Length A	Max. Length B
2003618	10R18A-S	10"	3"	16"
2003637	12R18A-S	12"	3"	16"
2003675	14R18A-S	14"	5"	16"
2003693	16R18A-S	16"	5"	16"
2003711	18R18A-S	18"	5"	16"
2003729	20R18A-S	20"	5"	16"
2003747	22R18A-S	22"	5"	16"
2003765	24R18A-S	24"	5"	16"
2003782	26R18A-S	26"	5"	16"
2003798	28R18A-S	28"	5"	16"
2003951	30R18A-S	30"	5"	16"

## 45° Elbow



- Elbows are used to offset installation to avoid obstructions such as rafters and joists.
- Size 10" through 14" adjust easily from 0° to 45°.
- Sizes 16" through 30" are non-adjustable.
- See the Gas Vent Offset Table on page 9.

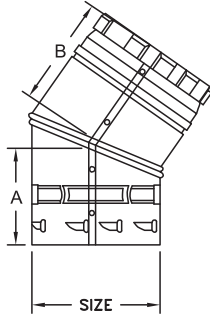

Code	Part #	Size	A	B	Adjustable
2003623	10R45-S	10"	5 <sup>7</sup> / <sub>8</sub> "	5 <sup>3</sup> / <sub>8</sub> "	0° - 45°
2003641	12R45-S	12"	6"	5 <sup>3</sup> / <sub>8</sub> "	0° - 45°
2003680	14R45-S	14"	6 <sup>5</sup> / <sub>8</sub> "	6 <sup>1</sup> / <sub>2</sub> "	0° - 45°
2003698	16R45-S	16"	7"	7"	NON
2003716	18R45-S	18"	7 <sup>1</sup> / <sub>2</sub> "	7 <sup>1</sup> / <sub>2</sub> "	NON
2003734	20R45-S	20"	8"	7 <sup>5</sup> / <sub>8</sub> "	NON
2003752	22R45-S	22"	8 <sup>1</sup> / <sub>2</sub> "	8 <sup>5</sup> / <sub>8</sub> "	NON
2003769	24R45-S	24"	8 <sup>5</sup> / <sub>8</sub> "	8 <sup>15</sup> / <sub>16</sub> "	NON
2003785	26R45-S	26"	9"	9"	NON
2003800	28R45-S	28"	9 <sup>1</sup> / <sub>2</sub> "	9"	NON
2004004	30R45-S	30"	10"	10"	NON

## Tee



- A tee transitions a system from horizontal to vertical orientation.
- Branch and trunk diameters of the standard tee are the same size.

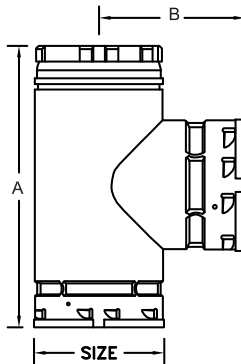

Code	Part #	Size	A	B
2003629	10RT-S	10"	16"	8 <sup>1</sup> / <sub>16</sub> "
2003647	12RT-S	12"	17 <sup>9</sup> / <sub>16</sub> "	9 <sup>3</sup> / <sub>4</sub> "
2003686	14RT-S	14"	24"	11 <sup>3</sup> / <sub>4</sub> "
2003704	16RT-S	16"	26"	13"
2003722	18RT-S	18"	28 <sup>1</sup> / <sub>2</sub> "	14 <sup>1</sup> / <sub>4</sub> "
2003740	20RT-S	20"	30"	15 <sup>1</sup> / <sub>2</sub> "
2003758	22RT-S	22"	33"	16 <sup>3</sup> / <sub>4</sub> "
2003775	24RT-S	24"	36"	18"
2003791	26RT-S	26"	38"	19"
2003806	28RT-S	28"	40"	20"
2003818	30RT-S	30"	42"	21"

## Tee Cap



- The Tee Cap is used to close the bottom or branch of the Tee.

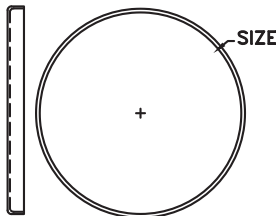

Code	Part #	Size
2003630	10RTC-S	10"
2003648	12RTC-S	12"
2003687	14RTC-S	14"
2003705	16RTC-S	16"
2003723	18RTC-S	18"
2003741	20RTC-S	20"
2003759	22RTC-S	22"
2003776	24RTC-S	24"
2003792	26RTC-S	26"
2003807	28RTC-S	28"
2003819	30RTC-S	30"

## Cap



**Model C  
Universal Cap**

- **Used as a ventilation cap as well as a Type B gas vent termination.**
- **Protects against wind conditions that can cause gases to spill back into the structure.**
- **Reference the Gas Vent Termination Table on page 9, for minimum height requirement above the roof line.**

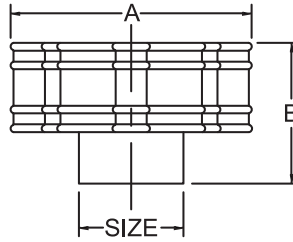

Code	Part #	Size	A	B
2003822	10C-S	10"	15 <sup>3</sup> / <sub>4</sub> "	7 <sup>1</sup> / <sub>2</sub> "
2003823	12C-S	12"	19"	9"
2003682	14C-S	14"	22"	11"
2003700	16C-S	16"	25"	12"
2003718	18C-S	18"	28 <sup>1</sup> / <sub>4</sub> "	13 <sup>1</sup> / <sub>2</sub> "
2003736	20C-S	20"	31 <sup>1</sup> / <sub>2</sub> "	15"
2003754	22C-S	22"	34 <sup>1</sup> / <sub>2</sub> "	16 <sup>1</sup> / <sub>2</sub> "
2003771	24C-S	24"	37 <sup>3</sup> / <sub>4</sub> "	18"
2003787	26C-S	26"	42"	19 <sup>1</sup> / <sub>2</sub> "
2003802	28C-S	28"	44"	21"
2003814	30C-S	30"	48"	22 <sup>1</sup> / <sub>2</sub> "

## Draft Hood Connector



- The Draft Hood Connector connects Type B gas vent directly to an appliance draft hood.

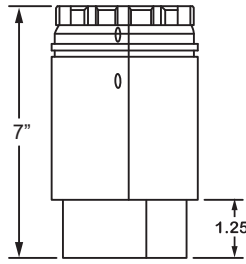

Code	Part #	Size
2003625	10RDC-S	10"
2003643	12RDC-S	12"

## Increaser



- The increaser is used to increase the vent size.
- The maximum increase is 4 sizes.

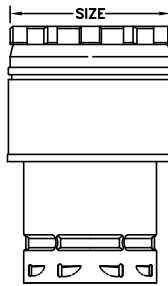

Diameter	Size	Code	Part #	Diameter	Size	Code	Part #	Diameter	Size	Code	Part #
12"	10" to 12"	2003619	10RIX12-S	20"	12" to 20"	2003821	12RIX20-S	26"	18" to 26"	2003715	18RIX26-S
14"	10" to 14"	2003620	10RIX14-S		14" to 20"	2003678	14RIX20-S		20" to 26"	2003732	20RIX26-S
	12" to 14"	2003638	12RIX14-S		16" to 20"	2003695	16RIX20-S		22" to 26"	2003749	22RIX26-S
16"	10" to 16"	2003621	10RIX16-S		18" to 20"	2003712	18RIX20-S		24" to 26"	2003766	24RIX26-S
	12" to 16"	2003639	12RIX16-S	22"	14" to 22"	2003679	14RIX22-S	28"	20" to 28"	2003733	20RIX28-S
	14" to 16"	2003676	14RIX16-S		16" to 22"	2003696	16RIX22-S		22" to 28"	2003750	22RIX28-S
18"	10" to 18"	2003622	10RIX18-S		18" to 22"	2003713	18RIX22-S		24" to 28"	2003767	24RIX28-S
	12" to 18"	2003640	12RIX18-S		20" to 22"	2003730	20RIX22-S		26" to 28"	2003783	26RIX28-S
	14" to 18"	2003677	14RIX18-S	24"	16" to 24"	2003697	16RIX24-S	30"	22" to 30"	2003751	22RIX30-S
16" to 18"	2003694	16RIX18-S	18" to 24"		2003714	18RIX24-S	24" to 30"		2003768	24RIX30-S	
			20" to 24"		2003731	20RIX24-S	26" to 30"		2003784	26RIX30-S	
			22" to 24"		2003748	22RIX24-S	28" to 30"		2003799	28RIX30-S	

## Support Bracket Assembly



- Hangers provide support and resupport for offsets and horizontal.

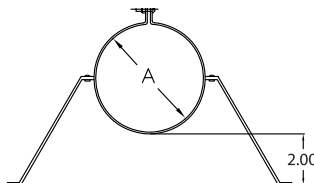

Code	Part #	Pipe Size	A
2003632	8HS-SBA-S	10"	11"
2003650	10FB-SBA-S	12"	13"



## Vent Collar



- The vent collar provides a cover for a rough wall openings.

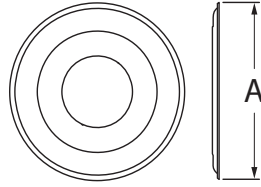

Code	Part #	Size	A
2003824	10RVC-S	10"	18"
2003825	12RVC-S	12"	20"

## Wall Thimble



- Used to install pipe through an interior wall.
- Maintains proper clearance from combustibles.
- The wall thimble adjusts for various wall thicknesses from 4" to 6".

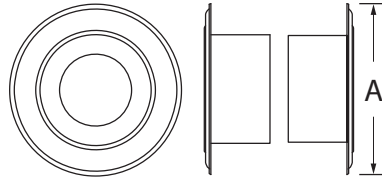

Code	Part #	Size	A
2003826	10RWT-S	10"	11 <sup>1</sup> / <sub>16</sub> "
2003827	12RWT-S	12"	13 <sup>1</sup> / <sub>16</sub> "

## Support Plate

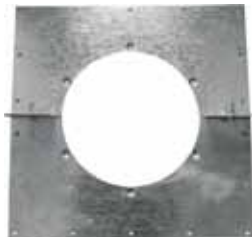

- The support plate is designed to provide strength and durability for supporting large size pipe sections.
- Serves as a firestop.
- Supports up to 30' of pipe.

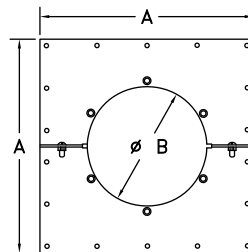

Code	Part #	Size	A	B
2003627	10RSP-S	10"	18"	10 <sup>5</sup> / <sub>16</sub> "
2003645	12RSP-S	12"	20"	12 <sup>7</sup> / <sub>16</sub> "
2003684	14SP-S	14"	22"	14 <sup>5</sup> / <sub>16</sub> "
2003702	16SP-S	16"	24"	16 <sup>5</sup> / <sub>16</sub> "
2003720	18SP-S	18"	26"	18 <sup>5</sup> / <sub>16</sub> "
2003738	20SP-S	20"	28"	20 <sup>5</sup> / <sub>16</sub> "
2003756	22SP-S	22"	30"	22 <sup>5</sup> / <sub>16</sub> "
2003773	24SP-S	24"	32"	24 <sup>5</sup> / <sub>16</sub> "
2003789	26SP-S	26"	34"	26 <sup>5</sup> / <sub>16</sub> "
2003804	28SP-S	28"	36"	28 <sup>5</sup> / <sub>16</sub> "
2003816	30SP-S	30"	38"	30 <sup>5</sup> / <sub>16</sub> "

## Standard Flashing



- Fits flat to 6/12 pitch roof.
- Built with double-seamed construction for protection from leakage.

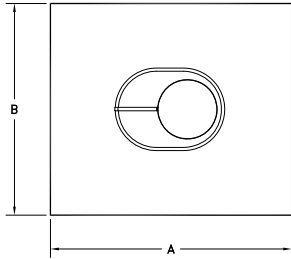

Code	Part #	Size	A	B
2003624	10RF-S	10"	24 <sup>1</sup> / <sub>8</sub> "	24 <sup>1</sup> / <sub>8</sub> "
2003642	12RF-S	12"	25 <sup>1</sup> / <sub>16</sub> "	25 <sup>1</sup> / <sub>16</sub> "
2003681	14F-S	14"	28"	28"
2003699	16F-S	16"	30 <sup>5</sup> / <sub>32</sub> "	30 <sup>1</sup> / <sub>8</sub> "
2003717	18F-S	18"	31 <sup>1</sup> / <sub>2</sub> "	31 <sup>1</sup> / <sub>2</sub> "
2003735	20F-S	20"	34"	34"
2003753	22F-S	22"	34 <sup>1</sup> / <sub>2</sub> "	34 <sup>1</sup> / <sub>2</sub> "
2003770	24F-S	24"	37"	37"
2003786	26F-S	26"	43"	43"
2003801	28F-S	28"	45"	45"
2003813	30F-S	30"	46"	46"

## Tall Cone Flashing



- Used on flat roofs in snow packed areas to reduce chances of snow covering the vent.
- The flashing with a tall cone fits flat to 1/12 roof pitches.

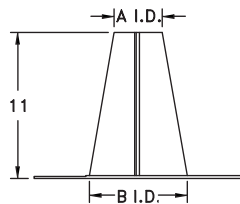
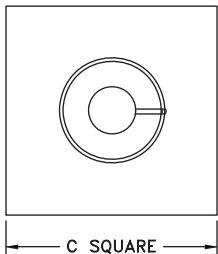

Code	Part #	Size	A I.D.	B O.D.	C
2003631	10RFT-S	10"	11 <sup>1</sup> / <sub>8</sub> "	16"	24 <sup>1</sup> / <sub>8</sub> "
2003649	12RFT-S	12"	13 <sup>1</sup> / <sub>8</sub> "	16"	24 <sup>1</sup> / <sub>8</sub> "
2003688	14FT-S	14"	15 <sup>9</sup> / <sub>16</sub> "	19 <sup>9</sup> / <sub>16</sub> "	27"
2003706	16FT-S	16"	17 <sup>9</sup> / <sub>16</sub> "	19 <sup>9</sup> / <sub>16</sub> "	30"
2003724	18FT-S	18"	19 <sup>9</sup> / <sub>16</sub> "	23 <sup>9</sup> / <sub>16</sub> "	32 <sup>5</sup> / <sub>16</sub> "
2003742	20FT-S	20"	21 <sup>9</sup> / <sub>16</sub> "	23 <sup>9</sup> / <sub>16</sub> "	36"
2003760	22FT-S	22"	23 <sup>9</sup> / <sub>16</sub> "	27 <sup>9</sup> / <sub>16</sub> "	39"
2003777	24FT-S	24"	25 <sup>9</sup> / <sub>16</sub> "	27 <sup>9</sup> / <sub>16</sub> "	40"
2003793	26FT-S	26"	27 <sup>9</sup> / <sub>16</sub> "	31 <sup>9</sup> / <sub>16</sub> "	43"
2003808	28FT-S	28"	29 <sup>9</sup> / <sub>16</sub> "	31 <sup>9</sup> / <sub>16</sub> "	45"
2003820	30FT-S	30"	31 <sup>9</sup> / <sub>16</sub> "	37 <sup>1</sup> / <sub>16</sub> "	46"

## Adjustable Storm Collar



- Used to provide weather strip seal to pipe above flashing.
- Seal the inner edge with sealant against pipe.

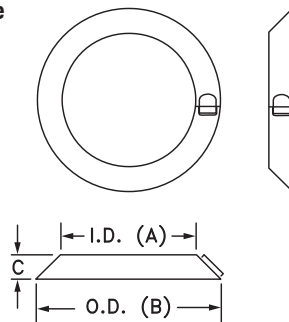

Code	Part #	Size	I.D. (A)	O.D. (B)	C
2003628	10RSC-S	10"	11"	14 <sup>1</sup> / <sub>2</sub> "	1 <sup>3</sup> / <sub>4</sub> "
2003646	12RSC-S	12"	13"	16 <sup>1</sup> / <sub>2</sub> "	1 <sup>3</sup> / <sub>4</sub> "
2003685	14SC-S	14"	15"	18 <sup>1</sup> / <sub>2</sub> "	1 <sup>15</sup> / <sub>16</sub> "
2003703	16SC-S	16"	17"	21 <sup>1</sup> / <sub>4</sub> "	2 <sup>1</sup> / <sub>8</sub> "
2003721	18SC-S	18"	19"	23 <sup>3</sup> / <sub>4</sub> "	2 <sup>5</sup> / <sub>16</sub> "
2003739	20SC-S	20"	21"	25 <sup>15</sup> / <sub>16</sub> "	2 <sup>1</sup> / <sub>2</sub> "
2003757	22SC-S	22"	23"	28 <sup>5</sup> / <sub>16</sub> "	2 <sup>11</sup> / <sub>16</sub> "
2003774	24SC-S	24"	25"	30 <sup>11</sup> / <sub>16</sub> "	1 <sup>7</sup> / <sub>8</sub> "
2003790	26SC-S	26"	27"	33 <sup>1</sup> / <sub>16</sub> "	3 <sup>1</sup> / <sub>16</sub> "
2003805	28SC-S	28"	29"	35 <sup>1</sup> / <sub>16</sub> "	3 <sup>1</sup> / <sub>4</sub> "
2003817	30SC-S	30"	31"	37 <sup>1</sup> / <sub>16</sub> "	3 <sup>7</sup> / <sub>16</sub> "

## Gas Vent Termination Table

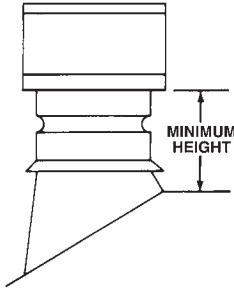

**Caps in 10" through 12" sizes** may be installed in accordance with the Gas Vent Termination Table if the vent is at least 8' from any vertical wall.

**For installation of caps 14" and larger, or for caps that are less than 8' from a vertical wall, the cap is to be located no less than 2' above the highest point where the vent passes through the roof and at least 2' higher than any portion of a building within 10'.**

### 10" and 12" Diameter Caps

Roof Pitch	Minimum Height
flat to $7/12$	1.0 feet
over $7/12$ to $8/12$	1.5 feet
over $8/12$ to $9/12$	2.0 feet
over $9/12$ to $10/12$	2.5 feet
over $10/12$ to $11/12$	3.25 feet
over $11/12$ to $12/12$	4.0 feet
over $12/12$ to $14/12$	5.0 feet
over $14/12$ to $16/12$	6.0 feet
over $16/12$ to $18/12$	7.0 feet
over $18/12$ to $20/12$	7.5 feet
over $20/12$ to $21/12$	8.0 feet

## Gas Vent Offsets Table

This table is used to determine the offset produced by two Selkirk 45° adjustable elbows set at the maximum angle of 45°. Also shown are the offsets produced by introducing various lengths between the two elbows.

### Maximum Offset in Inches

Vent Size	With Two 45° Elbows Only	One 12" Length	One 18" Length	One 24" Length	One 3' Length
10	7 ¼	15	19 ¼	23 ½	32
12	7 ¼	15	19 ¼	23 ½	32
14	8 ½	16 ¼	20 ½	24 ¾	33 ¼
16	9 ¼	17	21 ¼	25 ½	34
18	10	17 ¾	22	26 ¼	34 ¾
20	10 ¼	18	22 ¼	26 ½	35
22	10 ¼	18	22 ¼	26 ½	35
24	11 ¼	19	23 ¼	27 ½	36
26	12	19 ¾	24	28 ¼	36 ¾
28	12 ¾	20 ½	24 ¾	29	37 ½
30	13 ½	21 ¼	25 ½	29 ¾	38 ¼

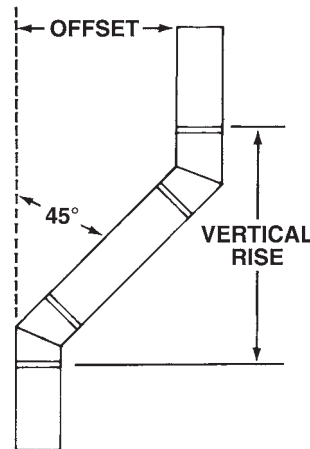

*Note: The vertical rise can also be closely estimated by adding one "A" and one "B" dimension to Maximum Offset figures. (See page 4 for "A" and "B" dimensions of Round Adjustable 45° Elbows.)*

## System Design and Installation Guides

Before laying out a gas vent system for any gas appliance, the installer should first consult the local code and the appliance manufacturer's installation requirements. Only then should you pick components and design the vent system.

Selkirk offers pipe sizes and adjustable components to provide maximum design flexibility.

### TYPE B

Selkirk Type B Gas Vent (Sizes 10" through 30" round) may be installed with the following minimum clearance to combustibles:

- US clearance to combustible all diameters = 1"
- Canada clearance to combustibles
  - 10" - 24" = 1"
  - 26" - 30" = 2"

To graphically illustrate the use of Model R components in typical installations, we offer the diagrams on the next page.

To guide you in these and other installations, the following general rules should be followed.

1. Provide adequate air supply. Remember, you must meet local code minimum requirements for both combustion air and draft hood dilution air.
2. Attach vent to appliance's draft hood or attachment collar with sheet metal screws and terminate the vent at least 5 feet above the draft hood. See Gas Vent Termination Table on page 9 for required height above roof.
3. One gas vent may serve more than one gas appliance. Prudent advance planning (see diagrams on next page) can save you time.
4. Keep offsets and lengths of laterals to a minimum to reduce vent resistance.
5. Strap the vent securely in position, always maintaining appropriate clearance to combustibles. Firestops should be used where vents pass through floors, walls, or ceilings.
6. The vent termination must be securely guyed or braced if it extends more than 5 feet above the roof.
7. For long lasting durability and better appearance, all vents exposed to the weather (except caps) should be painted.
8. Vents installed outside of the structure reduce venting action. Such installations are not recommended.

# Typical Selkirk Type B Gas Vent Installations

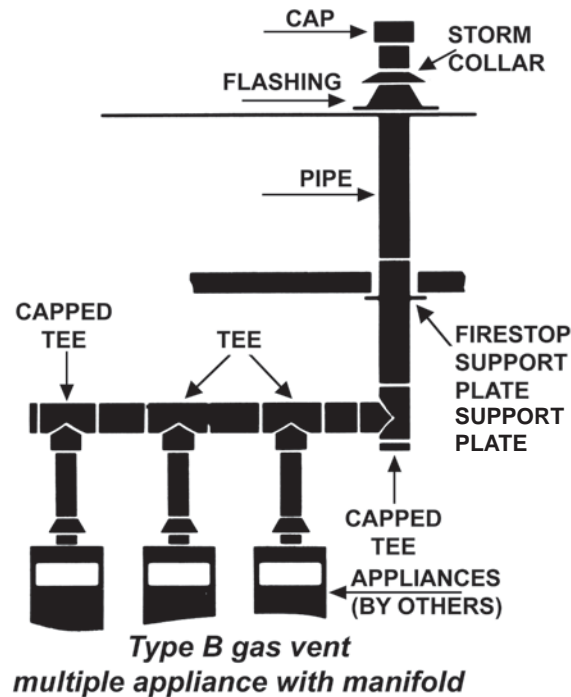
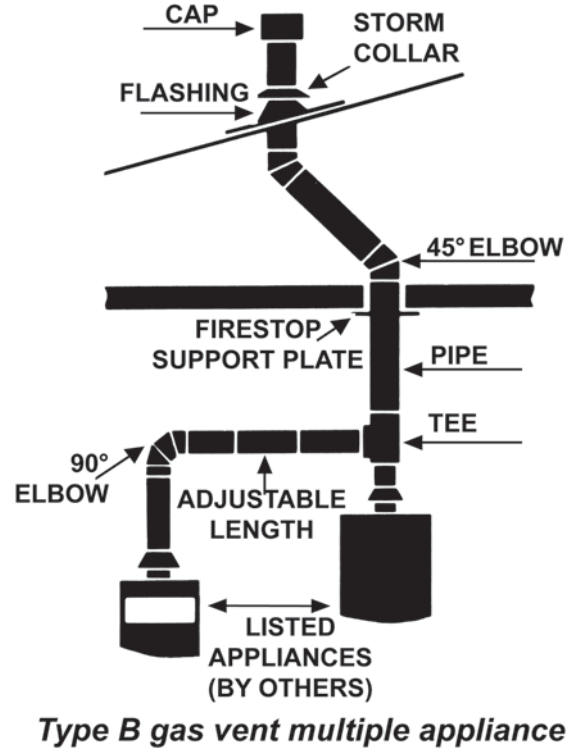
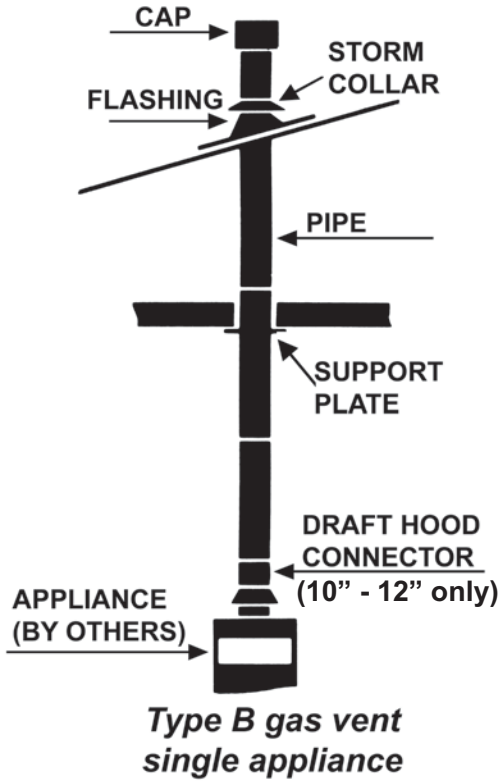

### "SMART CHOICE" LIMITED LIFETIME WARRANTY

Selkirk Corporation, ("Selkirk", "we", "us", "our") warrants our residential Chimney & Venting products (\* defined below) to be free from defects in material and workmanship. For products installed after January 1, 2009, for a period of Ten (10) years from original installation, we will provide replacement product with a similar or like quality of available Selkirk product, free of charge, excluding any installation costs. From the Eleventh (11) through Fifteenth (15) years, we will provide replacement product at a cost of 75% off the published Retail Price in effect on the date the claim is received, excluding any installation costs. At expiration of the Fifteen (15) year term, we will provide replacement product at a cost of 50% off the published Retail Price in effect on the date the claim is received excluding any installation costs. This warranty coverage is non-transferable and applies exclusively to the original consumer.

### PROFESSIONAL INSTALLATION:

If installation is performed by Professional Installers certified in Canada by WETT or APC or in the USA by NFI or CSIA, we will provide replacement product with a similar or like quality of available product, free of charge (excluding any installation costs) for the full Fifteen (15) years from the date of original installation. To be eligible for this additional warranty the consumer must provide a proof of installation by a Professional Installer when submitting a claim.

### LIMITATIONS:

BUYER'S REMEDIES ARE LIMITED TO REPAIR OR REPLACEMENT OF THE PRODUCT AND DO NOT INCLUDE INSTALLATION COSTS. EXCEPT AS SET FORTH HEREIN, ALL OTHER WARRANTIES (EXPRESS OR IMPLIED, INCLUDING THE WARRANTIES OF MERCHANTABILITY AND FITNESS FOR A PARTICULAR PURPOSE) ARE HEREBY DISCLAIMED. IT IS AGREED THAT THIS SHALL BE THE SOLE AND EXCLUSIVE REMEDY OF THE BUYER. IN NO EVENT SHALL WE BE LIABLE FOR ANY CONSEQUENTIAL, SPECIAL OR PUNITIVE DAMAGES ARISING DIRECTLY OR INDIRECTLY FROM THE USE OF THE PRODUCTS WHETHER BASED ON WARRANTY, CONTRACT NEGLIGENCE OR STRICT LIABILITY.

ALL LENGTHS, TEES, ELBOWS, AND COMPONENTS SUPPLIED BY US ARE SUBJECT TO WARRANTY COVERAGE. PRODUCT SUPPLIED BY US AS REPLACEMENT FOR ORIGINAL MATERIAL WILL BE SUBJECT TO A ONE-YEAR WARRANTY COVERAGE WITH THE EXCEPTION OF SAF-T PIPE WHICH IS SUBJECTED TO A 5 YEAR LIMITED WARRANTY COVERAGE FROM DEFECTS IN MATERIAL OR WORKMANSHIP WHEN PROPERLY INSTALLED PURSUANT TO THE MANUFACTURER'S INSTALLATION INSTRUCTIONS AND APPROPRIATE CODES.

**WARNING:** FAILURE TO INSTALL OR OPERATE PRODUCTS ACCORDING TO THE MANUFACTURER'S INSTRUCTIONS, OR FAILURE TO USE PRODUCTS WITH RESIDENTIAL APPLIANCES THAT HAVE BEEN CERTIFIED AT AN ACCREDITED LABORATORY WILL VOID ALL APPLICABLE WARRANTIES.

### THIS WARRANTY DOES NOT COVER:

- (a) any non-stainless base tee unit mounted or connected to an Insulated Chimney system;
- (b) costs (labor or otherwise \*\*) associated with either removing a previously installed product, installing a replacement product, transportation or return of a product, or transportation of replacement product;
- (c) damage to the finish of products caused by the use of improper solvents/chemicals or improper (or lack of) cleaning methods;
- (d) damage resulting from normal wear and tear or failure to reasonably clean, care for or maintain products in accordance with our installation instructions/recommendations;
- (e) damage (to products, appliances or structure) based on or resulting from improper installation or repair, misuse or abuse (including, but not limited to, excessive or improper operating condition), or alteration or adjustment other than in conformity with our installation instructions and specifications, whether performed by a contractor, service company, technician, or yourself;
- (f) any products that have been moved from their original installation site;
- (g) damage caused by burning driftwood, garbage, or any other prohibitive material that has been burned in the appliance served by the chimney;
- (h) damage that results from accidents such as fire, flood, high winds, "acts of God", or any other contingency beyond our control.

\*\* Due to the wide variance in installation practices and other conditions beyond our control, except as stated above, we do not guaranty or in any way warrant the installation of Chimney and Venting products.

**CLAIM PROCEDURE:** If you believe that a product is defective, notify us in writing at:

#### SELKIRK CANADA

P. O. Box 526, Depot 1,  
Hamilton, Ontario, CANADA, L8L 7X6  
ATTN: WARRANTY CLAIMS  
1.888.735.5475  
www.selkirkcorp.com

#### SELKIRK CORPORATION

5030 Corporate Exchange Blvd. SE  
Grand Rapids, MI 49512  
ATTN: WARRANTY CLAIMS  
1.800.433.6341  
www.selkirkcorp.com

Notification should include a description of the product, model and serial number (if applicable) and a description of the product defect. Upon receipt of a written claim under this limited warranty and evidence of the date of purchase or installation, at our option and in our sole discretion, we will provide replacement product with similar or like quality of available product excluding any installation costs. We reserve the right to inspect or investigate any warranty claims prior to determining whether to provide replacement product. If, as determined by us, that repair or replacement of the product is not commercially practicable or cannot be completed in a timely manner, we may refund the prorated purchase price paid for the product upon verification by providing a copy of your invoice or receipt of bill of sale.

\*Selkirk products covered under this warranty: AFCL, ALT, BV (SD, MD, LD), DFS, DSP, DT, DWC/SWC, E, FC (JSC), GT, GTL, PL, QC, R, RF, RV, SAF-T PIPE, SC (JM), SFCL, SPR, ST, U1, UPP, UT, UTL, VP, WV.





Selkirk Canada  
375 Green Road  
Stoney Creek, ON L8E 4A5  
1.888.SELKIRK (735.5475)  
info@selkirkcanada.com



[www.selkirkcorp.com](http://www.selkirkcorp.com)

Selkirk Corporation  
5030 Corporate Exchange Blvd. SE  
Grand Rapids, MI 49512  
Toll Free: 1.800.433.6341  
info@selkirkcorp.com