

INSTALLER: LEAVE THIS MANUAL WITH THE APPLIANCE.
CONSUMER: RETAIN THIS MANUAL FOR FUTURE REFERENCE.
NEVER LEAVE CHILDREN OR OTHER AT RISK INDIVIDUALS ALONE WITH THE APPLIANCE.



INSTALLATION AND OPERATING INSTRUCTIONS

CERTIFIED UNDER CANADIAN AND AMERICAN NATIONAL STANDARDS: CSA C22.2 No-46 / UL 1278 CSA STANDARD

EF30G ELECTRIC FIREPLACE

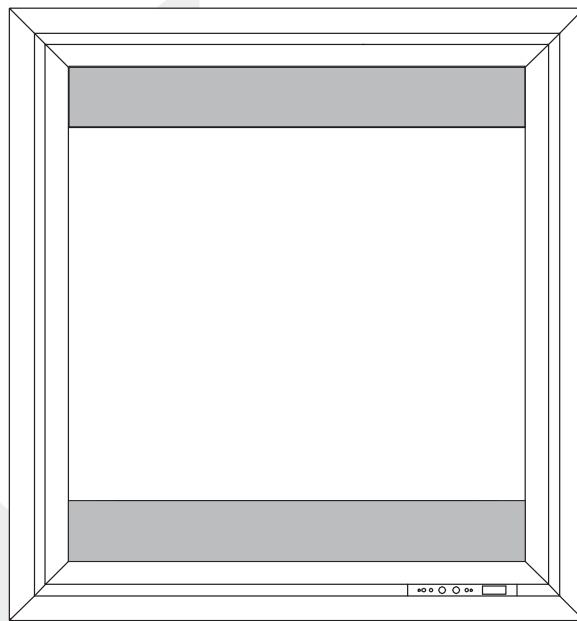

CERTIFIED FOR CANADA AND UNITED STATES USING ANSI/CSA METHODS.

SAFETY INFORMATION

! WARNING

If the information in these instructions are not followed exactly, a fire or explosion may result causing property damage, personal injury or loss of life.

- Do not store or use gasoline or other flammable vapors and liquids in the vicinity of this or any other appliance.

! WARNING



HOT GLASS WILL CAUSE BURNS.

DO NOT TOUCH GLASS UNTIL COOLED.

NEVER ALLOW CHILDREN TO TOUCH GLASS.



APPLY SERIAL NUMBER LABEL FROM CARTON



Wolf Steel Ltd., 24 Napoleon Rd., Barrie, ON, L4M 0G8 Canada /
103 Miller Drive, Crittenden, Kentucky, USA, 41030

Phone (705)721-1212 • Fax (705)722-6031 • www.napoleonfireplaces.com • ask@napoleonproducts.com

TABLE OF CONTENTS

1.0	INTRODUCTION	3
1.1	DIMENSIONS	4
1.2	LISTING APPROVALS	4
1.3	GENERAL INSTRUCTIONS	5
2.0	LOCATING APPLIANCE	6
2.1	UNPACKING AND TESTING APPLIANCE	6
2.2	GROUNDING APPLIANCE	7
3.0	INSTALLATION	8
3.1	MINIMUM CLEARANCE TO COMBUSTIBLES	9
3.2	MINIMUM MANTEL CLEARANCES	9
3.3	NEW CONSTRUCTION OR RENOVATION	10
3.4	INSTALLING THE APPLIANCE	10
3.5	THERMOSTAT AND THERMAL SENSOR INSTALLATION	10
3.6	HARD-WIRE INSTALLATION	11
4.0	FRAMING	13
5.0	FINISHING	14
5.1	HEARTH	14
5.2	COLD CLIMATE INSTALLATION	14
5.3	FINISHING CHECKLIST	14
5.4	GLASS EMBER INSTALLATION	14
6.0	OPERATING INSTRUCTIONS	15
6.1	OPERATING BY REMOTE CONTROL	16
7.0	MAINTENANCE	17
7.1	FLAME GENERATION LAMP REPLACEMENT	18
7.2	EMBER BED LAMP REPLACEMENT	19
7.3	CARE OF GLASS	19
8.0	WIRING DIAGRAM	20
9.0	REPLACEMENT PARTS	21
10.0	TROUBLE SHOOTING	22
11.0	WARRANTY	23
12.0	SERVICE HISTORY	24

NOTE: Changes, other than editorial, are denoted by a vertical line in the margin.

1.0 INTRODUCTION

WARNING

- **THIS APPLIANCE IS HOT WHEN OPERATED AND CAN CAUSE SEVERE BURNS IF CONTACTED.**
- Do not operate appliance before reading and understanding operating instructions. Failure to operate appliance according to operating instructions could cause fire or injury.
- Risk of burns. Power to the appliance should be turned off and the appliance allowed to cool before servicing. To disconnect power to the appliance, turn controls to off, then remove plug from outlet.
- Do not install damaged, incomplete or substitute components.
- Do not burn wood or other materials in this appliance.
- Young children should be carefully supervised when they are in the same room as the appliance. Toddlers, young children and others may be susceptible to accidental contact burns. A physical barrier is recommended if there are at risk individuals in the house. To restrict access to an appliance or stove, install an adjustable safety gate to keep toddlers, young children and other at risk individuals out of the room and away from hot surfaces.
- Clothing or other flammable material should not be placed on or near the appliance.
- Due to high temperatures, the appliance should be located out of traffic and away from furniture and draperies.
- Ensure you have incorporated adequate safety measure to protect infants/toddlers from touching hot surfaces.
- Even after the appliance is out, the glass and/or screen will remain hot for an extended period of time.
- Check with your local hearth specialty dealer for safety screens and hearth guards to protect children from hot surfaces. These screens and guards must be fastened to the floor.
- Any safety screen or guard removed for servicing must be replaced prior to operating the appliance.
- It is imperative that the control compartments, circulating blower and its passageway in the appliance and are kept clean. The appliance should be inspected before use and at least annually by a qualified service person. More frequent cleaning may be required due to excessive lint from carpeting, bedding material, etc. The appliance area must be kept clear and free from combustible materials, gasoline and other flammable vapors and liquids.
- Under no circumstances should this appliance be modified.
- Do not use this appliance if any part has been under water. Immediately call a qualified service technician to inspect the appliance and to replace any part of the control system which has been under water.
- Do not operate the appliance with the glass door removed, cracked or broken. Replacement of the glass should be done by a licensed or qualified service person.
- Do not strike or slam shut the appliance glass door.
- Keep the packaging material out of reach of children and dispose of the material in a safe manner. As with all plastic bags, these are not toys and should be kept away from children and infants.
- Servicing should be done only while the appliance is disconnected from the power supply circuit.
- Always unplug appliance when not in use.
- Do not operate this appliance with a damaged cord or plug after the appliance malfunctions, has been dropped or damaged in any manner. Return appliance to authorized service facility for examination, electrical or mechanical adjustment, or repair.
- Do not use outdoors.
- Never locate appliance where it may fall into a bathtub or other water container.
- Do not run cord under carpeting. Do not cover cord with throw rugs, runners, or the like. Arrange cord away from traffic area and where it will not be tripped over.
- Connect to properly grounded outlets only.
- Do not insert or allow foreign objects to enter any ventilation or exhaust opening as this may cause an electric shock or fire, or damage the appliance.
- To prevent a possible fire, do not block air intakes or exhaust in any manner. Do not use on soft surfaces, like a carpet, where openings may become blocked.
- Always plug appliances directly into a wall outlet/receptacle. Never use an extension cord or relocatable power tap (outlet/power strip).
- Ensure clearances to combustibles are maintained when building a mantel or shelves above the appliance. Elevated temperatures on the wall or in the air above the appliance can cause melting, discolouration or damage to decorations, a T.V. or other electronic components.

3.7C

1.1 DIMENSIONS

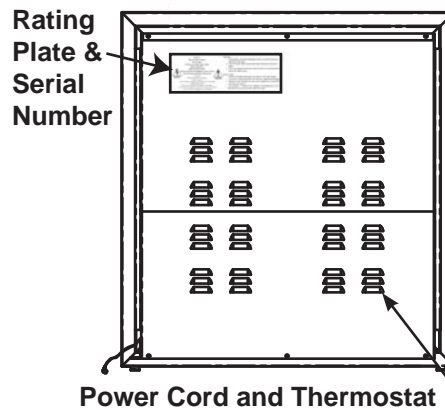
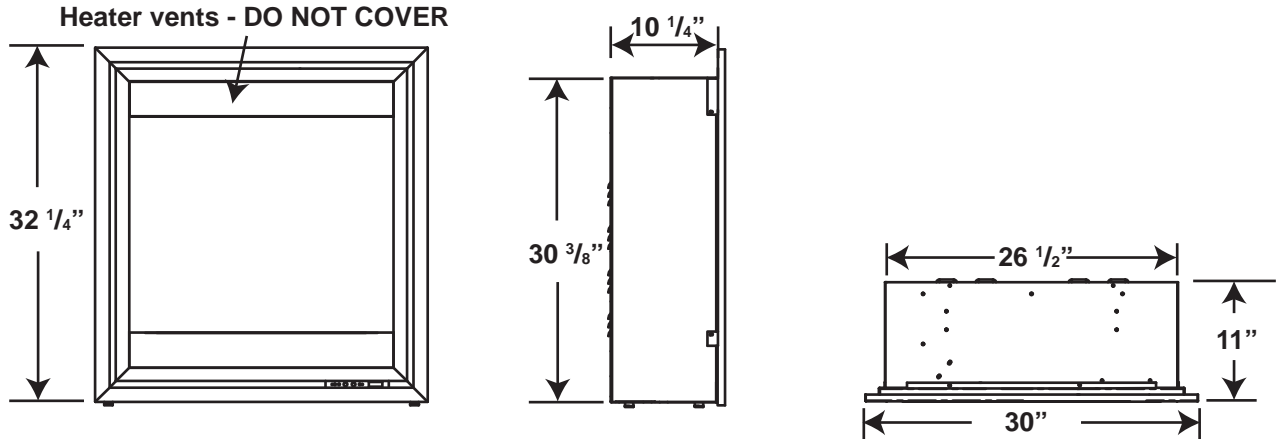

1.2 LISTING APPROVALS

This appliance has been tested in accordance with the CSA Standards for fixed and location-dedicated electric room appliances in the United States and Canada. If you need assistance during installation, please contact your local dealer.

Model Number	EF30G
Description	Electric Appliance
Voltage	120V AC
Watts	MAX 1500W
Amps	15 AMP
Appliance Width	30" (762mm)
Appliance Height	32 1/4" (820mm)
Appliance Depth	11" (280mm)
Net Weight	75 lbs (34kgs)
Gross Weight	88 lbs (40kgs)

NOTE: This appliance must be electrically wired and grounded in accordance with local codes or, in the absence of local codes, with National Electric Code ANSI/NFPA 70-latest edition or the Canadian Electric Code, CSA C22.1 as appropriate.

1.3 GENERAL INSTRUCTIONS

! WARNING
READ THESE INSTRUCTIONS COMPLETELY BEFORE BEGINNING INSTALLATION. FAILURE TO FOLLOW THEM COULD CAUSE AN APPLIANCE MALFUNCTION RESULTING IN SERIOUS INJURY AND/OR PROPERTY DAMAGE.
ALL ELECTRIC APPLIANCES HAVE HOT AND ARCING OR SPARKING PARTS INSIDE. DO NOT USE IT IN AREAS WHERE GASOLINE, PAINT OR FLAMMABLE LIQUIDS ARE PRESENT.
THIS ELECTRIC APPLIANCE IS TESTED AND LISTED FOR USE ONLY WITH THE OPTIONAL ACCESSORIES LISTED IN THESE INSTRUCTIONS. USE OF OPTIONAL ACCESSORIES NOT SPECIFICALLY TESTED FOR THIS ELECTRIC APPLIANCE COULD VOID THE WARRANTY AND/OR RESULT IN A SAFETY HAZARD.
DO NOT OPEN. RISK OF ELECTRIC SHOCK. NO USER-SERVICEABLE PARTS INSIDE.
DO NOT USE DAMAGED ELECTRICAL CORDS.
SERVICING SHOULD BE DONE ONLY WHILE THE APPLIANCE IS DISCONNECTED FROM THE POWER SUPPLY CIRCUIT.
HIGH TEMPERATURE, RISK OF FIRE. KEEP ELECTRICAL CORDS, DRAPERY, FURNISHINGS, AND OTHER COMBUSTIBLES AT LEAST 3 FEET (0.9M) FROM THE FRONT OF THE APPLIANCE AND AWAY FROM SIDES AND REAR.
TO PREVENT ELECTRIC SHOCK MATCH THE WIDE BLADE OF PLUG TO WIDE SLOT OF RECEPTACLE AND FULLY INSERT.

This electric appliance meets the construction and safety standards of H.U.D. for application in manufactured homes when installed according to these instructions.

- A. Prior to plugging your appliance into an electrical outlet, verify that the house circuit breakers for the outlet are on.
- B. The appliance may emit a slight, harmless odour when first used. This odour is normal and it is caused by the initial heating of internal appliance elements and will not occur again.
- C. If your appliance does not emit heat, consult the operation section of this manual for further information.
- D. Use with a CSA or UL certified surge protector.

2.0 LOCATING APPLIANCE

! WARNING
DUE TO HIGH TEMPERATURES, THIS ELECTRIC APPLIANCE SHOULD BE LOCATED OUT OF TRAFFIC. KEEP COMBUSTIBLE MATERIALS SUCH AS FURNITURE, PILLOWS, BEDDING, PAPERS, CLOTHES AND CURTAINS AT LEAST 3 FEET (0.9M) FROM THE FRONT OF THE APPLIANCE.
NEVER LOCATE THIS ELECTRIC APPLIANCE WHERE IT MAY FALL INTO A BATHTUB OR OTHER WATER CONTAINER.
WEAR SAFETY GLOVES AND SAFETY GLASSES FOR PROTECTION DURING INSTALLATION AND MAINTENANCE.
TO PREVENT CONTACT WITH SAGGING OR LOOSE INSULATION, THE ELECTRIC APPLIANCE MUST NOT BE INSTALLED AGAINST VAPOR BARRIER OR EXPOSED INSULATION. LOCALIZED OVERHEATING COULD OCCUR AND A FIRE COULD RESULT.

NOTICE

Minimum clearance of 1" on all sides, back and top must be maintained at all times. Illustrations throughout these instructions reflect typical installations and are for design purposes only. Actual installations may vary slightly due to individual preferences.

Illustrated is a variety of ways the appliance may be located in a room. The appliance may be installed directly on the floor (uncarpeted), or raised on a hearth.

TOP VIEW SHOWING APPROVED ROOM LOCATIONS OF FIREPLACE

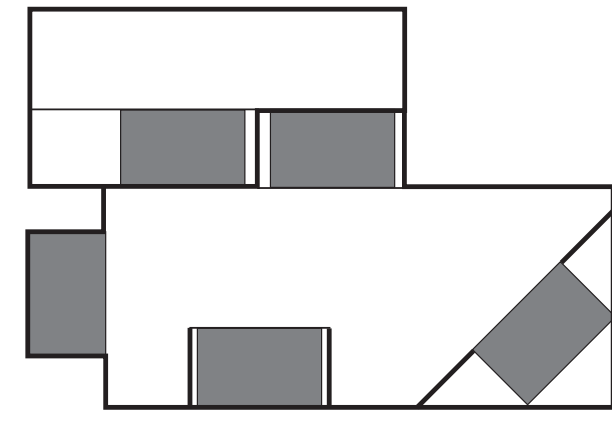

2.1 UNPACKING AND TESTING APPLIANCE

Carefully remove the appliance from the box. Prior to installing the appliance, test to make sure the appliance operates properly by plugging the power supply cord into a conveniently located 120 Volt grounded outlet.

2.2 GROUNDING APPLIANCE

This appliance is for use on 120 Volts. The cord has a plug as shown in (A). An adapter as shown in (C) is available for connecting three-blade grounding type plugs to two-slot receptacles. The green grounding lug extending from the adapter must be connected to a permanent ground such as a properly grounded outlet box. The adapter should not be used if a three-slot grounded receptacle is available.

To disconnect appliance, turn controls to off, then remove plug from outlet.

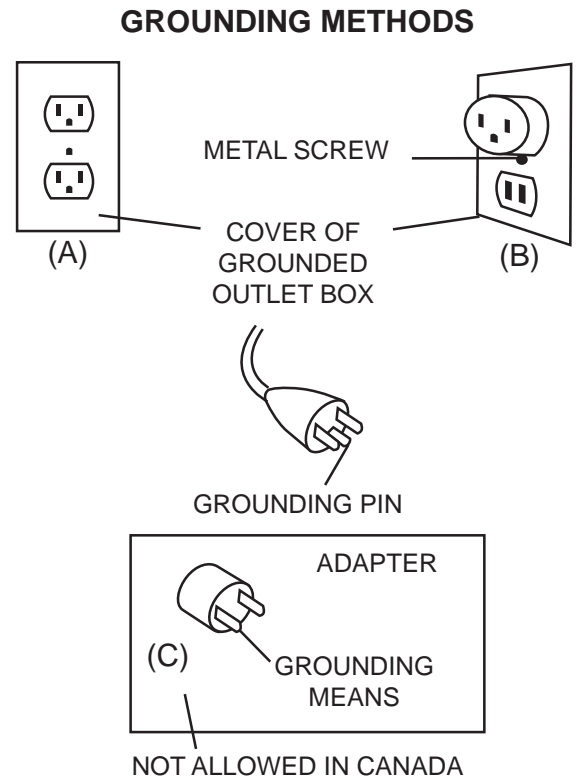

3.0 INSTALLATION

 WARNING
RISK OF FIRE! THE POWER CORD MUST NOT BE PINCHED AGAINST A SHARP EDGE. SECURE CORD TO AVOID TRIPPING OR SNAGGING TO REDUCE THE RISK OF FIRE, ELECTRIC SHOCK OR PERSONAL INJURY. DO NOT RUN CORD UNDER CARPETING. DO NOT COVER CORD WITH THROW RUGS, RUNNERS OR THE LIKE. ARRANGE CORD AWAY FROM TRAFFIC AREAS AND WHERE IT WILL NOT BE TRIPPED OVER.
RISK OF FIRE! TO PREVENT A POSSIBLE FIRE, DO NOT BLOCK AIR INTAKE OR EXHAUST IN ANY MANNER. DO NOT USE ON SOFT SURFACES WHERE OPENINGS MAY BECOME BLOCKED.
RISK OF FIRE! DO NOT BLOW OR PLACE INSULATION AGAINST THE APPLIANCE.
THIS ELECTRIC APPLIANCE IS TESTED AND LISTED FOR USE ONLY WITH THE APPROVED OPTIONAL ACCESSORIES. USE OF OPTIONAL ACCESSORIES NOT SPECIFICALLY TESTED FOR THIS ELECTRIC APPLIANCE COULD VOID THE WARRANTY AND/OR RESULT IN A SAFETY HAZARD.
IF THE INFORMATION IN THESE INSTRUCTIONS IS NOT FOLLOWED EXACTLY, A FIRE OR EXPLOSION MAY RESULT CAUSING PROPERTY DAMAGE, PERSONAL INJURY OR DEATH. DO NOT STORE OR USE GASOLINE OR OTHER FLAMMABLE VAPORS IN THE VICINITY OF THIS OR ANY OTHER APPLIANCE.
THIS APPLIANCE MUST REMAIN REMOVABLE FROM THE ENCLOSURE. THE APPLIANCE MAY BE HARD WIRED, BUT IT IS RECOMMENDED THAT IT BE PLUGGED INTO A STANDARD OUTLET USING THE SUPPLIED POWER CORD. THIS APPLIANCE MUST NOT BE SEALED AROUND THE FRONT FACING.
APPLIANCE VENTS LOCATED ON THE FRONT AND BACK OF THIS ELECTRIC APPLIANCE CANNOT, IN ANY WAY, BE COVERED AS IT MAY CREATE A FIRE HAZARD.

BEFORE INSTALLATION

Select a suitable location that is not susceptible to moisture and is away from drapes, furniture and high traffic areas. **NOTE: Follow all national and local electrical codes. This appliance can be installed into either an existing fireplace opening or as new construction / renovation.**

EXISTING APPLIANCE INSTALLATION

Thoroughly clean out the existing fireplace and hearth area.

Plan the power supply. If an existing grounded outlet is near the appliance, the power cord can run behind the appliance. If the cord is not long enough to reach the outlet, a grounded extension cord minimum AWG No. 14 and rated to a minimum of 1875 watts may be used. If you plan to cut or drill a hole in the existing fireplace for wiring, it is best to hire a professional to do this step in order to prevent personal injury. To reduce the risk of fire, do not run the power cord under rugs, carpets, etc. Arrange the power supply cord away from high traffic areas where it may pose a tripping hazard.

3.1 MINIMUM CLEARANCE TO COMBUSTIBLES

! WARNING

THIS APPLIANCE MUST REMAIN REMOVABLE FROM THE ENCLOSURE. THE APPLIANCE MAY BE HARD WIRED, BUT IT IS RECOMMENDED THAT IT BE PLUGGED INTO A STANDARD OUTLET USING THE SUPPLIED POWER CORD. THIS APPLIANCE MUST NOT BE SEALED AROUND THE FRONT FACING.

APPLIANCE VENTS LOCATED ON THE FRONT AND BACK OF THIS ELECTRIC APPLIANCE CANNOT, IN ANY WAY, BE COVERED AS IT MAY CREATE A FIRE HAZARD.

Sides, back, top	1"
------------------	----

3.2 MINIMUM MANTEL CLEARANCES

! WARNING

RISK OF FIRE, MAINTAIN ALL SPECIFIED AIR SPACE CLEARANCES TO COMBUSTIBLES. FAILURE TO COMPLY WITH THESE INSTRUCTIONS MAY CAUSE A FIRE OR CAUSE THE APPLIANCE TO OVERHEAT. ENSURE ALL CLEARANCES (I.E. BACK, SIDE, TOP, VENT, MANTEL, FRONT, ETC.) ARE CLEARLY MAINTAINED.

WHEN USING PAINT OR LACQUER TO FINISH THE MANTEL, THE PAINT OR LACQUER MUST BE HEAT RESISTANT TO PREVENT DISCOLOURATION.

73.1

The minimum distance from the top of the appliance that the mantel can be installed is 10", at any depth.

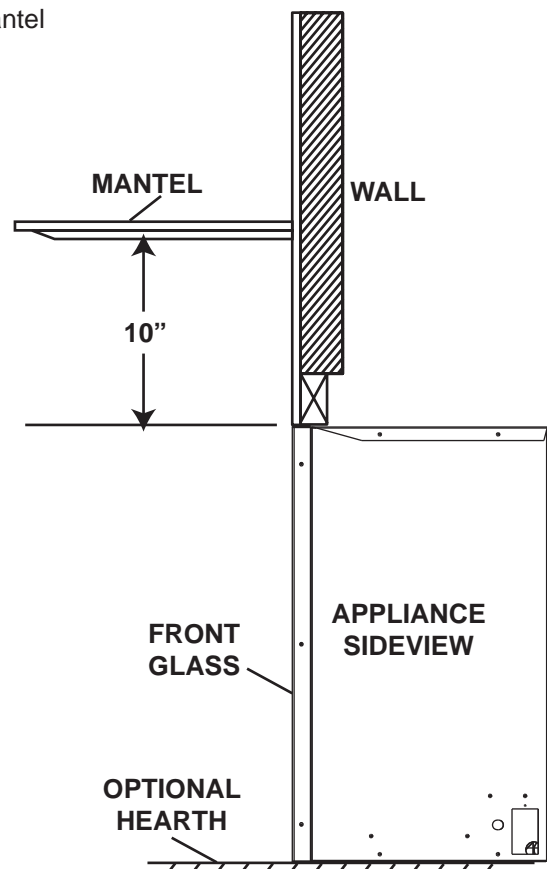

3.3 NEW CONSTRUCTION OR RENOVATION

- A. Select a location that is not prone to moisture and is located at least 0.9 m or 3 feet away from combustible materials such as curtains or drapes, furniture, bedding, paper, etc.
- B. Place the appliance in selected location to see how it will look in the future.
- C. Mark the desired location on the floor and store appliance in a safe, dry and dust free location.
- D. Frame in an opening leaving at least 1/4" (6 mm) around the edge of the appliance. Any new wiring must be done in compliance with local and national codes and other applicable regulations in order to reduce the risk of fire, electric shock or other injuries. Therefore, it is strongly recommended that you hire a professional to complete any such work.

3.4 INSTALLING THE APPLIANCE

- A. Once the site has been prepared, the appliance can be installed.
- B. Make sure the main power switch is in the "OFF" position.
- C. Plug the appliance into a 15-amp/120 Volt, grounded outlet. Use a CSA or UL approved surge protector.
- D. Push in the appliance so that the trim is against the finished mantel or wall surface.

3.5 THERMOSTAT AND THERMAL SENSOR INSTALLATION

This appliance has two options for heat control.

First is a thermal controlled sensor, which comes plugged into the appliance beside the main power cord. This sensor has no user temperature set points, it will turn off the heater when the sensor reaches its pre-set point, and will only turn the heater back on when it has cooled back down below this set point. On the low setting (green light) the set point is 16°C/61°F, on medium (orange light) 22°C/72°F and on high (red light) 28°C/82°F. This small sensor can be placed anywhere in the room within the length of the sensor wire, but it should not be placed near the top or front of the appliance. Placing the sensor too close to the heater area of the appliance will cause unwanted cycling of the heater.

Second is the option of a wall-mounted thermostat. Napoleon Part # W690-0001, W660-0081, or an equivalent low voltage thermostat.

A wall thermostat can be used in place of the thermal control sensor. You must first remove the sensor by unplugging it from the right side of the appliance beside the main power cord. Replace the sensor with the wire harness provided in the manual baggie. Plug it into the appliance and connect the other end to the thermostat. The thermostat should be placed as per the thermostat installation instructions.

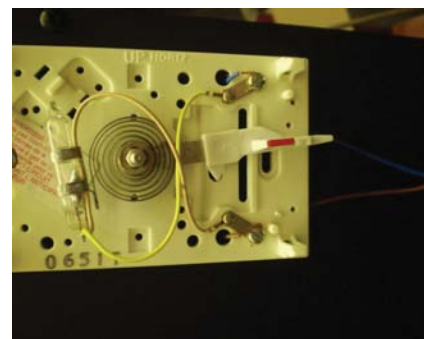

3.6 HARD-WIRE INSTALLATION



ENSURE ALL POWER IS TURNED OFF BEFORE HARD WIRING THIS APPLIANCE.

HARD WIRING CONNECTION

If it is necessary to hard wire this appliance, a qualified electrician may remove the cord connection, and wire the appliance directly to the house hold wiring.

This appliance must be electrically connected and grounded in accordance with local codes, if hard wired. In the absence of local codes, use the current CSA C22.1 CANADIAN ELECTRICAL CODE in Canada or the current ANSI/NFPA 70 NATIONAL ELECTRICAL CODE in the United States.

- A. Remove cover plate located beside the power cord to reveal the 7/8" wire hole. Discard cover plate, screws and insert a box connector into the hole.
- B. Remove the lower back panel from the appliance to expose wiring.
- C. Remove the power cord strain-relief from the side of the appliance and cut the cord where shown below. This will be the hard wire connection point.
- D. Feed the supply wires through the box connector and the grommet.
- E. Using wire connectors connect the common (white) wires together, then the hot (black) wires, and then the ground (green) wires.
- F. Ensure the newly connected wires are kept away from the rotating parts and the circuit board, and re-install the back panel.

NOTE: This appliance must be serviced from the back, leave enough wire so that the appliance can be removed from the enclosure without disconnecting the power supply wires.

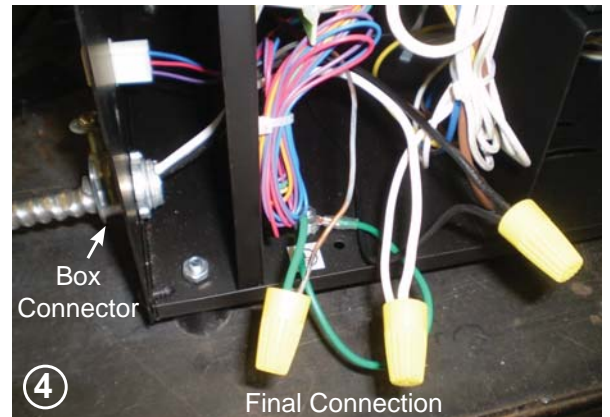
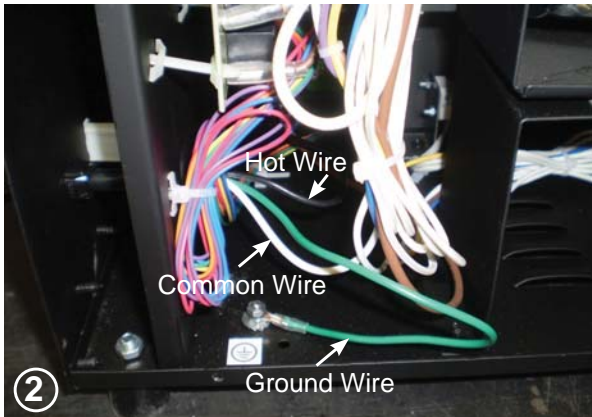
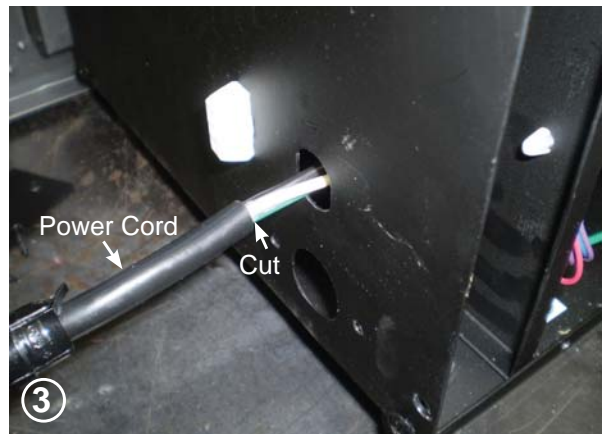
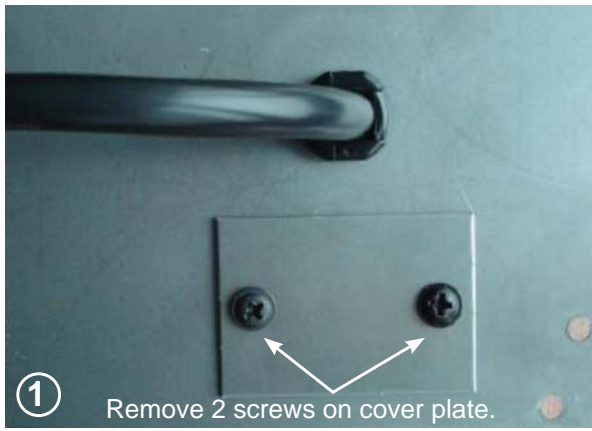

4.0 FRAMING

 WARNING RISK OF FIRE!
<p>IN ORDER TO AVOID THE POSSIBILITY OF EXPOSED INSULATION OR VAPOUR BARRIER COMING IN CONTACT WITH THE APPLIANCE BODY, IT IS RECOMMENDED THAT THE WALLS OF THE APPLIANCE ENCLOSURE BE “FINISHED” (IE: DRYWALL / SHEETROCK), AS YOU WOULD FINISH ANY OTHER OUTSIDE WALL OF A HOME. THIS WILL ENSURE THAT CLEARANCE TO COMBUSTIBLES IS MAINTAINED WITHIN THE CAVITY.</p>
<p>DO NOT NOTCH THE FRAMING AROUND THE APPLIANCE STAND-OFFS. FAILURE TO MAINTAIN AIR SPACE CLEARANCE MAY CAUSE OVER HEATING AND FIRE. PREVENT CONTACT WITH SAGGING OR LOOSE INSULATION OR FRAMING AND OTHER COMBUSTIBLE MATERIALS. BLOCK OPENING INTO THE CHASE TO PREVENT ENTRY OF BLOWN-IN INSULATION. MAKE SURE INSULATION AND OTHER MATERIALS ARE SECURED.</p>
<p>WHEN CONSTRUCTING THE ENCLOSURE ALLOW FOR FINISHING MATERIAL THICKNESS TO MAINTAIN CLEARANCES. FRAMING OR FINISHING MATERIAL CLOSER THAN THE MINIMUMS LISTED MUST BE CONSTRUCTED ENTIRELY OF NON-COMBUSTIBLE MATERIALS. MATERIALS CONSISTING ENTIRELY OF STEEL, IRON, BRICK, TILE, CONCRETE, SLATE, GLASS OR PLASTERS, OR ANY COMBINATION THEREOF ARE SUITABLE. MATERIALS THAT ARE REPORTED AS PASSING ASTM E 136, STANDARD TEST METHOD FOR BEHAVIOUR OF MATERIALS IN A VERTICAL TUBE FURNACE AT 750°C AND UL763 SHALL BE CONSIDERED NON-COMBUSTIBLE MATERIALS.</p>
<p>MINIMUM CLEARANCE TO COMBUSTIBLES MUST BE MAINTAINED OR A SERIOUS FIRE HAZARD COULD RESULT.</p>
<p>THE APPLIANCE REQUIRES A MINIMUM ENCLOSURE HEIGHT. MEASURE FROM THE APPLIANCE BASE.</p>
<p>IF STEEL STUD FRAMING KITS WITH CEMENT BOARD ARE PROVIDED, THEY MUST BE INSTALLED.</p>

71.1

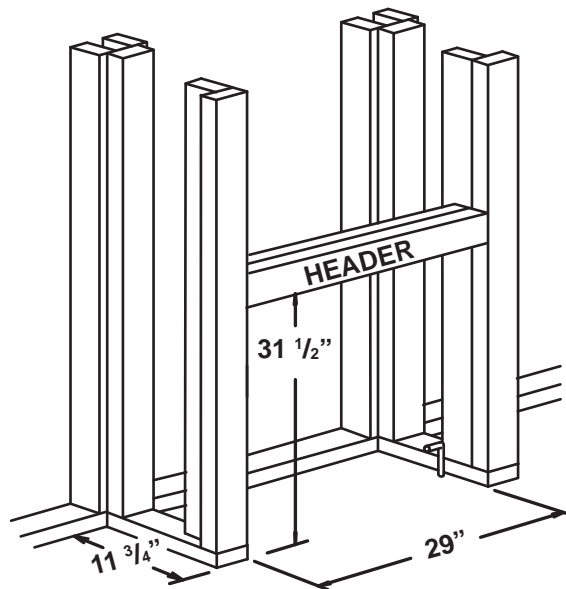

5.0 FINISHING

! WARNING
RISK OF FIRE!
NEVER OBSTRUCT THE FRONT OPENING OF THE APPLIANCE.
DO NOT STRIKE, SLAM OR SCRATCH GLASS. DO NOT OPERATE APPLIANCE WITH GLASS REMOVED, CRACKED, BROKEN OR SCRATCHED.
FACING AND/OR FINISHING MATERIAL MUST NEVER OVERHANG INTO THE APPLIANCE OPENING.

5.1 HEARTH

A hearth is NOT necessary but is recommended for aesthetic purposes.

5.2 COLD CLIMATE INSTALLATION

! WARNING
IT IS MANDATORY TO HAVE AN INSULATED WALL BEHIND THE APPLIANCE, WHEN THE APPLIANCE IS BEING INSTALLED ON AN OUTSIDE WALL OR CHASE.

5.3 FINISHING CHECKLIST

- A. Power supply service must be completed prior to finishing to avoid reconstruction.
- B. Appliance vents and air openings cannot be covered in any circumstances.

5.4 GLASS EMBER INSTALLATION

! WARNING
GLASS FRONT MUST BE REMOVED AND THE APPLIANCE MUST BE INSTALLED IN IT'S FINAL LOCATION BEFORE THE GLASS MEDIA IS INSTALLED.
GLASS MEDIA MAY HAVE SHARP EDGES, WEAR SAFETY GLASSES AND GLOVES WHEN HANDLING.
CLEAN THE GLASS MEDIA PRIOR TO INSTALLATION. BEFORE APPLYING THE CLEANED GLASS, ENSURE THAT IT IS DRY.
DO NOT CHANGE OR SUBSTITUTE THE GLASS MEDIA MATERIAL PROVIDED WITH THIS APPLIANCE. IF REPLACING, USE ONLY THE REPLACEMENT GLASS MEDIA AVAILABLE FROM YOUR AUTHORIZED DEALER / DISTRIBUTOR.

- A. To remove the glass front, remove the two bottom screws as illustrated below.
- B. Lift the front up and pull forward and off. Set the front in a location where it will not be knocked over or damaged.
- C. Carefully distribute the glass embers into the bottom tray on the front of the appliance as illustrated.
NOTE: Glass media may have a fine oil residue that needs to be cleaned prior to installation. Clean the glass with mild dish soap, drain, rinse thoroughly and dry before placing it in the appliance
- D. Re-install the glass front using the two securing screws.



6.0 OPERATING INSTRUCTIONS

The controls are located on the bottom right corner of the appliance.

A. Plug in your electric appliance.

B. Main ON/OFF Power Switch and LED:

This switch is located on the right side of the control panel. The "I" indicates ON and "O" indicates OFF.

When the appliance is first turned on, the default settings are as follows:

- Ember bed: HIGH
- Flame: HIGH
- Appliance: OFF

C. Temperature Control Button and LED:

The Appliance LED is located to the right of the FLAME Button. Push the TEMP button to cycle through different appliance settings. Press and release the TEMP button to cycle through LO, MED, HI and OFF. Each time the TEMP button is pushed, the Appliance LED will change to its corresponding color: Green for LO (approximately 16°C / 61°F), Orange for MED (approximately 22°C / 72°F), Red for HI (approximately 28°C / 82°F), and blank for OFF. When the appliance is turned on, heat will emit through the vents located in the middle of the top louvre panel. The appliance has a built-in thermostat so it will shut off automatically once the pre-set temperature is reached. It will also turn on automatically if the room temperature drops below the pre-set temperature. **NOTE: When the appliance is turned on for the first time, it may release a slight, harmless odour. This odour is a normal occurrence caused by the initial heating of the internal heating elements and should not occur again.**





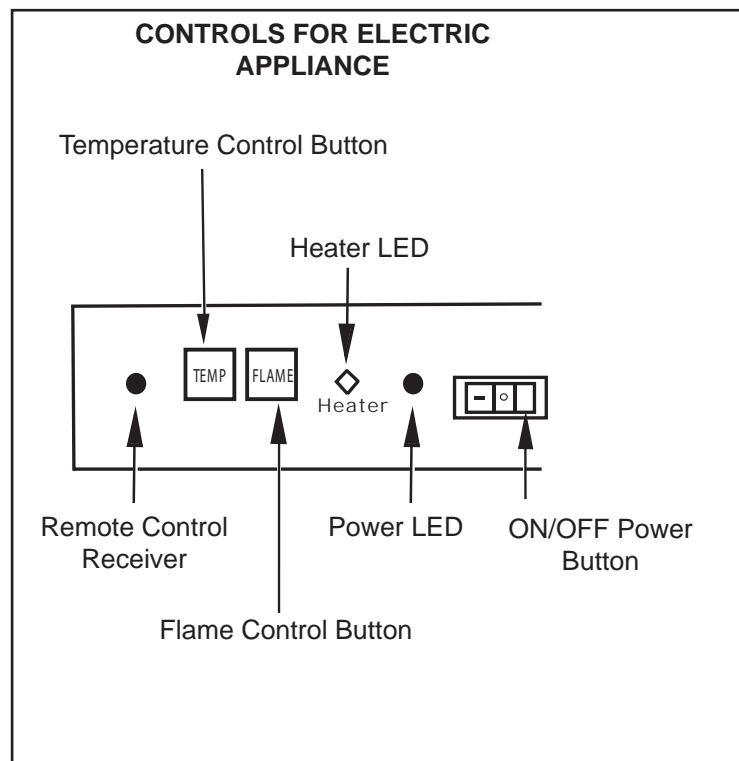







D. Flame Control Button:

This button is located to the right of the TEMP Button. After power is turned on, push the FLAME control button to adjust the flame and ember bed brightness. Press and release the Flame Control Button to cycle through LO, MED, HI and OFF.



6.1 OPERATING BY REMOTE CONTROL

Once the appliance has been plugged in to a grounded electrical outlet, it is ready to operate.

- A. Plug in your electric appliance.
- B. Make sure the appliance's main power button  is at the ON position! The remote control will NOT work if the main Power button is at the OFF position. **NOTE: Ensure the house circuit breakers for the power supply are turned on. In the event of a power failure, when the main switch is in the ON position and the hand held remote control is in the OFF position, the flame generation lights will come on at the high setting, however the heater remains turned off when the power is restored.**
- C. When operating the remote control, it must be directed towards the front of the appliance.
- D. The button at the top left corner of the remote is the main power button . Pressing this button activates the power to the appliance. **NOTE: The main power switch on the appliance must be in the ON position for the remote to operate.**
- E. To adjust the ember bed brightness, press the  "+" or "-" buttons. To increase the ember bed brightness, press the  "+" button, to decrease the ember bed brightness, press the  "-" button. There are seven levels of brightness.
- F. To activate the heater, press the  button. Press and release the  button to cycle through LO, MED, HI and OFF. Each time the  button is pushed, the appliance LED will change to its corresponding color: Green for LO, Orange for MED, Red for HI, and blank for OFF. The appliance has a built-in thermostat so it will shut off automatically once the pre-set temperature is reached. It will also turn on automatically if the room temperature drops below the pre-set temperature.
- G. To adjust the height of the flame, press the  "+" or "-" buttons. To increase the height of the flame, press the  "+" button, to decrease the height of the flame, press the  "-" button. There are seven levels of flame effects.
- H. To turn off the appliance, press the  button once. **NOTE: This remote control must remain within 8 meters or 26 feet of the appliance to be effective and this range may be reduced as the battery power is depleted.**

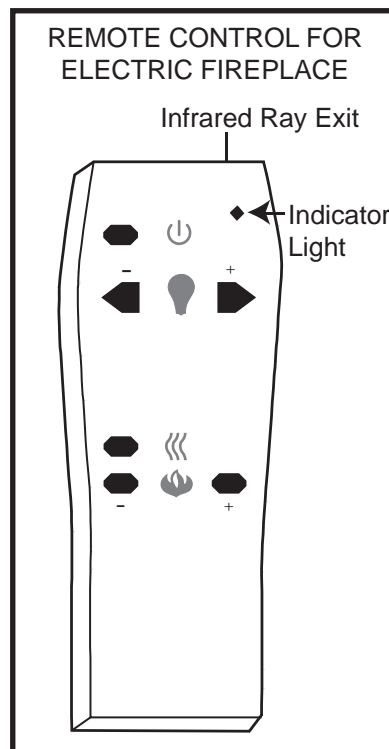

NOTE: Make sure your batteries are fully charged and installed correctly in your remote control.

7.0 MAINTENANCE

! WARNING
ALWAYS DISCONNECT THE POWER AND ALLOW THE ELECTRIC APPLIANCE TO COOL BEFORE PERFORMING ANY CLEANING, MAINTENANCE OR RELOCATION OF THIS ELECTRIC APPLIANCE. TURN CONTROLS TO OFF AND REMOVE PLUG FROM OUTLET OR TURN OFF THE HOUSE CIRCUIT BREAKER TO ELECTRIC APPLIANCE RECEPTACLE.
DO NOT INSTALL REPLACEMENT BULBS THAT EXCEED SPECIFIED MAXIMUM WATTS.
THE HALOGEN LIGHT BULBS IN YOUR UNIT CAN BECOME EXTREMELY HOT. ALLOW AT LEAST 10 MINUTES BETWEEN TURNING OFF THE APPLIANCE AND REMOVING THE LIGHT BULBS TO AVOID ACCIDENTAL BURNS. DO NOT HANDLE THE LAMP (BULBS) WITH BARE FINGERS, OILS FROM YOUR SKIN WILL DAMAGE THE BULBS WHEN THEY HEAT UP. USE GLOVES OR A CLEAN DRY CLOTH WHEN HANDLING BULBS.

Most halogen lamps are rated to last approximately 1800 hours. Like all lamps, halogen lamps require periodic replacement. When the lamps in your appliance have burned out, you will notice one or more of following:

COMMON OBSERVED PROBLEMS:

- There is no flame
- Flame or Ember bed is dim or dark in certain areas
- Flame is not moving or glowing

Your appliance must be opened in order to replace the lamp. To reduce the number of times you need to open the appliance, replace all lamps at the same time if they are close to the end of their rated life.

There are a total of 8 halogen lamps (Type G6.35, rated 120Volts, 35Watts) supplied with your appliance:

- 2 lamps provide illumination for the ember bed
- 2 lamps provide illumination for flame generation
- 4 extra lamps for replacement

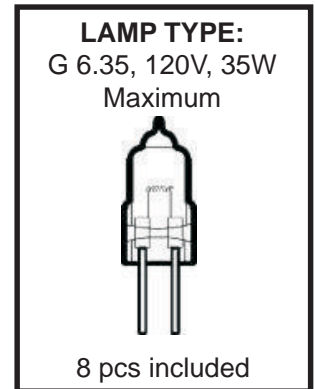

7.1 FLAME GENERATION LAMP REPLACEMENT

- A. Remove the 7 screws from the bottom half of the back of appliance illustrated. Remove back plate.
- B. Locate the flame generation cylinder drum. It is constructed of two removable halves. They are two (2) matte black sheet metal pieces with holes in them, either of which can be removed from the appliance.
- C. Remove the screw as illustrated, that is used to secure the flame generation cylinder drum.
- D. Squeeze half of drum cylinder until its top edge clears the top drum track. Remove the bottom edge of the cylinder drum from the bottom drum track. This will give you access to the lamps. **NOTE: Do not exert excessive pressures on the drum cylinder as this may cause damage.**
- E. Remove spring clip. Hold socket and pull out old lamp.
- F. Hold socket and push in new lamp (DO NOT exceed wattage). Replace spring clip.
- G. Repeat steps C and D for the second lamp.
- H. Insert bottom edge of removed cylinder half into bottom drum track. Gently squeeze drum cylinder until its top edge fit into top drum rack. Reattach the screw that was removed in step B.
- I. Secure the back plate of the appliance to the main appliance by reattaching the 7 screws removed from step A.

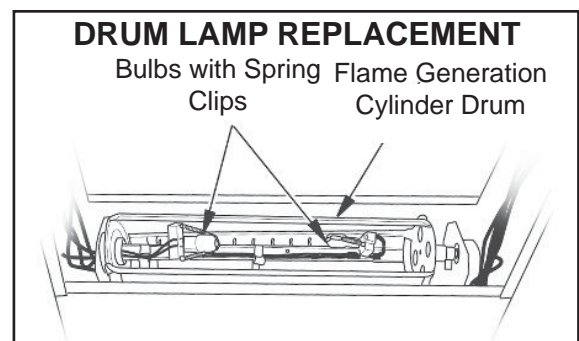
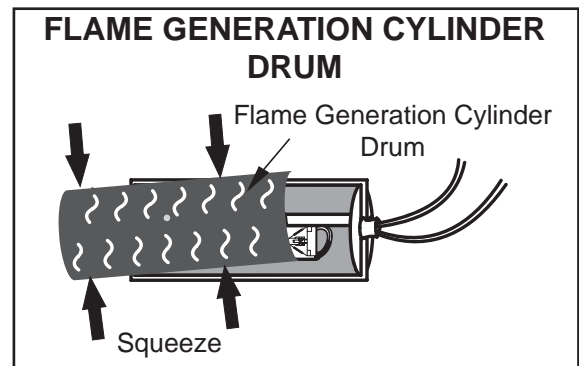
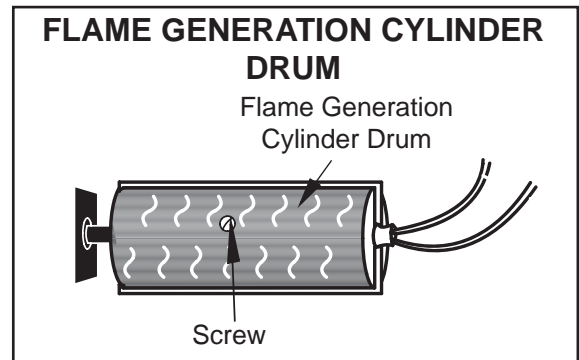
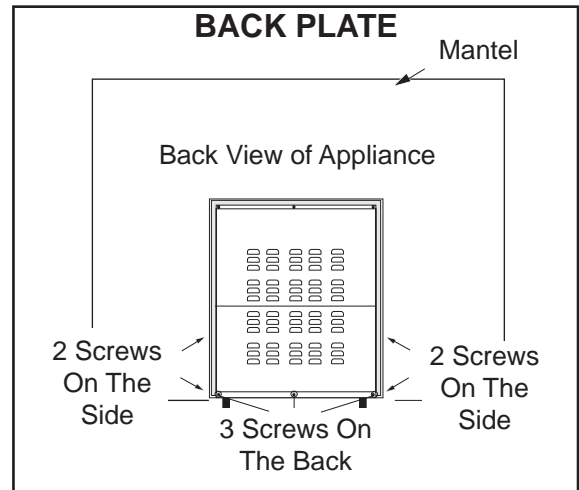

7.2 EMBER BED LAMP REPLACEMENT

- A. Remove the 7 screws from the bottom half of the back of appliance as illustrated. Remove back plate.
- B. Locate the ember bed lamps which are underneath the flame generation cylinder drum.
- C. Remove spring clip. Hold socket and pull out old lamp.
- D. Hold socket and push in new lamp (DO NOT exceed wattage or handle with bare hands).
- E. Repeat steps C and D for the second lamp.
- F. Secure the back plate of the appliance to the main appliance by reattaching the 7 screws removed from step A.

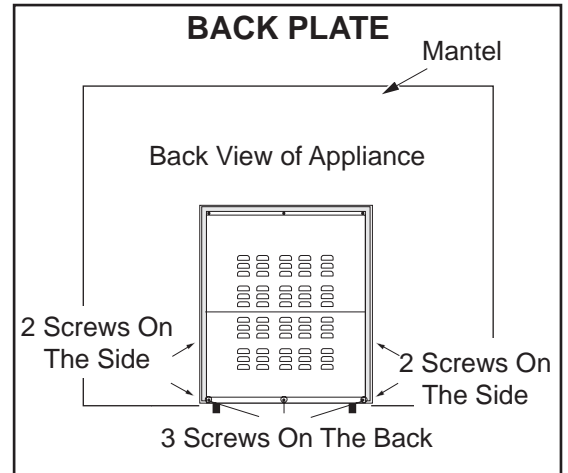

LOCATE THE EMBER BED LAMPS

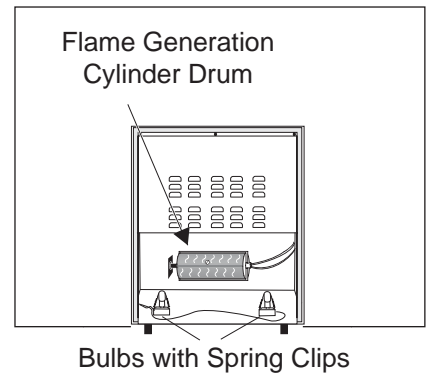

EMBER BED LAMP REPLACEMENT

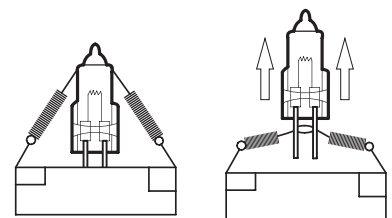

7.3 CARE OF GLASS

DO NOT CLEAN GLASS WHEN HOT! DO NOT USE ABRASIVE CLEANERS TO CLEAN GLASS.

Buff lightly with a clean dry soft cloth. Clean both sides of the glass after the first 10 hours of operation with a recommended fireplace glass cleaner. Thereafter clean as required. If the glass is not kept clean permanent discoloration and / or blemishes may result.



8.0 WIRING DIAGRAM

! WARNING
ENSURE ALL POWER IS TURNED OFF BEFORE HARD WIRING THIS APPLIANCE.

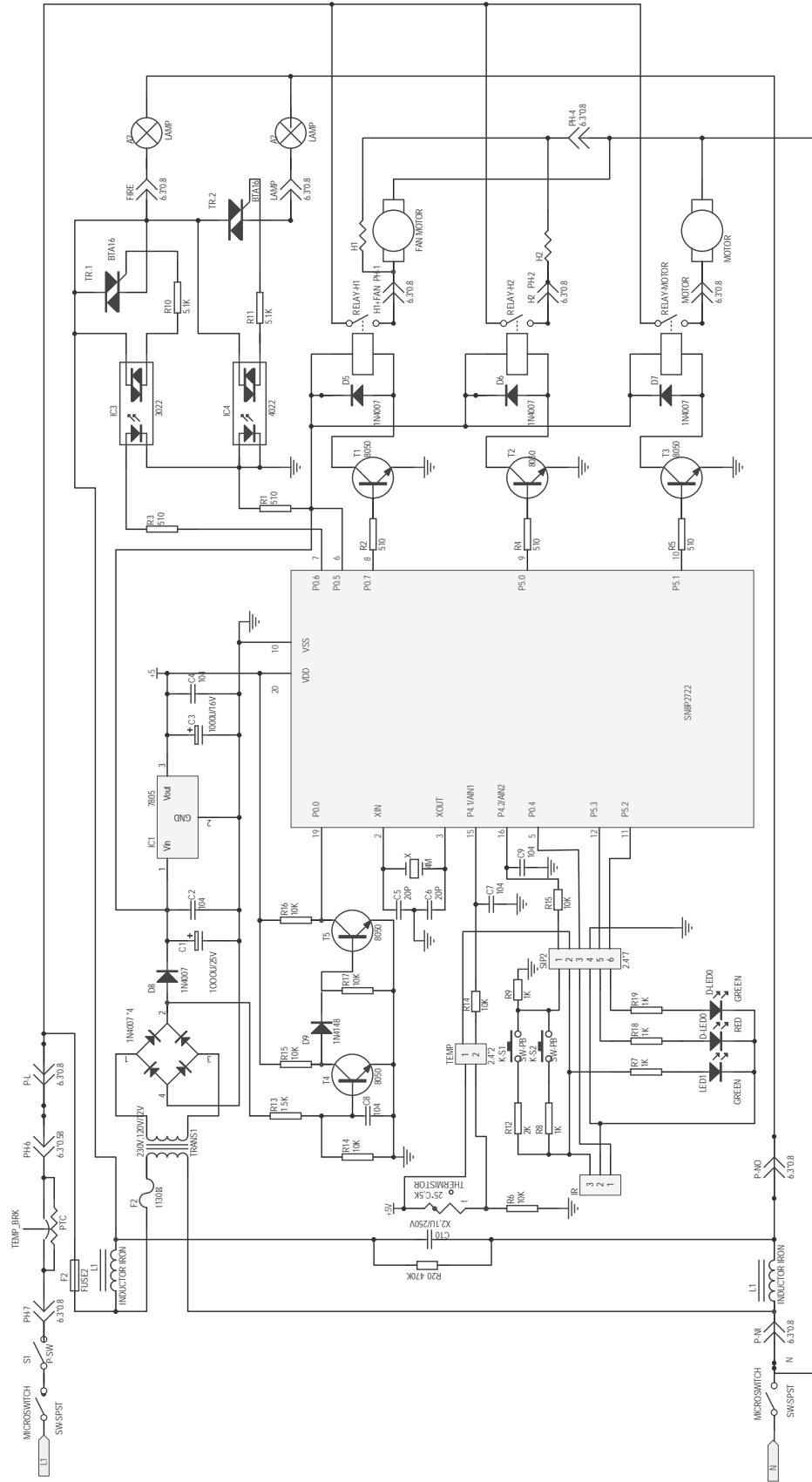

9.0 REPLACEMENT PARTS

Contact your dealer or the factory for questions concerning prices and policies on replacement parts. Normally all parts can be ordered through your Authorized dealer / distributor.

FOR WARRANTY REPLACEMENT PARTS, A PHOTOCOPY OF THE ORIGINAL INVOICE WILL BE REQUIRED TO HONOUR THE CLAIM.

When ordering replacement parts always give the following information:

- Model & Serial Number of appliance
- Installation date of appliance
- Part number
- Description of part
- Finish

*** IDENTIFIES ITEMS WHICH ARE NOT ILLUSTRATED. FOR FURTHER INFORMATION, CONTACT YOUR AUTHORIZED DEALER.**

! WARNING

FAILURE TO POSITION THE PARTS IN ACCORDANCE WITH THIS MANUAL OR FAILURE TO USE ONLY PARTS SPECIFICALLY APPROVED WITH THIS APPLIANCE MAY RESULT IN PROPERTY DAMAGE OR PERSONAL INJURY.

41.1

For aftermarket sales and service please call 1-866-592-6667

COMPONENTS		
REF #	PART #	DESCRIPTION
1	DQ017-002	LAMPS
2	DQ002-006	CIRCUIT BOARD
3	DQ006-003	SWITCH
4	R-19	REMOTE CONTROL
5	Q/T FRT01-000-00B	HEATER (HEATER WITH BLOWER)
6*	W300-0117	REPLACEMENT GLASS EMBERS

ACCESSORIES		
REF #	PART #	DESCRIPTION
1*	W660-0081	DIGITAL THERMOSTAT
2*	W690-0001	MILLIVOLT THERMOSTAT

NOTE: Care must be taken when removing and disposing of any broken glass or damaged components. Be sure to vacuum up any broken glass from inside the appliance before operation.

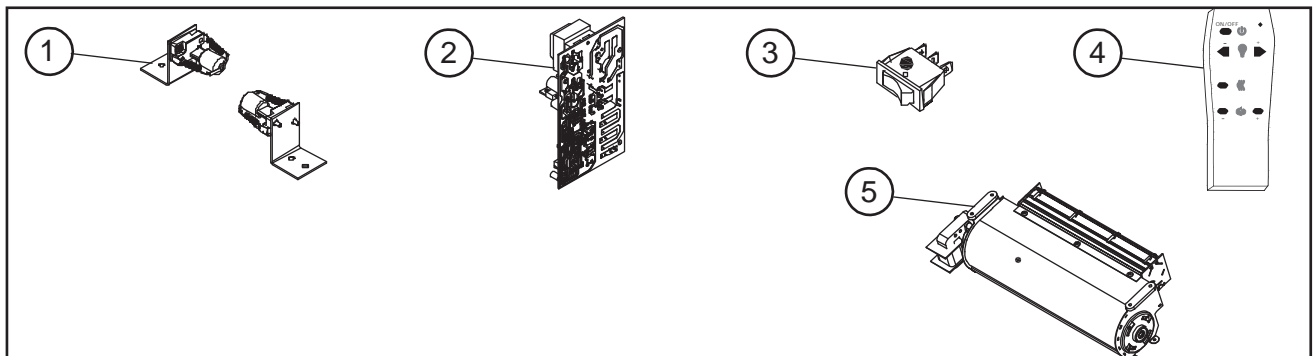

10.0 TROUBLE SHOOTING

! WARNING

TURN OFF THE APPLIANCE COMPLETELY AND LET COOL BEFORE SERVICING. ONLY A QUALIFIED SERVICE PERSON SHOULD SERVICE AND REPAIR THIS ELECTRIC APPLIANCE.

SYMPTOM	PROBLEM	TEST SOLUTION
Dim or no flame	Bulb(s) are burnt out	Inspect the bulbs inside the flame generation cylinder drum and replace them if necessary
Ember bed is not glowing or dimming	Bulb(s) are burnt out	Inspect the ember bed bulbs and replace them if necessary
Appliance turns off and will not turn on	Appliance has overheated and safety device has caused the thermal switch to disconnect	Unplug the appliance, allow appliance to cool for 15 minutes, then plug it back in
	House circuit breaker has tripped	Reset house circuit breaker
Appliance will not come on when switch is flipped to ON	Appliance is not plugged into an electrical outlet	Check plug and plug it in
	Appliance has overheated and safety device has caused the thermal switch to disconnect	Unplug the appliance, allow appliance to cool for 15 minutes, then plug it back in
Remote control does not work	Low batteries	Replace batteries in remote control

42.17

SYMPTOM	PROBLEM	TEST SOLUTION
No warm air is coming out of the appliance	Room temperature is higher than the appliance setting (if it is set to LO or MED)	- Set appliance to a higher temperature setting (MED or HI)
Heater shuts off automatically	Room is too warm	- The heater has a built-in thermostat so it will shut off automatically once the pre-set temperature is reached. It will also turn on automatically if the room temperature drops below the pre-set temperature. Preset temperature is dependent on heater settings selected.

11.0 WARRANTY

NAPOLEON® electric appliances are manufactured under the strict Standard of the world recognized ISO 9001 : 2008 Quality Assurance Certificate.

NAPOLEON® products are designed with superior components and materials, assembled by trained craftsmen who take great pride in their work. Once assembled the complete appliance is thoroughly inspected by a qualified technician before packing to ensure that you , the customer, receive the quality product that you expect from NAPOLEON®.

NAPOLEON® ELECTRIC APPLIANCE LIMITED WARRANTY

Electrical components and wearable parts such as fan/heater, motors, switches, nylon bearing components and remote controls are covered and NAPOLEON® will provide replacement parts free of charge during the first year of limited warranty. Light bulbs and fuses are NOT covered by the warranty.
Any labour related to warranty repair is not covered.
* Construction of models vary. Warranty applies only to components included with your specific appliance.

CONDITIONS AND LIMITATIONS

NAPOLEON® warrants its products against manufacturing defects to the original purchaser only. Registering your warranty is not necessary. Simply provide your proof of purchase along with the model and serial number to make a warranty claim. NAPOLEON® reserves the right to have its representative inspect any product or part thereof prior to honouring any warranty claim. Provided that the purchase was made through an authorized NAPOLEON® dealer your appliance is subject to the following conditions and limitations:
Warranty coverage begins on the date of original installation.
This factory warranty is non-transferable and may not be extended whatsoever by any of our representatives.
Installation must be done in accordance with the installation instructions included with the product and all local and national building and fire codes.
This limited warranty does not cover damages caused by misuse, lack of maintenance, accident, alterations, abuse or neglect and parts installed from other manufacturers will nullify this warranty.
This limited warranty further does not cover any scratches, dents, corrosion or discoloring caused by excessive heat, abrasive and chemical cleaners nor chipping on porcelain enamel parts, mechanical breakage of PHAZER™ logs.
In the first year only, this warranty extends to the repair or replacement of warranted parts which are defective in material or workmanship provided that the product has been operated in accordance with the operation instructions and under normal conditions.
NAPOLEON® will not be responsible for installation, labour or any other expenses related to the reinstallation of a warranted part and such expenses are not covered by this warranty. Notwithstanding any provisions contained in the Limited Warranty, NAPOLEON's responsibility under this warranty is defined as above and it shall not in any event extend to any incidental, consequential or indirect damages.
This warranty defines the obligations and liability of NAPOLEON® with respect to the NAPOLEON® electric appliance and any other warranties expressed or implied with respect to this product, its components or accessories are excluded.
NAPOLEON® neither assumes, nor authorizes any third party to assume, on its behalf, any other liabilities with respect to the sale of this product.
Any damages to appliance, brass trim or other component due to water, weather damage, long periods of dampness, condensation, damaging chemicals or cleaners will not be the responsibility of NAPOLEON®.
The bill of sale or copy will be required together with a serial number and a model number when making any warranty claims from your authorized dealer. The warranty registration card must be returned within fourteen days to register the warranty.
NAPOLEON® reserves the right to have its representative inspect any product or part thereof prior to honouring any warranty claim.
All parts replaced under the Limited Warranty Policy are subject to a single claim.
All parts replaced under the warranty will be covered for a period of 90 days from the date of their installation.
The manufacturer may require that defective parts or products be returned or that digital pictures be provided to support the claim. Returned products are to be shipped prepaid to the manufacturer for investigation. If a product is found to be defective, the manufacturer will repair or replace such defect.
Before shipping your appliance or defective components, your dealer must obtain an authorization number. Any merchandise shipped without authorization will be refused and returned to sender.
Shipping costs are not covered under this warranty.
Additional service fees may apply if you are seeking warranty service from a dealer.

ALL SPECIFICATIONS AND DESIGNS ARE SUBJECT TO CHANGE WITHOUT PRIOR NOTICE DUE TO ON-GOING PRODUCT IMPROVEMENTS.
NAPOLEON® IS A REGISTERED TRADEMARK OF WOLF STEEL LTD.

2.5B

12.0 SERVICE HISTORY

Appliance Service History This heater must be serviced annually depending on usage.				
Date	Dealer Name	Service Technician Name	Service Performed	Special Concerns