

CORR/GUARD® *SPECIAL GAS VENT*

Components specifically for

Direct Vent Tankless Water Heaters

**SUPERIOR DESIGN AND CONSTRUCTION
AND ORDERS SHIPPED FAST, 100% COMPLETE!**



- **All-Metal Construction**
Can be used for fire-rated applications
- **Standard Vent Discharge Kit**
Vent pipe added as needed
- **Variable Length**
No sawing or cutting needed on job site
- **Thoroughly tested by CSA**
Operates properly at sub-freezing temperatures
- **UL Listed to 1738**
- **Labeled Product**
Customers know what they're installing
What inspectors want to see - avoid calls on unlabeled product
- **Positive Stop Lock Joints**
Won't come apart
No taping at joints
- **Integral Flue & Casing**
No need to support every joint - only at seven foot intervals
- **Listed to 10" water column positive pressure**
- **AL29-4C Stainless Steel Flue**
Won't corrode
No aluminum deterioration and leaks

METAL-FAB INC.

Rinnai
R85

CORR/GUARD SPECIAL GAS VENT

STRAIGHT LENGTH - 3CG

Part#	I.D.	A
3CG6	3.00	5.66
3CG12	3.00	11.66
3CG18	3.00	17.66
3CG24	3.00	23.66
3CG36	3.00	35.66

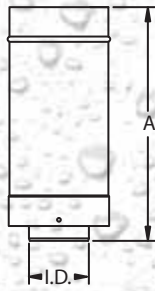

ADJUSTABLE VENT PIPE - 3CGAL

I.D.	A
3.00	19.00 to 35.00

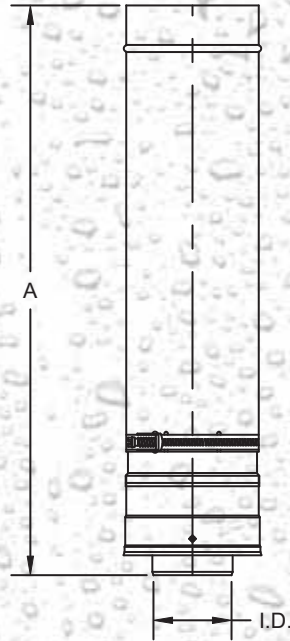

MALE TO MALE ADAPTER - 3CGDMA

I.D.	A
3.00	5.00

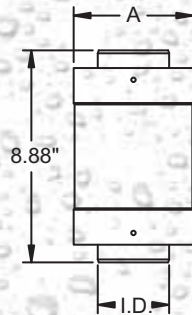

FEMALE TO FEMALE ADAPTER - 3CGDFA

I.D.	A
3.00	5.00

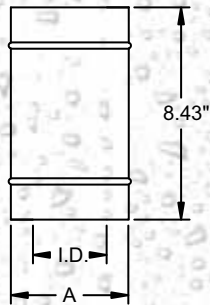

90° ELBOW - 3CG90L

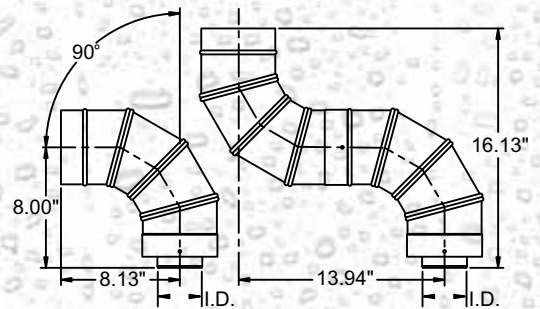

I.D.
3.00

RINNAI HORIZONTAL ADAPTER - 3CGRHA

I.D.	O.D.
3.00	5.00

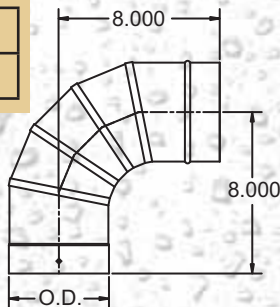

STANDARD VENT DISCHARGE KIT - 3CGRVDK

(Not shown)
Includes 3CGRHA & 3CGRHT*
*Vent pipe added as needed

CORR/GUARD SPECIAL GAS VENT

45° ELBOW - 3CG45L

I.D.
3.00

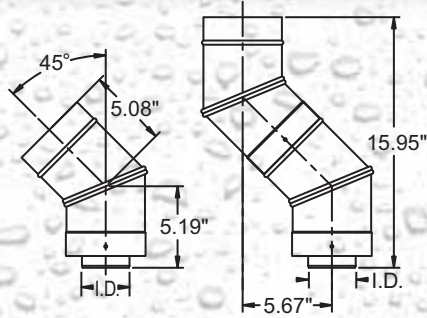

VERTICAL DRAIN SECTION - 3CGVDS

I.D.
3.00

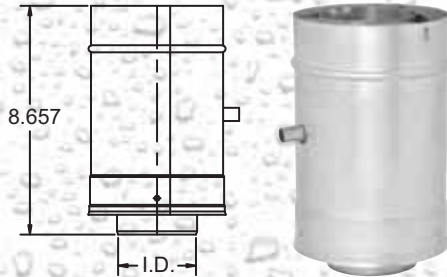

HORIZONTAL DRAIN SECTION - 3CGDS

I.D.
3.00

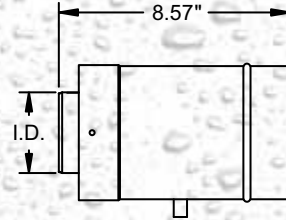

HORIZONTAL TERMINATION - 3CGRHT

I.D.
3.00

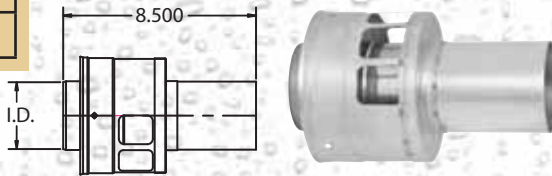

VERTICAL TERMINATION - 3CGRVT

I.D.
3.00

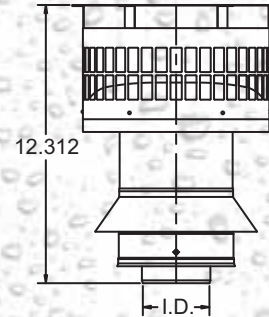

WALL HANGER - 3CGWH

O.D.	A	B
5.00	6.10	3.50

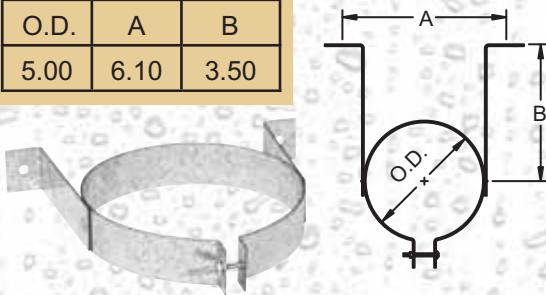

STORM COLLAR - 3CGSC

I.D.
5.00

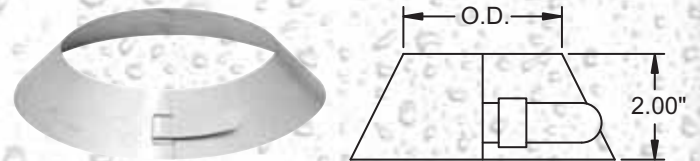

RINNAI VERTICAL ADAPTER - 3CGRIA

A	I.D.
5.06	3.00

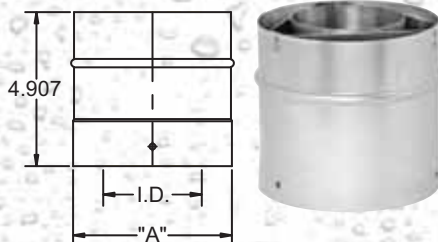

ROOF FLASHING ASSY

0/12 TO 1/12 3CGFT
 2/12 TO 5/12 3CGF
 6/12 TO 12/12 3CGF-12

A	B
3.50	14.63
3.50	14.63
3.50	20.00

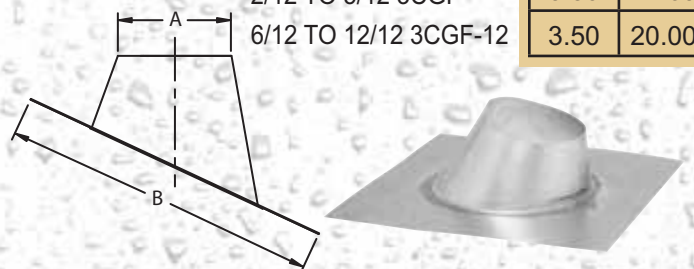

Typical Direct Vent Installations

ROOF EXHAUST

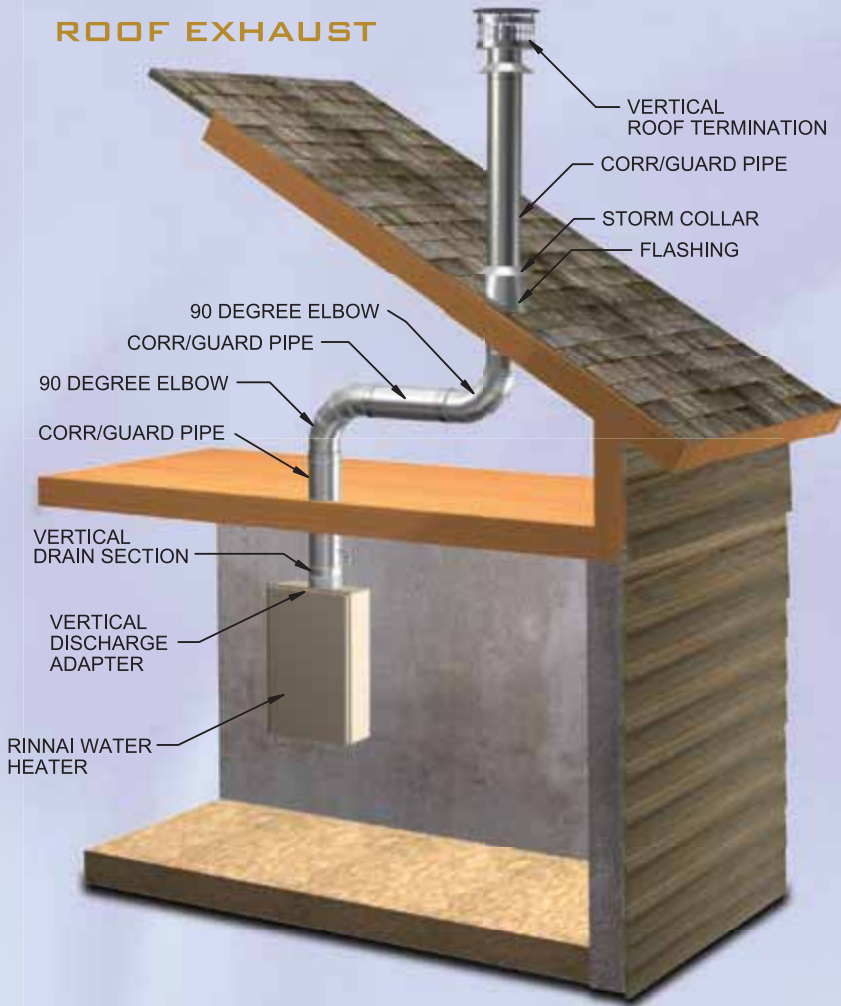

SIDEWALL EXHAUST

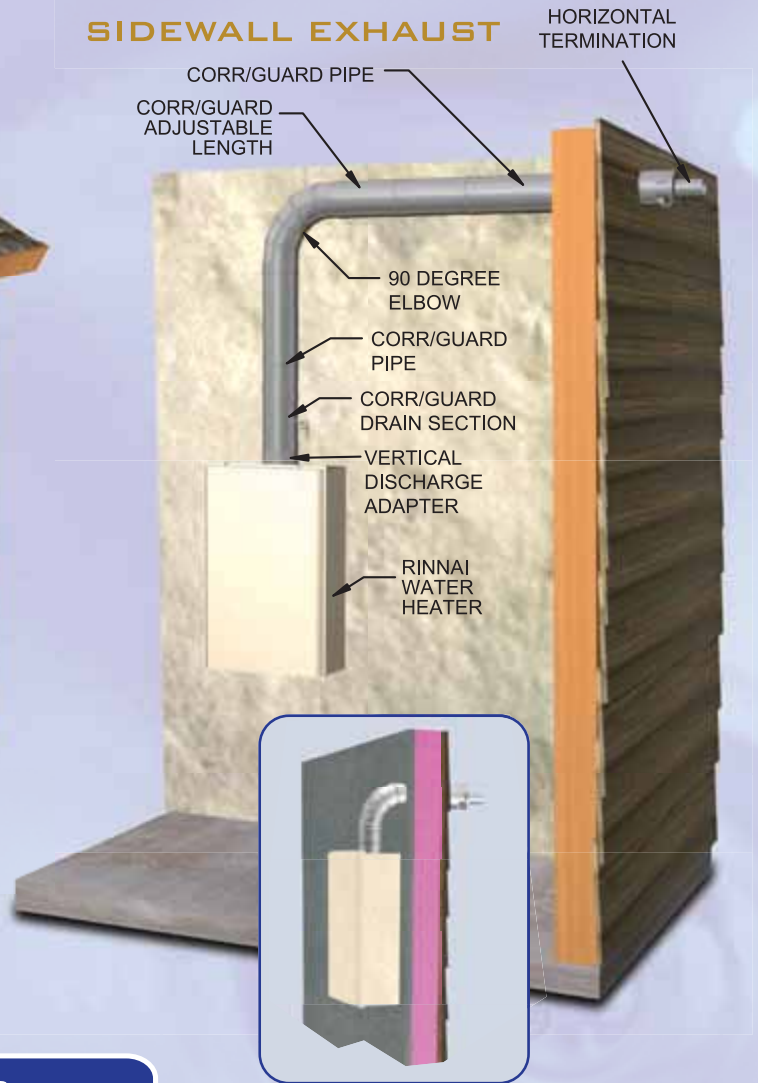

A Full-Line of Vent and Chimney Products.

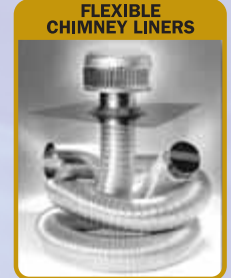
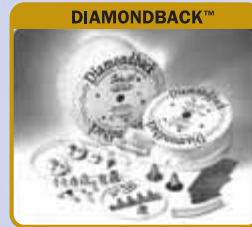
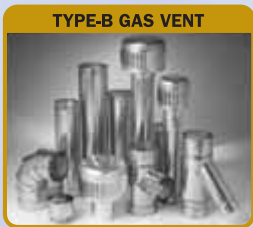

800-835-2830

