

METAL-FAB^{INC.}



BIGVENTTM

TYPE-B GAS VENT IN 14" THROUGH 30" DIAMETERS



What is BigVent™?

Metal-Fab BigVent is Type-B Gas Vent in 14" through 30" diameters. BigVent is factory-built, double-wall, atmospheric vent approved for Category I appliances burning natural or LP gas.

Where is it used?

It is typically used on light commercial, multi-family, loft conversions, strip centers, factories, schools, jails or other installations requiring vent diameters larger than those found in single-family houses.

BigVent is used on both new construction and rehab projects.

Is it Easy to Spec?

In addition to the quality we've built into BigVent, we offer many value-added benefits that make it extremely easy to specify.

- Complete line of components up to 30" diameter.
- Factory sizing assistance that takes the guesswork out of ordering. Just send us the plans for your project and we'll provide sizing at no charge.
- All products furnished conform to the requirements of the National Fuel Gas Code, NFPA-54.
- All products are listed to UL-441 and carry the appropriate UL mark or label.
- Warranted against defects in material or workmanship for a period of one (1) year.

Is it Easy to Order?

- Recognizing that you need product fast for your project, our large factory inventory allows us to ship within 1-3 working days of your order.
- Your order will arrive 100% complete.
- Drop shipping to the project site is available.

GET THE BIG JOBS WITH METAL-FAB BIGVENT™!

BIGVENT TYPE - B GAS VENT

Note: Vent overlaps 1.5" when joined together. Therefore, assembled length is 1.5" less than listed length.

PIPE LENGTHS - 14M through 30M

With positive twist lock on 14".

With quick connect lock using sheet metal screws on 16" - 30".

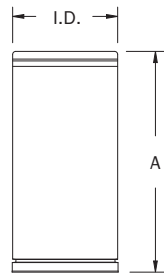

| DIAMETER | 12" | 18" | 24" | 36" |
|------------|-----|-----|-----|-----|
| 14" to 30" | X | X | X | X |

I.D. = 14" through 30" diameter.
A = Length. See chart for available lengths.

**ADJUSTABLE LENGTHS
M12A - M18A**

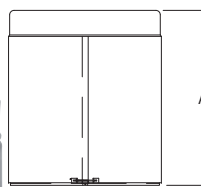

With positive twist lock on 14".

With quick connect lock using sheet metal screws on 16" - 30".

**45° 2-PIECE ELBOW - M45 - 14", 16"
45° 3-PIECE ELBOW - M45 - 18" through 30"**

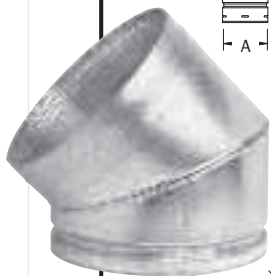
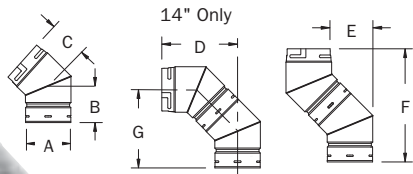

← Fixed 45° 2-piece elbow shown.

16" Through 30"

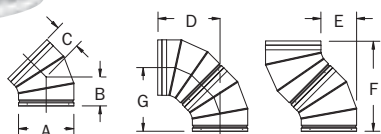

| CAT. NO. | SIZE | A | B | C | D | E | F | G |
|----------|------|---------|---------|---------|--------|--------|--------|--------|
| 14M45 | 14" | 15.000" | 8.250" | 7.250" | 17.25" | 10.00" | 25.38" | 18.15" |
| 16M45 | 16" | 17.000" | 7.000" | 9.000" | 19.43" | 10.43" | 26.43" | 17.25" |
| 18M45 | 18" | 19.125" | 10.790" | 10.790" | 24.99" | 14.20" | 35.78" | 24.99" |
| 20M45 | 20" | 21.125" | 10.790" | 10.790" | 24.99" | 14.20" | 35.78" | 24.99" |
| 22M45 | 22" | 23.125" | 10.790" | 10.790" | 24.99" | 14.20" | 35.78" | 24.99" |
| 24M45 | 24" | 25.125" | 10.790" | 10.790" | 24.99" | 14.20" | 35.78" | 24.99" |
| 26M45 | 26" | 27.125" | 11.950" | 11.950" | 27.78" | 15.84" | 39.72" | 27.78" |
| 28M45 | 28" | 29.125" | 11.950" | 11.950" | 27.78" | 15.84" | 39.72" | 27.78" |
| 30M45 | 30" | 31.125" | 11.950" | 11.950" | 27.78" | 15.84" | 39.72" | 27.78" |

Note: 14" elbows are adjustable, and have positive twist lock. Fixed angles in 16" through 30" diameter have quick connect lock using sheet metal screws.

BIGVENT TYPE - B GAS VENT

STANDARD TEE – MT - 14" through 30"

*Tap centered on installed body length

| CAT. NO. | SIZE | A | B | C |
|----------|------|---------|--------|----|
| 14MT | 14" | 15.000" | 23.00" | 4" |
| 16MT | 16" | 17.125" | 28.50" | 4" |
| 18MT | 18" | 19.125" | 30.50" | 4" |
| 20MT | 20" | 21.125" | 32.50" | 4" |
| 22MT | 22" | 23.125" | 34.50" | 4" |
| 24MT | 24" | 25.125" | 36.50" | 4" |
| 26MT | 26" | 27.125" | 38.50" | 4" |
| 28MT | 28" | 29.125" | 40.50" | 4" |
| 30MT | 30" | 31.125" | 42.50" | 4" |

Tees in 14" diameter have positive twist lock.
 Tees in 16" through 30" diameter use quick connect lock using sheet metal screws.

VENT CAP – MC - 14" through 30"

| CAT. NO. | SIZE | A | B | C | D |
|----------|------|-----|--------|--------|-------|
| 14MC | 14" | 15" | 23.25" | 28.62" | 5.62" |
| 16MC | 16" | 17" | 22.50" | 30.62" | 7.00" |
| 18MC | 18" | 19" | 24.50" | 32.87" | 7.00" |
| 20MC | 20" | 21" | 29.00" | 39.00" | 5.75" |
| 22MC | 22" | 23" | 29.50" | 41.50" | 8.00" |
| 24MC | 24" | 25" | 31.50" | 43.50" | 8.00" |
| 26MC | 26" | 27" | 35.50" | 50.25" | 6.00" |
| 28MC | 28" | 29" | 36.50" | 52.25" | 7.50" |
| 30MC | 30" | 31" | 37.00" | 54.25" | 7.50" |

Note: 14" has positive twist lock.
 16" - 30" has quick connect lock.

INCREASERS – Mix

14" Only

16" through 30"

| CAT. NO. | 14"-30" | | |
|----------|-----------|-------|------|
| | A | B | C |
| ?Mix14 | Specified | x 14" | 8.5" |
| ?Mix16 | Specified | x 16" | 8.5" |
| ?Mix18 | Specified | x 18" | 8.5" |
| ?Mix20 | Specified | x 20" | 8.5" |
| ?Mix22 | Specified | x 22" | 8.5" |
| ?Mix24 | Specified | x 24" | 8.5" |
| ?Mix26 | Specified | x 26" | 8.5" |
| ?Mix28 | Specified | x 28" | 8.5" |
| ?Mix30 | Specified | x 30" | 8.5" |

BIGVENT TYPE - B GAS VENT

DRAFTHOOD CONNECTOR – MDC

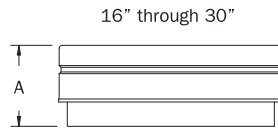
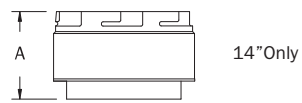

| CAT. NO. | SIZE | A |
|----------|------|--------|
| 14MDC | 14" | 4.875" |
| 16MDC | 16" | 5.000" |
| 18MDC | 18" | 5.000" |
| 20MDC | 20" | 5.000" |
| 22MDC | 22" | 5.000" |
| 24MDC | 24" | 5.000" |
| 26MDC | 26" | 5.000" |
| 28MDC | 28" | 5.000" |
| 30MDC | 30" | 5.000" |

SUPPORT PLATE – MSP

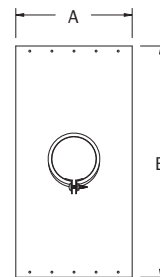

| CAT. NO. | SIZE | A | B |
|----------|------|-------|-------|
| 14MSP | 14" | 19.5" | 21.5" |
| 16MSP | 16" | 21.5" | 21.5" |
| 18MSP | 18" | 23.5" | 24.0" |
| 20MSP | 20" | 25.5" | 30.0" |
| 22MSP | 22" | 27.5" | 30.0" |
| 24MSP | 24" | 29.5" | 30.0" |
| 26MSP | 26" | 31.5" | 36.0" |
| 28MSP | 28" | 33.5" | 36.0" |
| 30MSP | 30" | 35.0" | 36.0" |

HEAVY SUPPORT – MHS - 14" through 30"

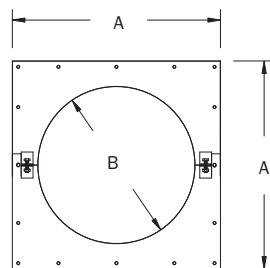
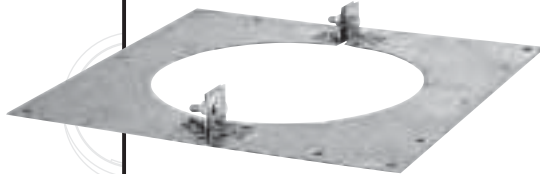

| CAT. NO. | SIZE | A | B |
|----------|------|-----|---------|
| 14MHS | 14" | 20" | 14.625" |
| 16MHS | 16" | 22" | 16.625" |
| 18MHS | 18" | 24" | 18.625" |
| 20MHS | 20" | 26" | 20.625" |
| 22MHS | 22" | 28" | 22.625" |
| 24MHS | 24" | 30" | 24.625" |
| 26MHS | 26" | 32" | 26.625" |
| 28MHS | 28" | 34" | 28.625" |
| 30MHS | 30" | 36" | 30.625" |

Designed to support large size pipe sections.
Also serves as a firestop.

BIGVENT TYPE - B GAS VENT

GUY RING – MGR

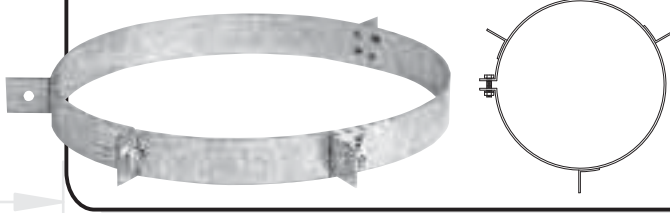

Sizes 14" through 30"
For additional support above the roof.

STANDARD FLASHING – MF

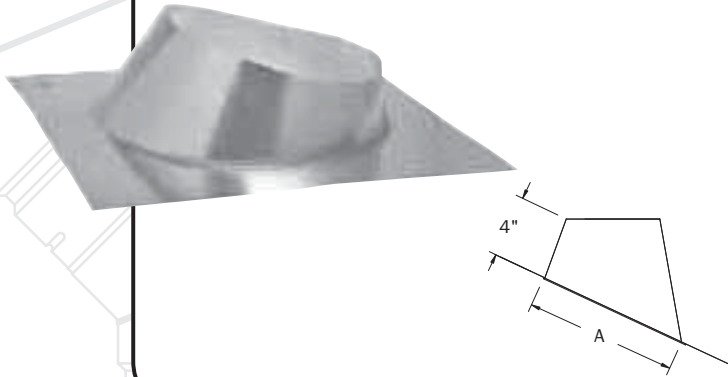

| CAT. NO. | SIZE | A | PLATE |
|----------|------|---------|-------------------|
| 14MF | 14" | 18.750" | 26.750" x 26.750" |
| 16MF | 16" | 21.000" | 29" x 29" |
| 18MF | 18" | 22.750" | 32" x 32" |
| 20MF | 20" | 27.000" | 33" x 33" |
| 22MF | 22" | 26.750" | 35" x 35" |
| 24MF | 24" | 29.250" | 38" x 38" |
| 26MF | 26" | 31.750" | 40" x 40" |
| 28MF | 28" | 32.750" | 42" x 42" |
| 30MF | 30" | 36.250" | 45" x 45" |

Fits roof pitch from 2/12 to 5/12.

TALL CONE FLAT FLASHING – MFT

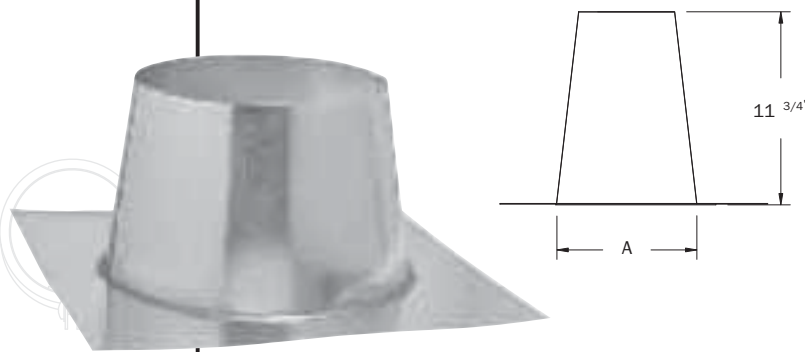

| CAT. NO. | SIZE | A | PLATE |
|----------|------|---------|-------------------|
| 14MFT | 14" | 19.00" | 26.750" x 26.750" |
| 16MFT | 16" | 21.312" | 29" x 29" |
| 18MFT | 18" | 22.562" | 32" x 32" |
| 20MFT | 20" | 24.750" | 33" x 33" |
| 22MFT | 22" | 26.750" | 35" x 35" |
| 24MFT | 24" | 28.750" | 38" x 38" |
| 26MFT | 26" | 30.750" | 40" x 40" |
| 28MFT | 28" | 33.875" | 42" x 42" |
| 30MFT | 30" | 34.750" | 45" x 45" |

Flat roof flashing.

BIGVENT TYPE - B GAS VENT

TEE CAP – MTC



Sizes 14" through 30".
Use to cap flue when tee has no bottom (inlet) entry.

STORM COLLAR – MSC

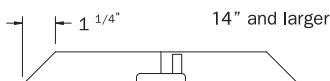

| CAT. NO. | SIZE |
|----------|------|
| 14MSC | 14" |
| 16MSC | 16" |
| 18MSC | 18" |
| 20MSC | 20" |
| 22MSC | 22" |
| 24MSC | 24" |
| 26MSC | 26" |
| 28MSC | 28" |
| 30MSC | 30" |

FOR YOUR REFERENCE



Listed 441

MODEL "M" TYPE B, GAS VENT

METAL-FAB ROUND TYPE-B GAS VENT IS LISTED BY UNDERWRITERS LABORATORIES, INC. FOR USE WITH APPROVED GAS FURNACES, HEATERS AND BOILERS. METAL-FAB MEETS OR EXCEEDS ALL RECOGNIZED GAS VENTING CODES, STANDARDS OR REQUIREMENTS, WHETHER LOCAL, STATE OR U.S. MAXIMUM TEMPERATURE RATING FOR B-VENT IS 530° F.

- 1" Minimum clearance to combustibles for 14" through 24" diameters.
- 2" Minimum clearance to combustibles for 26" through 30" diameters.

A FULL LINE OF QUALITY PRODUCTS

TYPE-B GAS VENT



Easiest installation on the market...featuring SureLock™ B-Vent Locking System.

HEARTH PRODUCTS



Complete line of Solid Fuel Chimney, Pellet Chimney and Black Pipe.

CORR/GUARD™



Designed for corrosive appliances and exhaust systems.

FLEXIBLE CHIMNEY LINERS



Available in complete relining kits.

DAMPERS



Complete line of fire and ceiling radiation dampers. Capacity to fill high volume orders 100%.

DIAMONDBACK™



Flexible Gas Piping - Faster installations of gas pipe for new construction or retrofit projects.

METAL-FAB[®] INC.

P.O. BOX 1138 • WICHITA, KANSAS 67201

(316) 943-2351 • FAX (316) 943-2717

e-mail: info@metal-fabinc.com • www.metal-fabinc.com

800-835-2830