

Wood-Burning Fireplaces

BEAUTY BY DESIGN

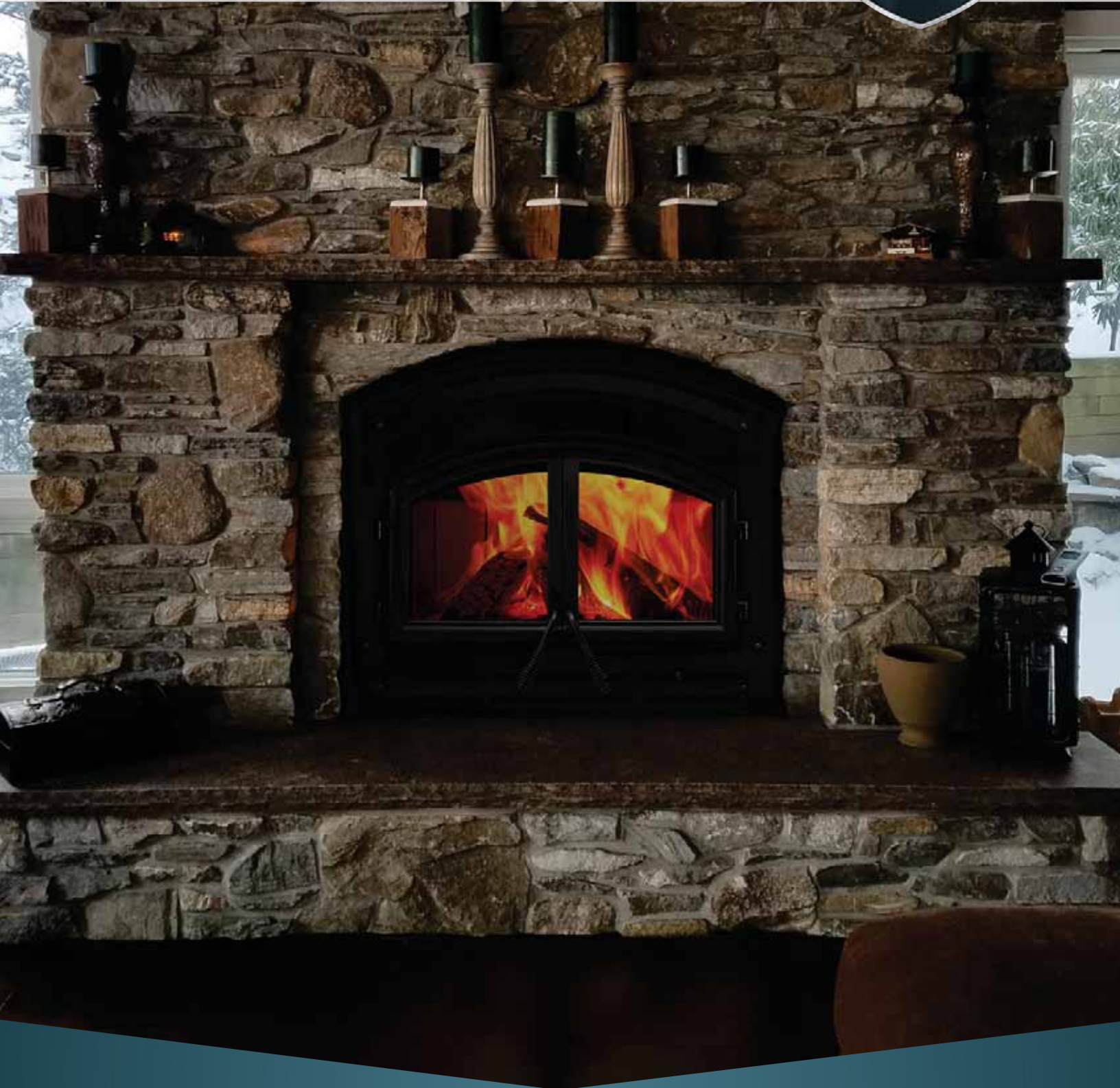

Pioneer III

EPA Wood-Burning Fireplace

This EPA-approved wood-burning fireplace combines efficiency with rolling flames seen through the cast-iron framed glass door. Smart Burn Technology makes it easy to control the fire, enabling you to push a button, and walk away. This whole-house heater is available with rectangular and arched doors with three front choices.



Pioneer III Quick Look

- Smart Burn Technology – controls the air coming into your fire
- Heats 1,200-3,000 sq.ft. with up to 85,175 BTUs based on climate and home efficiency
- 4.1 cu. ft. firebox holds 24" logs for long-lasting heat
- 2 door styles with 3 front options
- 400-CFM fan system pushes heat further and faster into your room
- Certified to the EPA 2020 emissions standard

Pioneer III shown with Mission Arch Front.

Pioneer III Front Options (required to complete)



Forged Arch front



Mission Arch front



Mission Rectangular front

Pioneer II

EPA Wood-Burning Fireplace



Enjoy hassle-free performance that's ideal for everyday use. The efficiency of the EPA- approved Pioneer II supplies long burn times with nonstop rolling flames. Never has it been easier to set the mood for relaxing or just keeping your home or cabin toasty warm.

Pioneer II Quick Look

- Heats 1,000-2,600 sq. ft. with 68,200 BTUs, based on climate and home efficiency
- 22" recommended log length and 2.7 cu. ft. firebox capacity
- Up to 10 hours of burn time from each load of wood
- Comes standard with front black arched door
- Certified to the EPA 2020 emissions standards

Pioneer II shown with single cast iron door and firebrick interior.

WarmMajic II

EPA Wood-Burning Fireplace



Enhance your home's heating profile with a clean-burning, efficient wood fireplace you can depend on. This eco-friendly wood fireplace exceeds the strictest environmental standards. Come home to the comfort of the WarmMajic II and enjoy big heat and bold flames.

WarmMajic II Quick Look

- Eco-friendly EPA certified
- High performance dual fans with adjustable speed controls distribute a constant flow of heat
- Heat management solutions to heat your whole home
- 68,200 BTUs—heats 1,000 to 2,600 sq. ft. depending on climate and home efficiency
- 22" recommended log length and 2.7 cu. ft. interior capacity
- Modern technology makes starting your fire easier and enables up to 10 hours of burn time

WarmMajic II shown with standard cast-iron doors and firebrick interior.

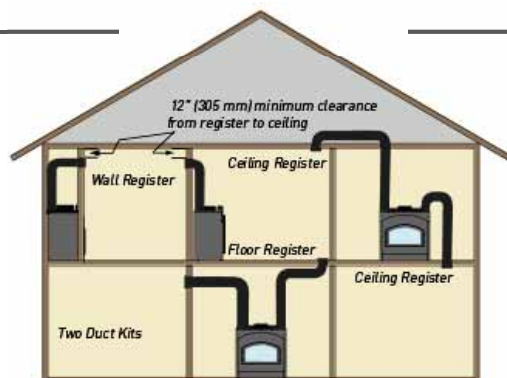

Optional: Heat-Zone duct runs

Heat Management – Optional Heat-Zone Kit (Available on Pioneer III, Pioneer II and Warm Majic II)

With zone heating, you can easily reduce your energy consumption by up to 40%, and reduce your utility bill in the process. Using a Majestic fireplace as a supplemental heating source, you can turn down your central furnace or boiler system and still maintain comfortable temperatures in your common living area.

Ashland

Wood-Burning Fireplace

The Ashland delivers on every level. Customize the design with three available sizes and stylish finishing options. The large firebox gives you a front row seat for unforgettable fires, while the proven history of performance provides peace of mind for many years to come.*

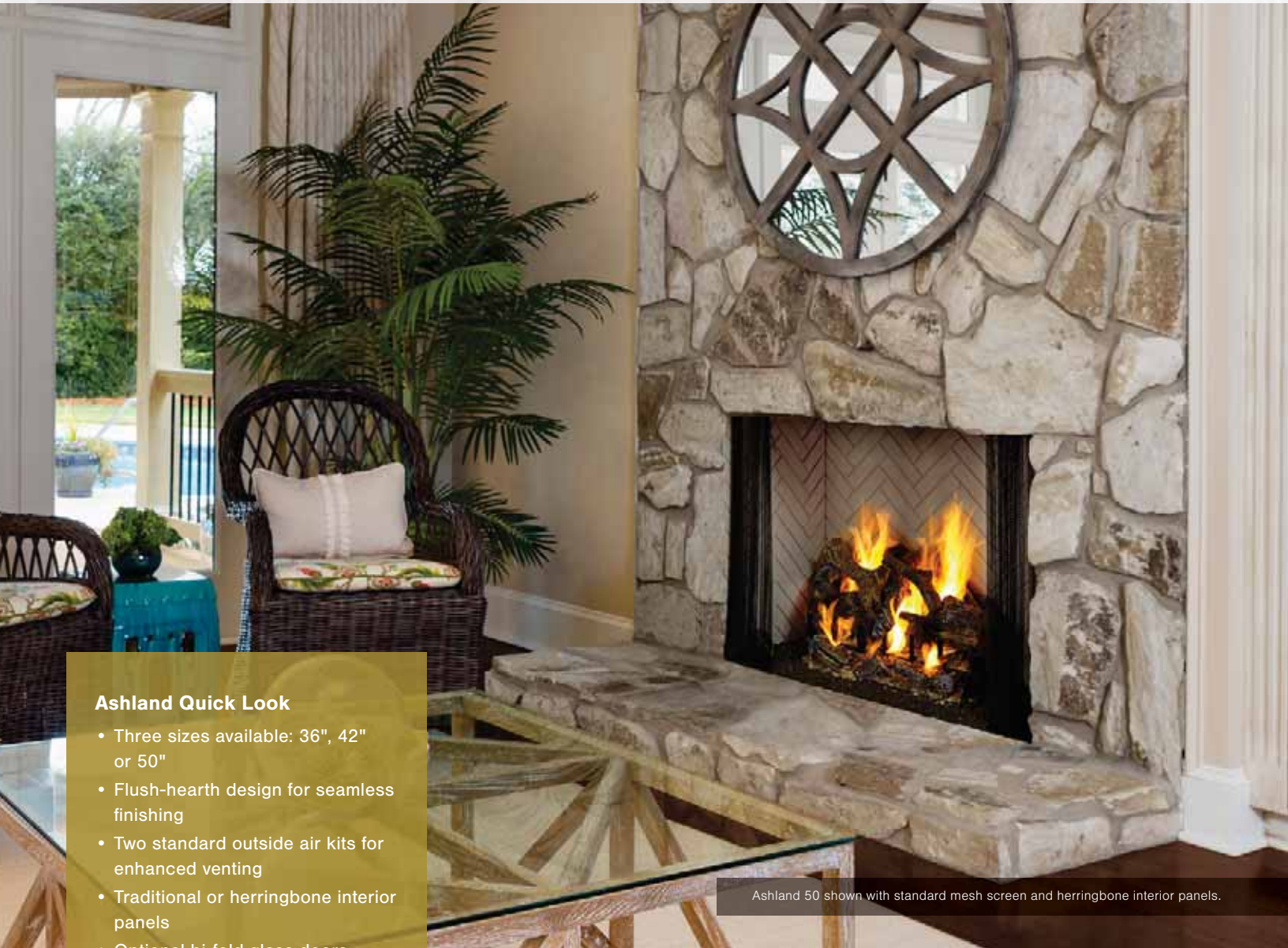

Ashland 50 shown with standard mesh screen and herringbone interior panels.

Ashland Quick Look

- Three sizes available: 36", 42" or 50"
- Flush-hearth design for seamless finishing
- Two standard outside air Kits for enhanced venting
- Traditional or herringbone interior panels
- Optional bi-fold glass doors
- Variety of gas logs available

Interior Panels



Traditional Brick



Herringbone Brick

Door Style



Bi-fold Glass Doors

Door Finish

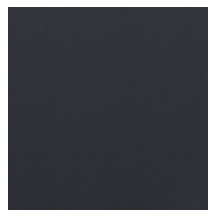

Black



Ashland 50 shown with standard mesh screen and herringbone interior panels.

Biltmore

Wood-Burning Fireplace



The Biltmore includes an expansive viewing area, classic masonry style and clean face design making it the natural focal point of any room, and the perfect place to relax.*

Biltmore Quick Look

- Three sizes available: 36", 42" or 50"
- Clean face design enables finishing materials to be applied up to firebox opening
- Can be installed flush with floor or on a raised hearth
- Variety of gas logs available

Interior Panels



Traditional Brick

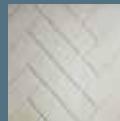

Herringbone Brick

Door Styles



Grand Vista Mesh Doors



Bi-fold Glass Doors

Door Finish

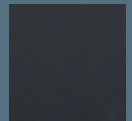

Black

Sovereign

Wood-Burning Fireplace



Some things never go out of style, like the beauty and craftsmanship of a Sovereign wood-burning fireplace. Authentic masonry design and attractive finishing options allow you to create a masterpiece with long-lasting value.

Sovereign Quick Look

- Two sizes available: 36" or 42"
- Radiant or heat-circulating options
- Variety of gas logs available

Interior Panels



Traditional Brick

Door Styles



Grand Vista Mesh Doors



Gasketed Glass Doors



Bi-fold Glass Doors

Door Finishes

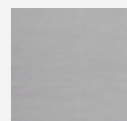

Stainless Steel
(Bi-Fold Glass Doors only)

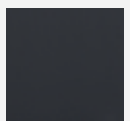

Black

Royalton

Wood-Burning Fireplace



The Royalton has earned a strong reputation for classic style, superior performance and outstanding features. The detailed brick interior with traditional masonry look, up to 42" viewing area and available glass doors make this fireplace a stunning addition to your home's décor.

Royalton Quick Look

- Two sizes available: 36" or 42"
- Convenient ash lip
- Front damper handle locks in open/closed positions
- Variety of gas logs available

Interior Panels



Traditional Brick

Door Style



Bi-fold Glass Doors

Door Finishes



Stainless Steel

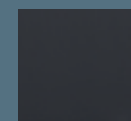

Black

Designer See-Through Wood-Burning Fireplace



Now you can enjoy the incomparable warmth and beauty of your wood-burning fireplace from two rooms at once. Get twice the ambiance with a Designer see-through fireplace.

Designer See-Through Quick Look

- Available in 42"
- Authentic masonry appearance
- Clean face design
- Outside air kit for enhanced venting
- Variety of gas logs available

Interior Panels



Traditional Brick

Door Styles

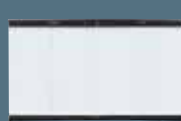

Bi-fold Glass Doors

Door Finish

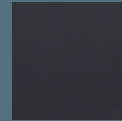

Black

TECHNICAL SPECIFICATIONS

Pioneer III

MODEL	FRONT WIDTH		BACK WIDTH		HEIGHT		DEPTH		FIREPLACE OPENING
	ACTUAL	FRAMING	ACTUAL	FRAMING	ACTUAL	FRAMING	ACTUAL	FRAMING	
PIONEER III	47-7/8" (1194mm)	51" (1295mm)	47-7/8" (1194mm)	51" (1295mm)	47-1/4" (1200mm)	51" (1295mm)	23-1/2" (597mm)	24-1/2" (622mm)	34" x 34" (864mm x 864mm)

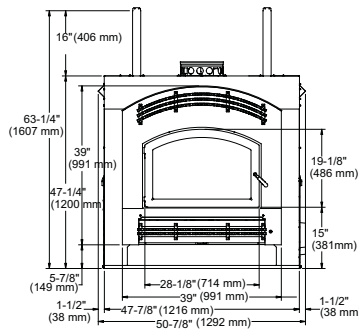

Front View

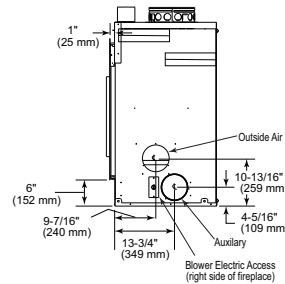

Side View

Pioneer II/WarmMajic II

MODEL	FRONT WIDTH (A)		HEIGHT (B)		DEPTH (C)		REAR WIDTH (D)		FIREPLACE OPENING
	ACTUAL	FRAMING	ACTUAL	FRAMING	ACTUAL	FRAMING	ACTUAL	FRAMING	
Pioneer II WarmMajic II	40" (1016mm)	42-1/2" (1067mm)	40-1/2" (1029mm)	56-3/4" (1441mm)	23-1/2" (597mm)	24** (610mm)	40" (1016mm)	42-1/2" (1067mm)	37" x 31-1/8" (940mm x 791mm)

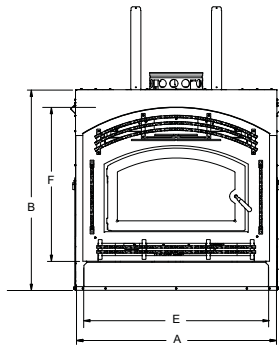

Front View

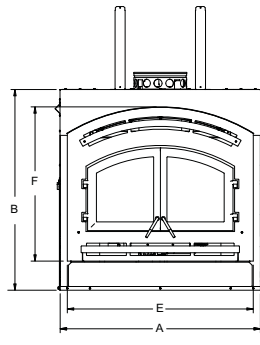

Front View

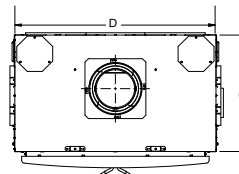

Top View

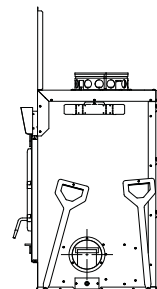

Side View

*If interior of chase will be drywalled, add the thickness to this measurement.

TECHNICAL SPECIFICATIONS

Ashland

MODEL	FRONT WIDTH (A)		HEIGHT (B)		DEPTH (C)		REAR WIDTH (D)		FIREPLACE OPENING (E X F)
	ACTUAL	FRAMING	ACTUAL	FRAMING	ACTUAL	FRAMING	ACTUAL	FRAMING	
ASH36	46-7/8" (1191mm)	47-7/8" (1194mm)	74-1/8" (1883mm)	74-1/2" (1892mm)	27-1/2" (699mm)	28-1/2" (724mm)	31-1/8" (787mm)	47-7/8" (1194mm)	36" x 38" (914mm x 965mm)
ASH42	52-7/8" (1343mm)	53-7/8" (1368mm)	74-1/8" (1883mm)	74-1/2" (1892mm)	27-1/2" (699mm)	28-1/2" (724mm)	37-1/8" (943mm)	53-7/8" (1368mm)	42" x 38" (1067mm x 965mm)
ASH50	60-7/8" (1524mm)	61-7/8" (1549mm)	74-1/8" (1883mm)	74-1/2" (1892mm)	27-1/2" (699mm)	28-1/2" (724mm)	45-1/8" (1147mm)	61-7/8" (1549mm)	50" x 38" (1270mm x 965mm)

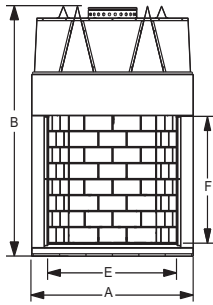

Front View

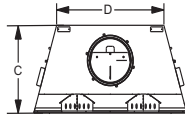

Top View

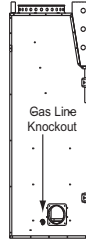

Left Side View



Right Side View

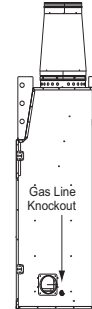

42" Right Side View

Biltmore

MODEL	FRONT WIDTH (A)		HEIGHT (B)		DEPTH (C)		REAR WIDTH (D)		FIREPLACE OPENING (E X F)
	ACTUAL	FRAMING	ACTUAL	FRAMING	ACTUAL	FRAMING	ACTUAL	FRAMING	
SB60	44-1/2" (1130mm)	45-1/2" (1158mm)	59-1/4" (1505mm)	59-3/4" (1518mm)	27-1/2" (699mm)	28" (711mm)	28-5/8" (727mm)	45-1/2" (1158mm)	36" x 28-1/2" (914mm x 724mm)
SB80	50-1/2" (1283mm)	51-1/2" (1301mm)	59-1/4" (1505mm)	59-3/4" (1518mm)	27-1/2" (699mm)	28-1/2" (724mm)	34-1/2" (876mm)	51-1/2" (1308mm)	42 x 28-1/2" (1067mm x 724mm)
SB100	60-5/8" (1540mm)	61-5/8" (1565mm)	70-1/2" (1791)	71" (1803mm)	29-1/2" (749mm)	30-1/2" (775mm)	41-5/8" (1057mm)	61-5/8" (1565mm)	50" x 33" (1270mm x 838mm)

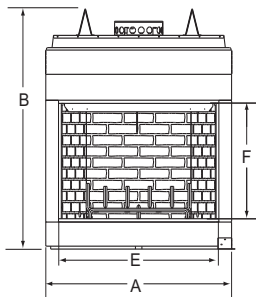

Front View

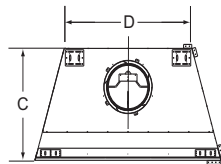

Top View

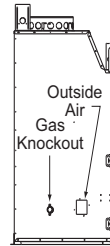

Left Side View

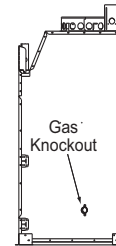

Right Side View

Sovereign

MODEL	FRONT WIDTH (A)		HEIGHT (B)		DEPTH (C)		REAR WIDTH (D)		FIREPLACE OPENING (E X F)
	ACTUAL	FRAMING	ACTUAL	FRAMING	ACTUAL	FRAMING	ACTUAL	FRAMING	
SA36	42" (1067mm)	43" (1092mm)	41-1/4" (1048mm)	41-1/2" (1054mm)	22-3/4" (578mm)	23" (584mm)	28-1/4" (718mm)	43" (1092mm)	36" x 23-3/8" (914mm x 594mm)
SA42	48" (1219mm)	49" (1245mm)	41-1/4" (1048mm)	41-1/2" (1054mm)	22-3/4" (578mm)	23" (584mm)	30-7/8" (784mm)	49" (1245mm)	42" x 23-3/8" (1067mm x 594mm)

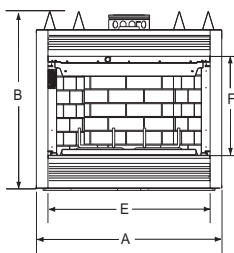

Front View

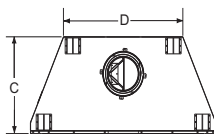

Top View

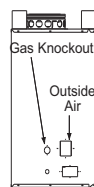

Left Side View

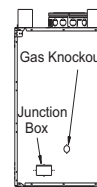

Right Side View

Royalton

MODEL	FRONT WIDTH (A)		HEIGHT (B)		DEPTH (C)		REAR WIDTH (D)		FIREPLACE OPENING (E X F)
	ACTUAL	FRAMING	ACTUAL	FRAMING	ACTUAL	FRAMING	ACTUAL	FRAMING	
BE36	41" (1041mm)	42" (1067mm)	39-1/2" (1003mm)	39-3/4" (1010mm)	21-3/8" (543mm)	21-1/2" (546mm)	23-3/4" (603mm)	42" (1067mm)	36" x 21" (914mm x 533mm)
BE42	47" (1194mm)	48" (1219mm)	39-1/2" (1003mm)	39-3/4" (1010mm)	21-3/8" (543mm)	21-1/2" (546mm)	29-3/4" (756mm)	48" (1219mm)	42" x 21" (1067mm x 533mm)

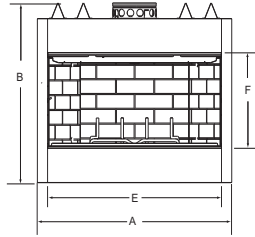

Front View

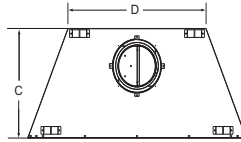

Top View

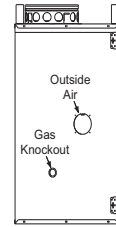

Left Side View

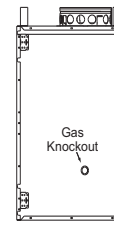

Right Side View

Designer See-Through

MODEL	FRONT WIDTH (A)		HEIGHT (B)		DEPTH (C)		REAR WIDTH (D)		FIREPLACE OPENING (E X F)
	ACTUAL	FRAMING	ACTUAL	FRAMING	ACTUAL	FRAMING	ACTUAL	FRAMING	
DSR42	47" (1194mm)	48" (1219mm)	58-7/8" (1496mm)	39-1/8" ² (994mm)	28" (711)	27" (686mm)	47" (1194mm)	48" (1219mm)	42" x 23" (1067mm x 585mm)

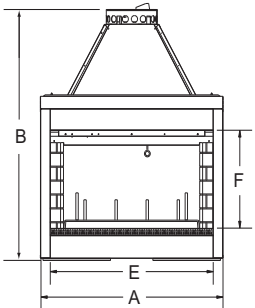

Front View

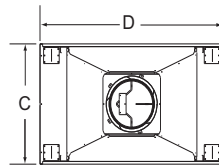

Top View

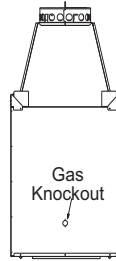

Left Side View

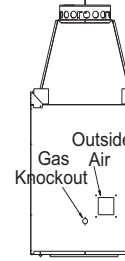

Right Side View



Learn More
about our wood products



Learn More
about our Gas Logs

Your Majestic Dealer:



Our Sustainability Story Our history of leadership in the hearth industry compels us to now lead the way in developing manufacturing practices that ensure our planet remains as durable, beautiful and long-lasting as our products.

Find out how we are leading the industry in sustainable practices by scanning the code.

Limited Lifetime Warranty³

The strongest in the industry, Majestic provides a limited lifetime warranty on the most important aspects of our wood-burning products: firebox and heat exchanger.



majesticproducts.com
majesticfireplaces.ca

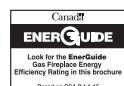

¹ Order a conversion kit when using LP. ² Refer to installation instructions for zero clearance install guidelines. ³ For full warranty details go to majesticproducts.com. The information provided in this literature is for planning purposes only and subject to change. Please consult the installation instructions for actual installation. Actual product appearance may differ from product images. Fireplace, stove and insert surfaces get extremely HOT and can cause severe burns if touched. Keep a safe distance away. To learn more visit www.majesticproducts.com. ©2023 Hearth & Home Technologies®
Google and Google Home are trademarks of Google LLC. Amazon, Alexa, and all related logos are trademarks of Amazon.com, Inc. or its affiliates.