

Owner's Manual

Care and Operation

Pour demander un exemplaire en français de ce Manuel du propriétaire, visitez www.majestic-products.com/translations.

INSTALLER: Leave this manual with party responsible for use and operation.

OWNER: Retain this manual for future reference.

NOTICE: *DO NOT* discard this manual!

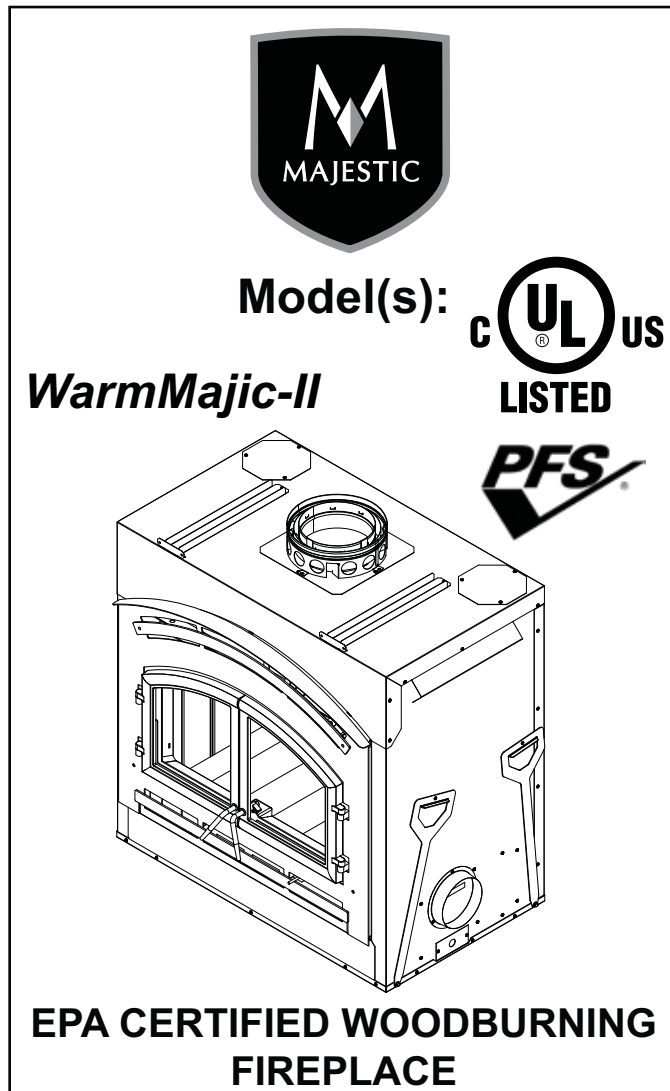

Installation and service of this appliance should be performed by qualified personnel. Hearth & Home Technologies recommends HHT Factory Trained or NFI certified professionals.

hearthED
FACTORY TRAINING
Fuel Your Fire

NFI NATIONAL FIREPLACE INSTITUTE
A CERTIFICATION AGENCY

⚠ WARNING: If the information in these instructions is not followed exactly, a fire or explosion may result causing property damage, personal injury, or death.

- **DO NOT** store or use gasoline or other flammable vapors and liquids in the vicinity of this or any other appliance.
- **DO NOT** overfire. Overfiring will void your warranty.
- Comply with all minimum clearances to combustibles as specified. Failure to comply may cause house fire.

⚠ WARNING



HOT SURFACES!

Glass and other surfaces are hot during operation AND cool down.

Hot glass will cause burns.

- **DO NOT** touch glass until it is cooled
 - **NEVER** allow children to touch glass
 - Keep children away
 - **CAREFULLY SUPERVISE** children in same room as fireplace.
 - Alert children and adults to hazards of high temperatures.
- High temperatures may ignite clothing or other flammable materials.**
- Keep clothing, furniture, draperies and other flammable materials away.

⚠ WARNING



Fire Risk.

For use with solid wood fuel only.

Other fuels may overfire and generate poisonous gases (i.e. carbon monoxide).



4188-900

Safety Alert Key:

- **DANGER!** Indicates a hazardous situation which, if not avoided will result in death or serious injury.
- **WARNING!** Indicates a hazardous situation which, if not avoided could result in death or serious injury.
- **CAUTION!** Indicates a hazardous situation which, if not avoided, could result in minor or moderate injury.
- **NOTICE:** Indicates practices which may cause damage to the fireplace or to property.

Table of Contents

1 Welcome		4 Maintenance and Service	
A. Congratulations	3	A. Maintenance Tasks-Homeowners	17
B. LIMITED LIFETIME WARRANTY	4	1. Chimney Inspection	17
2 Product Specific Information		2. Creosote (Chimney) Cleaning	18
A. Appliance Certification	6	3. Care and Cleaning of Plated Surfaces	19
B. BTU & Efficiency Specifications	6	4. Glass Door	19
C. Mobile Home Approved	6	5. Glass Cleaning	19
D. Glass Specifications	6	6. Door Gasket	19
3 Important Safety and Operating Information		7. Ash Removal	19
A. Fireplace Safety	7	8. Baffle and Blanket	19
1. Clear Space	7	9. Firebrick	19
2. Firebrick	8	B. Replacement Maintenance	20
3. Baffle and Blanket	8	1. Glass Replacement	20
4. Over-Firing Your Fireplace	8	2. Tighten or Adjust Door Latch	20
5. Chimney Fire	8	3. Door Handle Assembly	21
B. General Operating Parts	9	4. Firebrick Replacement	21
1. Automatic Combustion Control (ACC)	10	5. Baffle Removal and Installation	22
2. ACC Override	10	6. Fan Replacement	22
3. Outside Air	10	7. Timer Assembly Replacement	23
4. Glass Doors	11	8. Timer Removal and Replacement	25
5. Convection Fan Operation	11	9. Fan Snap Disc	27
C. Fuel	11	5 Troubleshooting	
1. Hardwood vs. Softwood	12	A. FAQs	28
2. Moisture Content	12	B. Troubleshooting Table	30
3. Seasoning	12	6 Reference Materials	
4. Storing Wood	13	▶ A. Service Parts	31
5. Burning Process	13	B. Contact Information	36
6. Dirty Glass	13		
7. Creosote Formation	13		
8. Opacity	13		
D. First Fire	13		
E. Lighting Instructions/Establish Coal Bed	14		
F. Frequently Asked Questions	16		

1 Welcome

Read this manual before installing or operating this fireplace.
Please retain this owner's manual for future references.

A. Congratulations

Congratulations on selecting a Majestic wood burning fireplace. The Majestic fireplace you have selected is designed to provide the utmost in safety, reliability, and efficiency.

As the owner of a new fireplace, you'll want to read and carefully follow all of the instructions contained in this Owner's Manual. Pay special attention to all Cautions and Warnings.

This Owner's Manual should be retained for future reference. We suggest that you keep it with your other important documents and product manuals.

Your new Majestic wood burning fireplace will give you years of durable use and trouble-free enjoyment. Welcome to the Majestic family of fireplace products!

Majestic is a registered trademark of Hearth & Home Technologies.

Local Dealer Information

DEALER: Fill in your name, address, phone and email information here and fireplace information below.

Dealer Name: _____
 Address: _____

 Phone: _____
 Email: _____

Fireplace Information:

Brand: _____ Model Name: _____
 Serial Number: _____ Date Installed: _____

Listing Label Information/Location

The model information regarding your specific fireplace can be found on the rating plate usually located in the control area of the fireplace.



UL LISTED
UL 127-2011, CAN/ULC-S610

Model:
WarmMajic
EPA CERTIFIED FIREPLACE



A brand of Hearth & Home Technologies
7571 - 215th Street West, Lakeville, MN, 55044
www.majesticproducts.com

SERIAL NO./NUMERO DESERE
MP188

MODEL
WarmMajic-II

FIRE CHAMBER INTENDED FOR USE WITH HEARTH & HOME TECHNOLOGIES LISTED FIREPLACE PARTS. SEE INSTALLATION AND OPERATING INSTRUCTIONS FOR THIS MODEL. REPLACE GLASS ONLY WITH CERAMIC.

DO NOT OVERFIRE. USE ONLY SOLID WOOD FUEL. DO NOT USE A FIREPLACE INSERT OR OTHER PRODUCTS NOT SPECIFIED FOR USE WITH THIS PRODUCT.

WARNING! THIS FIREPLACE HAS NOT BEEN TESTED WITH AN UNVENTED GAS LOG SET. TO REDUCE THE RISK OF FIRE OR INJURY, DO NOT INSTALL AN UNVENTED GAS LOG SET INTO FIREPLACE.

DO NOT USE GRATE OR ELEVATE FIRE. BUILD WOOD FIRE DIRECTLY ON FIREBRICK.

WARNING! TO AVOID THE RISK OF DAMAGING FIREPLACE MATERIALS AND INCREASING THE RISK OF SPREADING A FIRE DO NOT USE THE FIREPLACE TO COOK OR WARM FOOD.

INSTALL AND USE ONLY IN ACCORDANCE WITH MANUFACTURER'S INSTALLATION, VENTING AND OPERATING INSTRUCTIONS. ANY AREA INCORPORATING WARM OR COLD AIR DUCTS SHALL BE ENCLOSED IN ACCORDANCE WITH THE MANUFACTURER'S INSTALLATION INSTRUCTIONS. CONTACT YOUR LOCAL BUILDING OR FIRE OFFICIALS OR AUTHORITY HAVING JURISDICTION ABOUT RESTRICTIONS, INSTALLATION INSPECTION AND PERMITS REQUIRED IN YOUR AREA.

COMPONENTS REQUIRED FOR INSTALLATION: HHT SL300 SERIES PIPE OR DURAVENT DURA PLUS SYSTEM, TERMINATION CAP, HEARTH EXTENSION AND REQUIRED ACCESSORY CHIMNEY AIR KIT PART CAK4A.

DO NOT CONNECT THIS UNIT TO A CHIMNEY SERVING ANOTHER APPLIANCE.

DANGER: RISK OF ELECTRICAL SHOCK. DISCONNECT POWER SUPPLY BEFORE SERVICING.

ELECTRICAL RATING: 115 VAC <3.0 AMPS 60 HZ
MUST PROVIDE A SOURCE OF AIR TO PREVENT AIR STARVATION FROM COMBUSTION WHICH COULD RESULT IN HIGH LEVELS OF CARBON MONOXIDE.

FIREPLACE ALSO FOR USE IN MANUFACTURED/MOBILE HOMES WITH SOLID FUEL ONLY YES NO

FIREPLACE FOR USE OUTDOORS YES NO

FIREBOX TYPE

BACK	1/2	IN. MIN.
RETOUR	13	MM MIN.
SIDE	1	IN. MIN.
COTE	25	MM MIN.

CLEARANCE TO COMBUSTIBLES: 2 IN. MIN.
DEGAJEMENT DES MATEAUX COMBUSTIBLES: 51 MM

IF INSTALLATION OR OPERATING INSTRUCTIONS ARE MISSING CONTACT HEARTH & HOME TECHNOLOGIES, 7571 215th Street West, Lakeville, MN 55044

THE HEARTH EXTENSION MUST BE INSTALLED ACCORDING TO THE INSTALLATION INSTRUCTIONS.

This wood heater needs periodic inspection and repair for proper operation. Consult owner's manual for further information. It is against federal regulations to operate this wood heater in a manner inconsistent with the operating instructions in the owner's manual.

DO NOT REMOVE THIS LABEL Made in U.S.A. of US and imported parts

Mfg by:  HEARTH & HOME technologies

U.S. ENVIRONMENTAL PROTECTION AGENCY - Certified to comply with 2020 particulate emission standards using cord wood. This wood heater was found to have an average emissions rate of 2.0g/hr using method ASTM E3053-17.

2019 2020 2021 2022 2023 2024 Jan Feb Mar Apr May June July Aug Sept Oct Nov Dec

4188-990A

Model Number
Serial Number

B. LIMITED LIFETIME WARRANTY

Hearth & Home Technologies LLC LIMITED WARRANTY

Hearth & Home Technologies LLC (“HHT”) extends the following warranty for HHT gas, wood, pellet and electric hearth appliances (each a “Product” and collectively, the “Product(s)”) and certain component parts set forth in the table below (“Component Part(s)”) that are purchased from a HHT authorized dealer or distributor.

WARRANTY COVERAGE:

HHT warrants that the Products and their Component Parts will be free from defects in materials and workmanship for the applicable period of Warranty coverage set forth in the table below (“Warranty Period”). If a Product or Component Parts are found to be defective in materials or workmanship during the applicable Warranty Period, HHT will, at our discretion, repair the applicable Component Part(s), replace the applicable Component Part(s), or refund the purchase price of the applicable Product(s). The maximum amount recoverable under this Warranty is limited to the purchase price of the Product. This Warranty is transferable from the original purchaser to subsequent owners, but the Warranty Period will not be extended in duration or expanded in coverage for any such transfer. This Warranty is subject to conditions, exclusions, and limitations as described below.

WARRANTY PERIOD:

Warranty coverage begins at the date of installation. In the case of new home constructions, Warranty coverage begins six months after invoice of the final sale of the Product(s) by an independent, authorized HHT dealer or distributor. However, the Warranty coverage shall commence no later than 24 months following the date of Product shipment from HHT, regardless of the installation or purchase date.

Warranty Period		HHT Manufactured Appliances and Venting					
Component Parts	Labor	Gas	Pellet	Wood	Electric	Component Parts Covered by this Warranty	
1 Year		X	X	X		All parts including handles, external enameled components and other material except as covered by Warranty Conditions, Warranty Exclusions, and Warranty Limitations listed	
2 Years					X	All parts except as covered by Warranty Conditions, Warranty Exclusions, and Warranty Limitations listed	
			X	X		Glass, Electrical components limited to heating element/igniters, Top feed auger assembly, Blowers, Junction Box, Remotes/Wall switches, linear actuator, power cord, vacuum switch, snap disc, wire harnesses and thermocouple	
		X				Electrical components limited to modules, remotes/wall switches, valves, pilots, blowers, junction boxes, wire harnesses, transformers and lights (excluding light bulbs)	
		X		X		Cement Refractory Panels, Glass Liner Panels	
3 years			X			Firepots, burnpots, Harman mechanical feeders	
5 years		X		X		Catalysts, Vented and Vent Free burners and logs	
10 years	1 year	X				Burners, logs and metal/fiber refractory components of HHT manufactured fireplaces or stoves, venting due to poor workmanship	
10 years	3 years		X	X		Castings, Medallions & Baffles, FlexBurn® System (engine, inner cover, access cover and fireback), Firebox and heat exchanger, HHT Chimney & Terminations, Manifolds	
20 years	3 years	X				Firebox and heat exchanger	
All purchased replacement parts and optional accessories							
1 Year	None	X	X	X	X	All purchased replacement parts and optional accessories	

WARRANTY CONDITIONS:

- Because HHT cannot control the quality of any Products sold by unauthorized sellers, this Warranty only covers Products that are purchased through an HHT authorized dealer or distributor unless otherwise prohibited by law; a list of HHT authorized dealers is available on the HHT branded websites.
- This Warranty is only valid while the applicable Product remains at the site of original installation.
- This Warranty is only valid in the country in which the HHT authorized dealer or distributor that sold the applicable Product is authorized to sell applicable Product.
- Contact your installing distributor or dealer for Warranty service. If the installing dealer or distributor is unable to provide necessary parts, contact the nearest HHT authorized dealer or supplier. Additional service fees may apply if you are seeking Warranty service from a dealer other than the dealer from whom you originally purchased the applicable Product.
- No HHT consumer should bear cost of warranty service or costs incurred while servicing warranty claims (i.e., travel, gas, or mileage) when the service is performed within the terms of this Warranty. Check with your dealer or distributor in advance for any costs to you when arranging a warranty call. Travel and shipping charges for parts are not covered by this Warranty.

WARRANTY EXCLUSIONS:

This Warranty does not cover the following:

- Changes in surface finishes as a result of normal use. As a heating appliance, some changes in color of interior and exterior surface finishes may occur. This is not a flaw and is not covered under the Warranty.
- Damage to printed, plated, or enameled surfaces caused by fingerprints, accidents, misuse, scratches, melted items or other external sources and residues left on the plated surfaces from the use of abrasive cleaners or polishes.
- Repair or replacement of parts that are subject to normal wear and tear during the Warranty Period are not covered. These parts include: paint, wood and pellet gaskets, firebricks, wood grates, flame guides, batteries and the discoloration of glass.
- Minor expansion, contraction, or movement of certain parts causing noise. These conditions are normal and complaints related to this noise are not covered by this Warranty.
- Damages resulting from: (1) failure to install, operate, or maintain the applicable Product in accordance with the installation instructions, operating instructions, and listing agent identification label furnished with the applicable Product; (2) failure to install the applicable Product in accordance with local building codes; (3) shipping or improper handling; (4) improper operation, abuse, misuse, continued operation with damaged, corroded or failed components, accident, or improperly/incorrectly performed repairs; (5) environmental conditions, inadequate ventilation, negative pressure, or drafting caused by tightly sealed constructions, insufficient make-up air supply, or handling devices such as exhaust fans or forced air furnaces or other such causes; (6) use of fuels other than those specified in the operation instructions; (7) installation or use of components not supplied with the applicable Product or any other components not expressly authorized and approved by HHT; (8) modification of the appliance not expressly authorized and approved by HHT in writing; and/or (9) interruptions or fluctuations of electrical power supply to the applicable Product.
- Non-HHT venting components, hearth connections or other accessories used in conjunction with the applicable Product.
- Any part of a pre-existing fireplace system in which an insert or a decorative gas applicable Product is installed.
- HHT's obligation under this Warranty does not extend to the Product's capability to heat the desired space. Information is provided to assist the consumer and the dealer in selecting the proper Product for the application. Consideration must be given to the Product location and configuration, environmental conditions, insulation and air tightness of the structure.

This warranty is void if:

- The applicable Product has been over-fired, operated in atmospheres contaminated by chlorine, fluorine, or other damaging chemicals. Over-firing can be identified by, but not limited to, warped plates or tubes, deformation/warping of interior cast iron structure or components, rust colored cast iron, bubbling, cracking and discoloration of steel or enamel finishes.
- The applicable Product is subjected to prolonged periods of dampness or condensation.
- There is any damage to the applicable Product due to water or weather damage which is the result of, but not limited to, improper chimney or venting installation.

LIMITATIONS OF REMEDIES AND LIABILITY:

- **EXCEPT TO THE EXTENT PROVIDED BY LAW, HHT MAKES NO EXPRESS WARRANTIES OTHER THAN THE WARRANTY SPECIFIED HEREIN. The owner's exclusive remedy and HHT's sole obligation under this Warranty or in contract, tort or otherwise, shall be limited to, at HHT's sole option, replacement of the Component Part(s), repair of the Component Part(s), or refund of the original purchase price of the applicable Product(s). In no event will HHT be liable for any incidental or consequential damages caused by defects in the applicable Product. Some States do not allow the exclusion or limitation of incidental or consequential damages, so the above limitation or exclusion may not apply to you. This Warranty gives you specific legal rights and you may also have other rights which vary from State to State. THE DURATION OF ANY IMPLIED WARRANTY IS LIMITED TO DURATION OF THE EXPRESSED WARRANTY SPECIFIED ABOVE FOR THE APPLICABLE PRODUCT. Some States do not allow limitations on how long an implied warranty lasts, so the above limitation may not apply to you.**

2 Listing and Code Approvals

A. Appliance Certification

Model:	WarmMajic-II
Laboratory:	Underwriters Laboratories, Inc.
Report No:	Project 4789042842
Type:	Wood Fireplace
Standard:	UL 127 - 2011 and CAN/ULC S610-2018 (A1998) and (UM) 84-HUD, Manufactured Home Approved.

B. BTU & Efficiency Specifications

EPA Certified Emissions:	1.8 g/hr
*LHV Tested Efficiency:	76%
**HHV Tested Efficiency:	70%
***EPA BTU Output:	17,600 to 48,200
Vent Size:	8 inches
Firebox Size:	2.7 cubic feet
Recommended Log Length:	22 inches
Fuel	Seasoned Cord Wood less than 20% moisture
*Weighted average LHV (Low Heating Value) efficiency using cord wood and data collected during EPA emission test. LHV assumes the moisture is already in a vapor state so there is no loss in energy to vaporize.	
**Weighted average HHV (High Heating Value) efficiency using cord wood and data collected during EPA emission test. HHV includes the energy required to vaporize the water in the fuel.	
***A range of BTU outputs based on HHV and the burn rates from the low and high EPA tests, using cord wood.	

The WarmMajic-II is Certified to comply with 2020 particulate emission standards.



The WarmMajic-II Wood Appliance meets the U.S. ENVIRONMENTAL PROTECTION AGENCY Certified to comply with 2020 particulate emission standards using cord wood.

This wood heater needs periodic inspection and repair for proper operation. It is against federal regulations to operate this wood heater in a manner inconsistent with operating instructions in this manual.

C. Mobile Home Approved

- This appliance is approved for mobile home installations when not installed in a sleeping room and when an outside combustion air inlet is provided.
- The structural integrity of the mobile home floor, ceiling, and walls must be maintained.
- The appliance must be properly grounded to the frame of the mobile home with #8 copper ground wire.
- Outside Air Kit must be installed in a mobile home installation.

D. Glass Specifications

This fireplace is equipped with 5mm ceramic glass. Replace glass only with 5mm ceramic glass. Please contact your dealer for replacement glass.

WARNING



Fire Risk.

Hearth & Home Technologies disclaims any responsibility for, and the warranty will be voided by, the following actions:

- Installation and use of any damaged appliance.
- Modification of the appliance.
- Installation other than as instructed by Hearth & Home Technologies.
- Installation and/or use of any component part not approved by Hearth & Home Technologies.
- Operating appliance without fully assembling all components.
- Do NOT Overfire - If appliance or chimney connector glows, you are overfiring.

Any such action that may cause a fire hazard.

Improper installation, adjustment, alteration, service or maintenance can cause injury or property damage.

For assistance or additional information, consult a qualified installer, service agency or your dealer.

NOTE: Hearth & Home Technologies, manufacturer of this appliance, reserves the right to alter its products, their specifications and/or price without notice.

Majestic is a registered trademark of Hearth & Home Technologies.

3 Important Safety and Operating Information

A. Fireplace Safety

Most problems are caused by improper installation and operation of the fireplace. To provide reasonable fire safety, the following should be given serious consideration:

- The fire should be supervised whenever the fireplace is in use.
- An annual inspection should be performed on the fireplace system.
- Install at least one smoke detector on each floor of your home to ensure your safety.
- Install a CO detector in the room with the fireplace.
- Install a conveniently located Class A fire extinguisher near the fireplace.
- Devise a practiced evacuation plan, consisting of at least two escape routes.
- Devise a plan to deal with a chimney fire:
 - Close all openings into the fireplace.
 - Evacuate.
 - Notify the fire department.

WARNING! Risk of Fire! *Hearth & Home Technologies disclaims any responsibility for, and the warranty and agency listing will be voided by the following actions.*

DO NOT:

- operate damaged fireplace
- modify fireplace
- overfire
- install any gas log set
- install any component not approved by *Hearth & Home Technologies*
- install parts or components not Listed or approved
- operate the fireplace without fully assembling all components

Improper installation, adjustment, alteration, service or maintenance can cause injury or property damage.



WARNING: This product and the fuels used to operate this product (wood and wood pellets), and the products of combustion of such fuels, can expose you to chemicals including carbon black, which is known to the State of California to cause cancer and carbon monoxide, which is known to the State of California to cause birth defects or other reproductive harm. For more information go to: www.P65Warnings.ca.gov.

1. Clear Space

Combustible materials must not be stored on the hearth extension. Room furnishings such as drapes, curtains, chairs or other combustibles must be at least 4 ft (1219 mm) from the open front of the fireplace.

Combustible materials are materials made of or surfaced with any of the following materials:

- Wood
- Plant fibers
- Plywood/OSB
- Compressed paper
- Plastic
- Drywall
- Any material that can ignite and burn, flame proofed or not, plastered or un-plastered.

Non-combustible materials are materials which will not ignite and burn, composed of any combination of the following:

- Steel
- Brick
- Concrete
- Glass
- Iron
- Tile
- Slate
- Plasters

WARNING! Risk of Fire! *Keep combustible materials, gasoline and other flammable vapors and liquids clear of the fireplace.*

DO NOT:

- store flammable materials close to the fireplace
- use gasoline, lantern fuel, kerosene, charcoal lighter fluid or similar liquids to start or "freshen up" a fire in this fireplace.

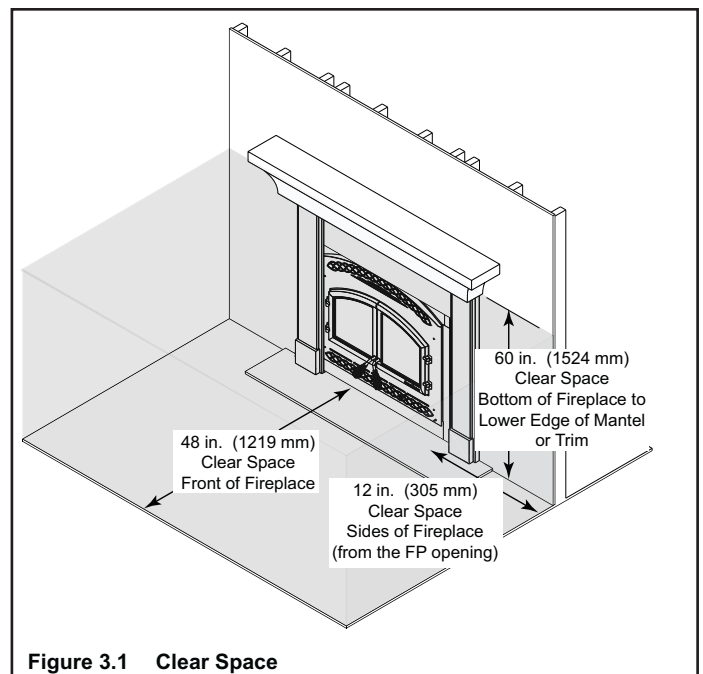

Figure 3.1 Clear Space

2. Firebrick

Your fireplace is lined with high quality firebrick, which has exceptional insulating properties.

Do not operate the fireplace without bricks. Make sure bricks are installed as shown in Section 4.

Do not use a grate; simply build a fire on the firebox floor.

3. Baffle and Blanket

Ensure correct baffle and baffle protection channel placement; replace baffle components if damaged or missing. (Please refer to Section 4.)

NOTICE: Firebox damage due to improper baffle placement is not covered by warranty. Operate the wood burning fireplace with the baffle in the correct position only. Not doing so could result in:

- reduced efficiency
- overheating the chimney
- overheating the rear of the firebox
- poor performance

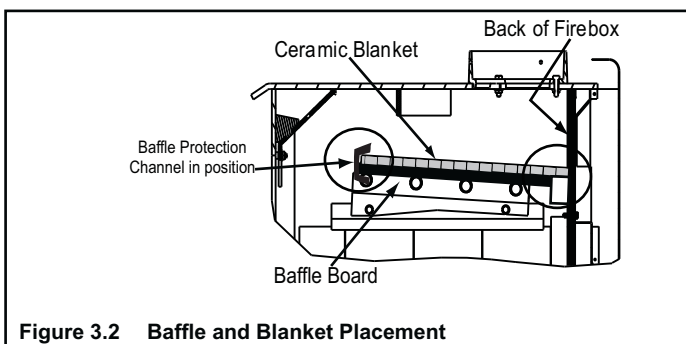

Figure 3.2 Baffle and Blanket Placement

The baffle board must be in contact with the back of the firebox. The ceramic blanket should lay on top of the baffle board.

The baffle protection channel should be in position and cover the front of the blanket and baffle board.

4. Over-Firing Your Fireplace

DO NOT OVERFIRE THIS FIREPLACE UNIT

Attempts to achieve heat output rates that exceed design specifications can result in permanent damage to the fireplace.

To prevent over-firing your fireplace. **DO NOT:**

- use flammable liquids
- overload with wood
- burn trash or large amounts of scrap lumber
- permit too much air to the fire (leaving the door open)

Symptoms of over-firing may include one or more of the following:

- chimney connector or fireplace glowing
- roaring, rumbling noises
- loud cracking or banging sounds
- metal warping
- chimney fire

What to do if your fireplace is over-firing:

- Immediately close the door and air controls to reduce air supply to the fire.
- If you suspect a chimney fire, call the fire department and evacuate your house.
- Contact your local chimney professional and have your fireplace and chimney inspected for any damage.
- Do not use your fireplace until the chimney professional informs you it is safe to do so.
- Hearth & Home Technologies WILL NOT warranty fireplaces that exhibit evidence of over-firing. Evidence of over-firing includes, but is not limited to:
 - warped air tube
 - deteriorated refractory brick
 - deteriorated baffle and other interior components

5. Chimney Fire

In the event of a chimney fire:

- Have the chimney and adjacent structure inspected by qualified professionals. Hearth & Home Technologies recommends that NFI or CSIA certified professionals, or technicians under the direction of certified professionals, conduct an inspection of the chimney per the criteria in NFPA 211.
- Replace components of the chimney and fireplace as specified by the professionals.
- Ensure all joints are properly engaged and the chimney is properly secured.

WARNING! Risk of Fire! A chimney fire can permanently damage your chimney system. Failure to replace damaged components and make proper repairs can cause a structure fire.

WARNING



HOT SURFACES!

Glass and other surfaces are hot during operation AND cool down.

Hot glass will cause burns.

- **DO NOT** touch glass until it is cooled
- NEVER allow children to touch glass
- Keep children away
- CAREFULLY SUPERVISE children in same room as fireplace.
- Alert children and adults to hazards of high temperatures.

High temperatures may ignite clothing or other flammable materials.

- Keep clothing, furniture, draperies and other flammable materials away.

B. General Operating Parts

WARNING! DO NOT operate fireplace before reading and understanding operating instructions. Failure to operate fireplace according to operating instructions could cause fire or injury.

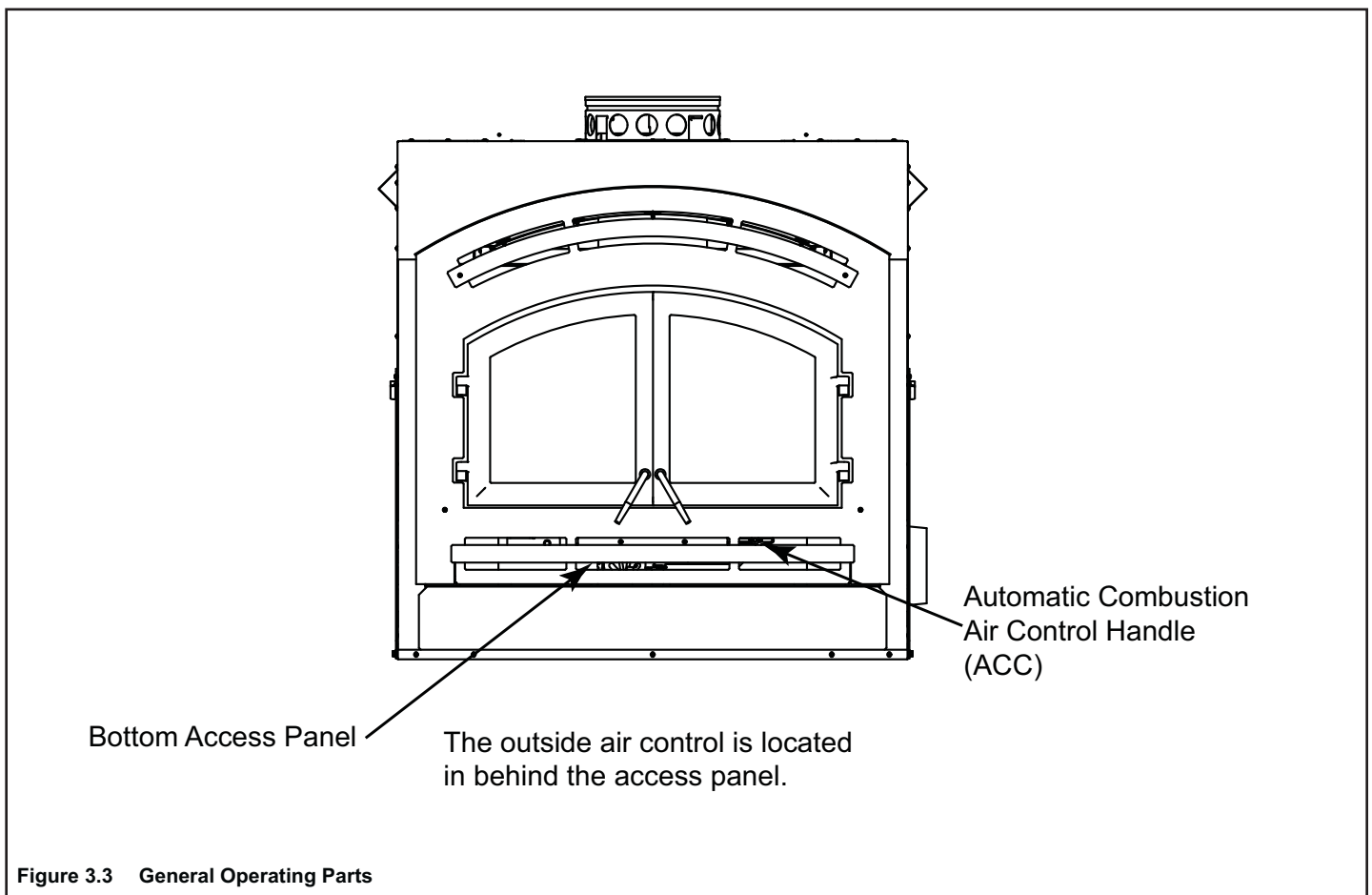

1. Automatic Combustion Control (ACC)

The automatic combustion control system allows you to set the fireplace to high (slide the combustion air control all the way to the right), start the fire, and then move the combustion air control to the desired burn level. The fire will automatically go to that level once it is fully established. This allows for less interaction with the fire by the homeowner and more efficient use of fuel while maintaining the desired heat output.

After the fireplace becomes hot, you may prefer to not activate the ACC when reloading fuel. If you do not slide the combustion air control all the way to the right, the ACC will not be activated.

NOTICE: If reloading a bright, hot coal bed for longer (low) burn time, setting the ACC may not be required. Burn dry, well seasoned wood.

NOTICE: To establish your settings, always begin with the air control all the way to the left to CLOSED and then move it to the right for your desired setting.

IMPORTANT! As you move the combustion air control to the RIGHT, you will feel resistance about three-fourths of the way. You must move past that resistance approximately 1 in. (25mm) to fully engage the automatic combustion control (ACC) system.

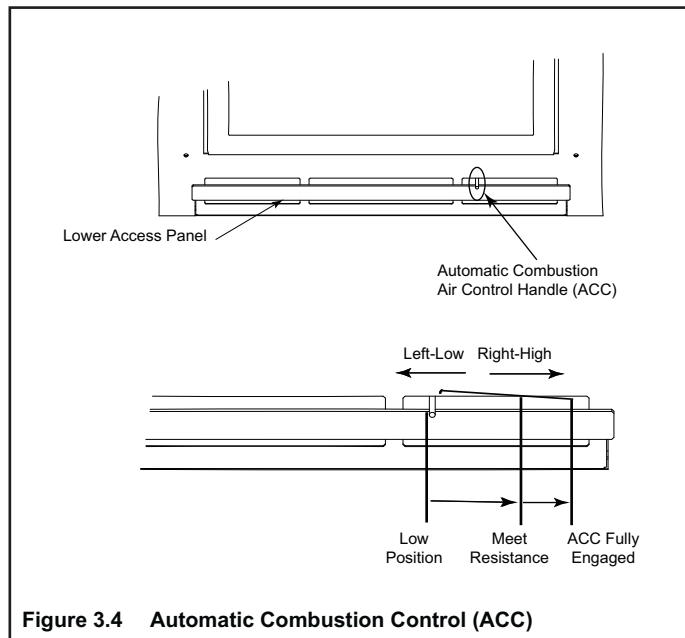

Figure 3.4 Automatic Combustion Control (ACC)

2. ACC Override

The ACC OVERRIDE lever is located behind the lower access panel (See Figure 3.4) and may be used to override the setting of the automatic combustion air control. If the ACC has been activated and burn rate needs to be slowed, remove the bottom access panel by lifting it up and pulling it off. To close down the air supply for an over-fire situation or to slow the burn rate down immediately, slide the linkage to the left. See Figure 3.5.

Slide the combustion air control all the way to the left also. Reinstall the access panel.

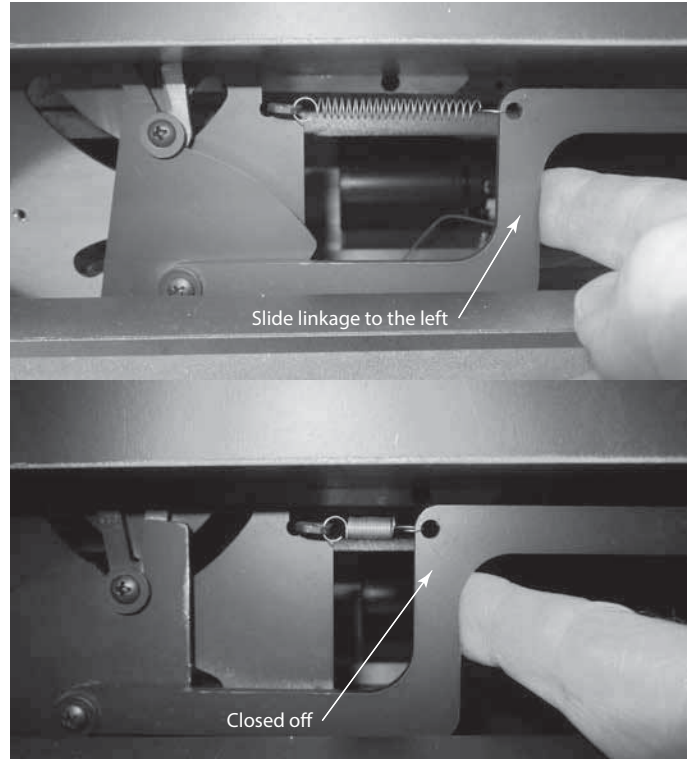

Figure 3.5 ACC Override

3. Outside Air

NOTICE: Use of outside air is required.

CAUTION! Outside air control handle may be warm. Allow unit to cool down before closing.

A source of air (oxygen) is required in order for combustion to take place.

1. Before lighting the fire open the bottom access panel by lifting it up and pulling it off.
2. Locate the handle on either the left or right side. Lift the handle up and pull out to open the door (pushing the handle in will close the door).
3. Reinstall the bottom access panel.

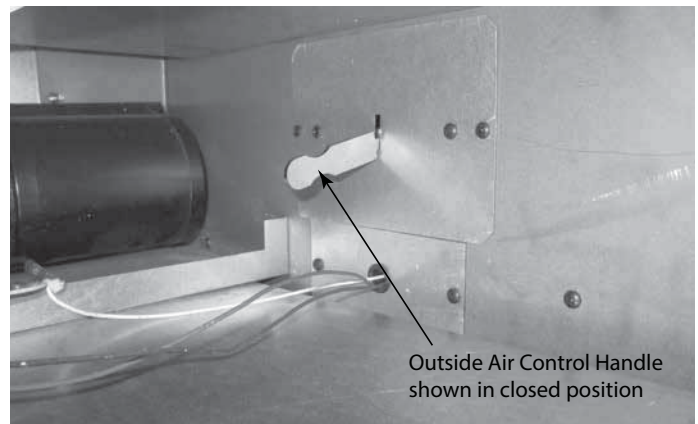

Figure 3.6 Outside Air Control Handle

4. Glass Doors

This fireplace has been tested and is intended for use with doors as supplied with this fireplace.

WARNING! Risk of Fire and Smoke! Fireplace should be operated only with doors fully open or doors fully closed. If doors are left partly open, gas and flame may be drawn out of the fireplace opening.

A firescreen (Mesh-HHT-C) must be used to control sparks if the homeowner chooses to operate the fireplace with the doors open.

WARNING! Fire Risk!

- Use firescreen when burning fireplace with doors open.
- Do not use firescreen or glass doors to hold burning material in fireplace.

Firescreen controls sparks.

Glass may break or burning material may roll out.

Only the screen specifically tested and listed for use with this fireplace model should be used.

WARNING! RISK OF Fire! Do NOT install and or use any component not approved by Hearth & Home Technologies

Always wear gloves when installing or removing the screen as the screen may become extremely hot while in use.

5. Convection Fan Operation

The fireplace is equipped with a temperature-sensitive snap disc that will turn the convection fan on and off automatically, depending on the temperature of the fireplace.

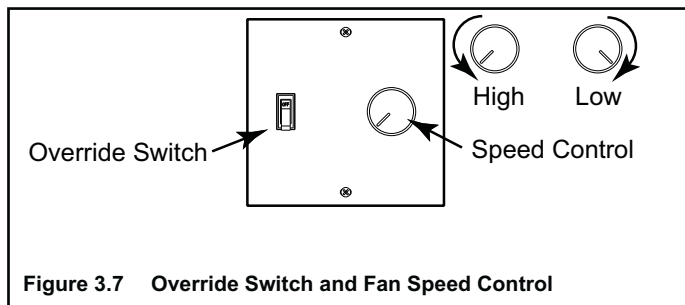

Figure 3.7 Override Switch and Fan Speed Control

An override switch and fan speed control have been installed on the wall in close proximity to the fireplace.

The speed of the fan can be regulated by the speed control knob.

If the fan is not coming on at the desired time, flip the override switch to manual and operate the fan as described below:

• **Initial (cold) Startup**

Leave fan off until your fireplace is hot and a good coal bed is established, approximately 30 minutes after fuel is lit.

• **High Burn Setting**

The fan may be left on throughout the burn.

• **Medium or Medium High Burn Setting**

The fan should be left off until a good burn is established, then turned on medium or high rate.

• **Low Burn Setting**

The fan tends to cool off the fireplace. Leave fan off until the burn is well established; then, if you wish, turn the fan on at a low rate.

C. Fuel

WARNING! For use with solid wood fuel only.

Other fuels may overfire and generate poisonous gases (i.e. carbon monoxide).

This fireplace is designed to burn natural wood only. Higher efficiencies and lower emissions generally result when burning air dried seasoned hardwoods, as compared to softwoods or to green or freshly cut hardwoods. DO NOT BURN:

- Garbage
- Lawn clippings or yard waste
- Materials containing rubber, including tires
- Materials containing plastic
- Waste petroleum products, paints or paint thinners, or asphalt products
- Materials containing asbestos
- Construction or demolition debris
- Railroad ties or pressure-treated wood
- Manure or animal remains
- Salt water driftwood or other previously salt water saturated materials
- Unseasoned wood
- Paper products, cardboard, plywood, or particleboard.

The prohibition against burning these materials does not prohibit the use of fire starters made from paper, cardboard, saw dust, wax and similar substances for the purpose of starting a fire in an affected wood heater.

Burning these materials may result in release of toxic fumes or render the heater ineffective and cause smoke.

1. Hardwood vs. Softwood

Your fireplace's performance depends on the quality of the firewood you use. One species of wood varies very little to the other in terms of energy content. All seasoned wood contains about 8,000 BTU's per pound. Hardwoods have a greater density than softwoods; a piece of hardwood will contain about 60% more BTU's than an equal size piece of softwood. A cord of seasoned oak (hardwood) would contain about 60% more potential energy than a cord of seasoned pine (softwood).

Most softwoods are coniferous. These are trees with needle-like leaves that stay green all year and carry their seeds exposed in a cone. Examples of coniferous trees are Douglas fir, pine, spruce and cedar. Softwoods, being more porous, require less time to dry, burn faster and are easier to ignite than hardwoods. Hardwoods are deciduous trees, broadleaf trees that lose their leaves in the fall. Their seeds are usually found within a protective pod or enclosure. Some examples of deciduous trees are oak, maple, apple, and birch. However, it should be noted that there are some deciduous trees that are definitely not considered hardwoods such as poplar, aspen and alder. Hardwoods require more time to season, burn slower and are usually harder to ignite than softwoods. Obviously, you will use the type of wood that is most readily available in your area. However, if at all possible the best arrangement is to have a mix of softwood and hardwood. This way you can use the softwood for starting the fire, giving off quick heat to bring the fireplace up to operating temperature. Add the hardwood for slow, even heat and longer burn time.

WARNING! Risk of Fire!

- **DO NOT** burn wet or green wood.
- Wet, unseasoned wood can cause accumulation of creosote.

Soft woods	Hard woods
• Douglas Fir	• Oak
• Pine	• Maple
• Spruce	• Apple
• Cedar	• Birch
• Poplar	
• Aspen	
• Alder	

2. Moisture Content

The majority of the problems fireplace owners experience are caused by trying to burn wet, unseasoned wood. Freshly cut wood can be as much water as it is wood, having a moisture content of around 50%. Imagine a wooden bucket that weighs about 8 pounds. Fill it with a gallon of water, put it in the firebox and try to burn it. This sounds ridiculous but that is exactly what you are doing if you burn unseasoned wood. Dead wood lying on the forest floor should be considered wet, and requires full seasoning time. Standing dead wood can be considered to be about two-thirds seasoned, if cut at the dry time of the year.

Burning wet, unseasoned wood will produce less heat output because it requires energy in the form of heat to evaporate the water trapped inside. This is wasted energy that should be used for heating your home. This moisture evaporates in the form of steam which has a cooling effect in your firebox and chimney system. When combined with tar and other organic vapors from burning wood it will form creosote which condenses in the relatively cool firebox and chimney.

Even dry wood contains at least 15% moisture by weight, and should be burned hot enough to keep the chimney hot for as long as it takes to dry the wood out - about one hour. To tell if wood is dry enough to burn, check the ends of the logs. If there are cracks radiating in all directions from the center, it is dry. If your wood sizzles in the fire, even though the surface is dry, it may not be fully cured.

3. Seasoning

Seasoned firewood is nothing more than wood that is cut to size, split and air dried to a moisture content of around 20%. The time it takes to season wood varies from around nine months for soft woods to as long as eighteen months for hardwoods. The key to seasoning wood is to be sure it has been split, exposing the wet interior and increasing the surface area of each piece. A tree that was cut down a year ago and not split is likely to have almost as high a moisture content now as it did when it was cut.

To season wood:

- Cut logs to size
- Split to 6 in. (152 mm) or less
- Air dry to a moisture content of around 20%
 - Soft wood - about nine months
 - Hard wood - about eighteen months

NOTICE: Seasoning time may vary depending on drying conditions.

4. Storing Wood

Splitting wood before it is stored reduces drying time. The following guideline will ensure properly seasoned wood:

- Stack the wood to allow air to circulate freely around and through the woodpile.
- Elevate the woodpile off the ground to allow air circulation underneath.
- The smaller the pieces, the faster the drying process. Any piece over 6 in. (152 mm) in diameter should be split.
- Wood should be stacked so that both ends of each piece are exposed to air, since more drying occurs through the cut ends than the sides. This is true even with wood that has been split.
- Store wood under cover, such as in a shed, or covered with a tarp, plastic, tar paper, sheets of scrap plywood, etc., as uncovered wood can absorb water from rain or snow, delaying the seasoning process. Avoid covering the sides and ends completely. Doing so may trap moisture from the ground and impede air circulation.

5. Burning Process

Fire requires fuel, air and heat. If heat is robbed from the fireplace during the drying stage, the new load of wood has reduced the chances for a good clean burn. Always burn dry, seasoned firewood.

• Kindling or 1st stage:

In this stage, the wood is heated to a temperature high enough to evaporate the moisture which is present in all wood. The wood will reach the boiling point of water (212°F) and will not get any hotter until the water is evaporated. This process takes heat from coals and tends to cool the fireplace.

• 2nd stage:

The secondary stage is when the wood gives off flammable gases which burn above the fuel with bright flames. It is very important that the flames be maintained and not allowed to go out. This will ensure the cleanest possible fire. You should close down the air to control the point where you can still maintain some flame. If the flames tend to go out, more air is necessary.

• Final stage:

The final stage of burning is the charcoal stage. This occurs when the flammable gases have been mostly burned and only charcoal remains. This is a naturally clean portion of the burn. The coals burn with hot blue flames.

It is very important to reload your fireplace while enough lively hot coals remain in order to rekindle the next load of wood.

6. Dirty Glass

A portion of the combustion air entering the firebox is deflected down over the inside of the door glass. This air flow “washes” the glass, helping to keep smoke from adhering to its surface. When operated at a low burn rate, less air will be flowing over the glass and the smoky, relatively cool condition of a low fire will cause the glass to become coated. Operating the fireplace with the burn rate air control and start-up air control all the way open for 15-20 minutes should remove the built up coating.

7. Creosote Formation and Need For Removal

When wood is burned slowly, it produces tar and other organic vapors which combine with expelled moisture to form creosote. The creosote vapors condense in the relatively cool chimney flue of a newly-started or a slow-burning fire. As a result, creosote residue accumulates on the flue lining.

When ignited, creosote creates an extremely hot fire which may damage the chimney or even destroy the house.

The chimney shall be inspected at least annually before lighting, or once every two months during heating season.

When creosote has accumulated it shall be removed to reduce the risk of a chimney fire.

8. Opacity

Opacity indicates how cleanly your fireplace is burning. Opacity is measured in percent; 100% opacity is when an object is totally obscured by the smoke column from a chimney, and 0% opacity means that no smoke column can be seen. Periodically check the opacity and burn your fireplace as nearly smoke-free as possible (goal of 0% opacity).

D. First Fire

Before lighting your first fire in the fireplace, make certain that:

- the baffle and ceramic blanket are correctly positioned, resting against the rear support
- firebrick are in place
- all labels have been removed
- all plated surfaces have been cleaned

NOTICE: Oils can cause permanent markings on plating if not removed before the first fire.

NOTICE: The first three or four fires should be of moderate size to allow the oils and binders to be burned from the fireplace and the refractory and paint to cure. You may notice an industrial odor the first few fires. This is considered normal.

E. Lighting Instructions/Establish Coal Bed

- Open outside air by opening the lower access panel and locate the outside air handle (it could be on the left or right). Lift the handle up and pull out to open. See Figure 3.20.

Note: This may be closed only when the fireplace is not in use to prevent cold air infiltration.

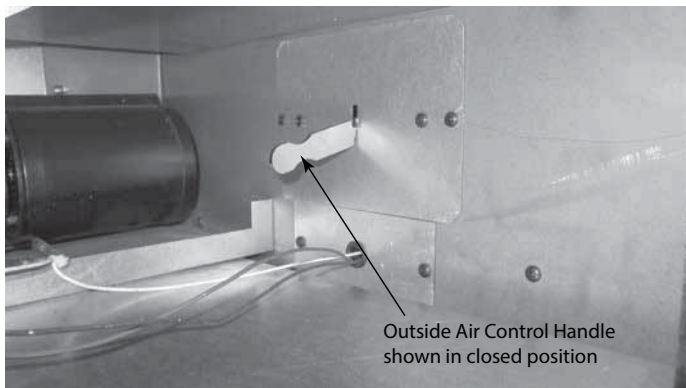

Figure 3.20 Outside Air Handle Shown on Right Side

- Move the combustion air control to the right, you will feel resistance about three-fourths of the way. You must move past that resistance approximately 3/4 in. (19 mm) to fully engage the automatic combustion control (ACC) system.
- Place several wads (3-4 pieces) of crumpled newspaper on the firebox floor. Add 5-6 lbs. of kindling (pieces of dry cord wood less than 1 inch in diameter) stacked on top of the paper crisscrossed. See Figure 3.21.
- Make sure that no matches or other combustibles are in the immediate area of the fireplace. Be sure the room is adequately ventilated and the flue unobstructed.
- For best results, use a hand held homeowner-type gas torch to light the paper and wood for approximately one minute.



Figure 3.21 Placing Kindling

- Leave the door slightly open 2-4 inches (see Figure 3.25) for 2-3 minutes then close the door, latching it lightly to allow the flame to get going good.
- When 1/2 to 2/3 of the kindling burns down, open the door and level the firebox.
- Add 7 to 9 pounds of start-up wood (1-3 inch diameter pieces of cord wood) by stacking them in a crisscross pattern. This will allow for proper air flow.
- Leave door slightly open 2-4 inches (see Figure 3.25) for 1-3 minutes or until a good flame is present. Then close the door, latching it lightly. See Figure 3.26.
- After the flame gets established (approximately 3-5 minutes) shut and latch the door. See Figure 3.27.
- When the start-up has burned down 1/2 to 2/3 and a good flame is still present, open the door. Level the coal bed insuring that the combustion air holes are not blocked.

High Burn

- Load 4-6 pieces of cord wood 22 inches long to achieve maximum firebox volume, stack 2 to 3 pieces high in the back first, then 2 to 3 pieces in the front, making sure to work the bottom pieces into the coal bed to insure solid stack once all the wood is loaded. Leave at least a 1 inch gap between the two stacks to insure good air flow around the wood. See Figures 3.22, 3.23 & 3.24 for examples.
- Leave the door slightly open 2-5 inches (see Figure 3.25) for up to 5 minutes to get a good flame going then close the door. See Figure 3.27.
- When fire has burned down and ready for reloading, level out the coal bed first and reset the ACC if needed.



Figure 3.22 Loading Wood

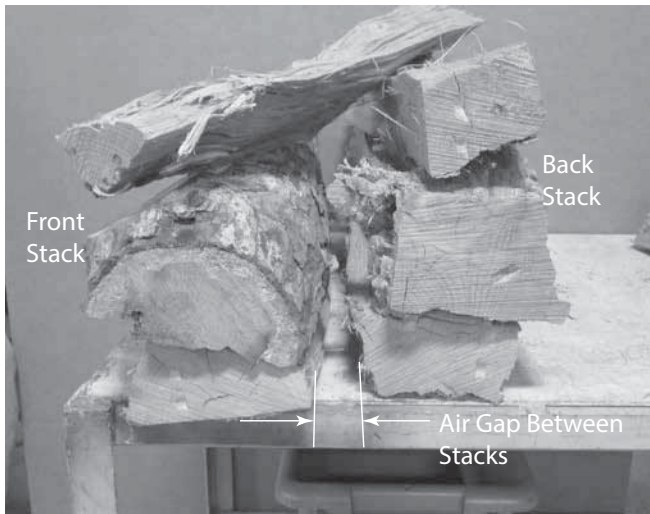

Figure 3.23 Stacking Wood

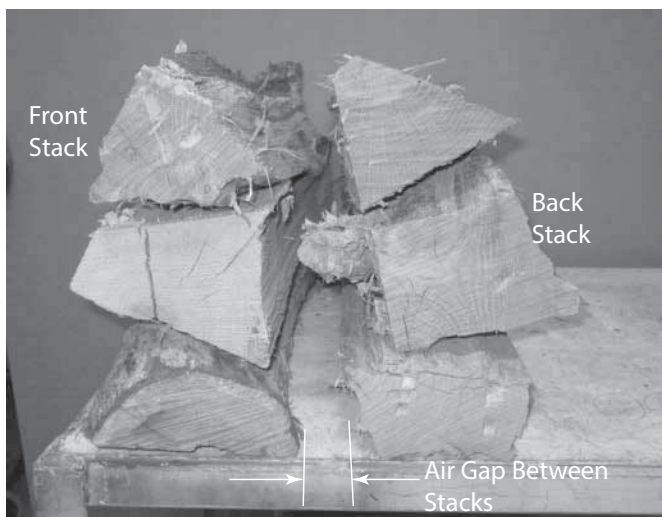

Figure 3.24 Stacking Wood

Medium/Low Burn

- Open the door and load the wood the same as the high burn. Then partially close the door leaving it open around 4-8 inches for up to 5 minutes or until the wood is burning good. Close the door and reset the ACC if needed. Let it burn for up to 20 minutes before setting the combustion air control to the desired setting.

COMBUSTION AIR CONTROL SETTINGS

- LOW - all the way to the left.
- MEDIUM - from the low setting go up to 1/2 inch to the right.
- HIGH - all the way to the right until resistance is felt.

NOTE: The ACC should only need to be activated when starting from a cold start or if a lively coal bed isn't present when reloading.

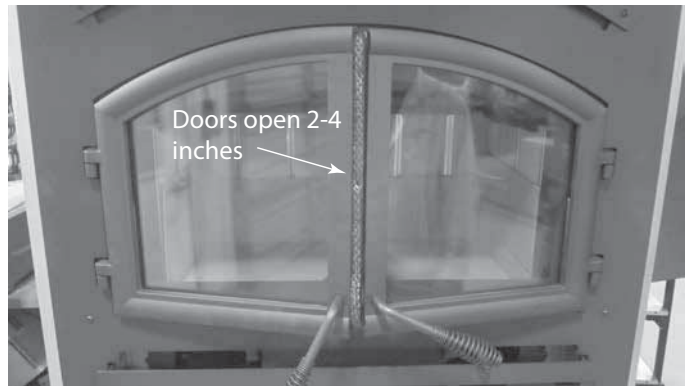

Figure 3.25 Doors Open 2-4 Inches



Figure 3.26 Doors Latched Lightly

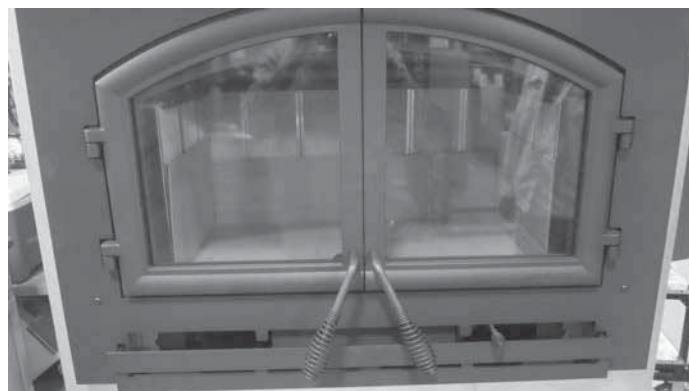

Figure 3.27 Doors Fully Closed

F. Frequently Asked Questions

ISSUES	SOLUTIONS
Odor from appliance	When first operated, this appliance may release an odor for the first several hours. This is caused by the curing of the paint and the burning off of any oils remaining from manufacturing.
Metallic noise	Noise is caused by metal expanding and contracting as it heats up and cools down, similar to the sound produced by a furnace or heating duct. This noise does not affect the operation or longevity of the appliance.
Whirring sound	The fan produces a whirring sound which increases in volume as the speed is increased.

CONTACT YOUR DEALER for additional information regarding operation and troubleshooting.
Visit www.majesticproducts.com to find a dealer.

WARNING

DO NOT PLACE COMBUSTIBLE OBJECTS IN FRONT OF THE APPLIANCE. High temperatures may ignite clothing, furniture or draperies.

WARNING



Fire Risk.

- DO NOT BURN GARBAGE OR FLAMMABLE FLUIDS SUCH AS GASOLINE, NAPHTHA OR ENGINE OIL.

- Do NOT burn treated wood or wood with salt (driftwood).
- May generate carbon monoxide if burn material other than wood.

May result in illness or possible death.

WARNING



Fire Risk.

Keep combustible materials, gasoline and other flammable vapors and liquids clear of appliance.

- Do NOT store flammable materials in the appliance's vicinity.
- DO NOT USE GASOLINE, LANTERN FUEL, KEROSENE, CHARCOAL LIGHTER FLUID OR SIMILAR LIQUIDS TO START OR "FRESHEN UP" A FIRE IN THIS HEATER.
- Keep all such liquids well away from the heater while it is in use.
- Combustible materials may ignite.

NOTE: Home owners are encouraged to provide smoke and carbon monoxide detectors in accordance with the authority having jurisdiction.

4 Maintenance and Service

This fireplace needs periodic inspection and repair for proper operation. It is against federal regulations to operate this fireplace in a manner inconsistent with operating instructions in this manual.

WARNING! Hot Surfaces!

*Glass and other surfaces are hot during operation AND cool down. **DO NOT** clean fireplace until it is cooled.*

Task	Frequency	To be completed by
1. Chimney Inspection	As needed	Homeowner or Chimney Sweep
2. Chimney Cleaning	As needed	Chimney Sweep
3. Plated Surfaces Cleaning	As needed	Homeowner
4. Glass Door	Seasonally	
5. Glass Cleaning	As needed	
6. Door Gasket	Seasonally	
7. Ash Removal	As needed	
8. Baffle/Blanket/Channel Protector	Seasonally	
9. Firebrick	Seasonally	

A. Maintenance Tasks-Homeowners

Installation and repair should be done by a qualified service technician only. The fireplace should be inspected before use and at least annually by a professional service person.

The following tasks may be performed annually by the homeowner. If you are uncomfortable performing any of the listed tasks, please call your dealer for a service appointment.

1. Chimney Inspection

Frequency: As necessary; at least annually before lighting fireplace, or once every two months during heating season.

By: Homeowner/Chimney Sweep

- Confirm that termination cap remains clear and unobstructed.
- Inspect for blockages such as bird nests, leaves, etc.
- Inspect for corrosion or separation.
- Inspect for creosote and remove as needed, at least every two months during the heating season.
- Inspect the system at the fireplace connection and at the chimney top.

Have the chimney and adjacent structure inspected by qualified professionals. Hearth & Home Technologies recommends that NFI or CSIA certified professionals, or technicians under the direction of certified professionals, conduct an inspection of the chimney per the criteria in NFPA 211.

WARNING! Risk of Asphyxiation and Fire! Annual inspection by qualified technician recommended.

Check:

- *condition of door, surrounds and fronts*
- *condition of glass and glass assembly*
- *obstructions of combustion and ventilation air*
- *obstructions of termination cap*

Clean:

- *glass*
- *air passageways, grilles*

2. Creosote (Chimney) Cleaning

Frequency: As needed; at least annually before lighting, or once every two months during heating season. When creosote has accumulated it shall be removed to reduce the risk of a chimney fire.

By: Chimney Sweep

Tools Needed: Brush, Phillips screwdriver

- When wood is burned slowly, it produces tar and other organic vapors, which combine with expelled moisture to form creosote. The creosote vapors condense in the relatively cool chimney flue of a slow-burning fire. As a result, creosote residue accumulates on the flue lining. When ignited, this creosote makes an extremely hot fire.
- Remove all ash from the firebox and extinguish all hot embers before disposal. Allow the fireplace to cool completely.
- Remove baffle and ceramic blanket from fireplace before cleaning chimney (refer to Section 4.B.5 Baffle Removal and Installation).
- Close the door tightly.
- Remove the top of the termination cap as shown in Figure 4.1 to clean the cap and chimney.
- The creosote or soot should be removed from the chimney with a brush specifically designed for the size of chimney in use.
- Reinstall termination cap.
- Clean out fallen debris from the firebox.
- Replace baffle and ceramic blanket.

WARNING! Risk of Fire! Ignited creosote is extremely HOT. Prevent creosote buildup.

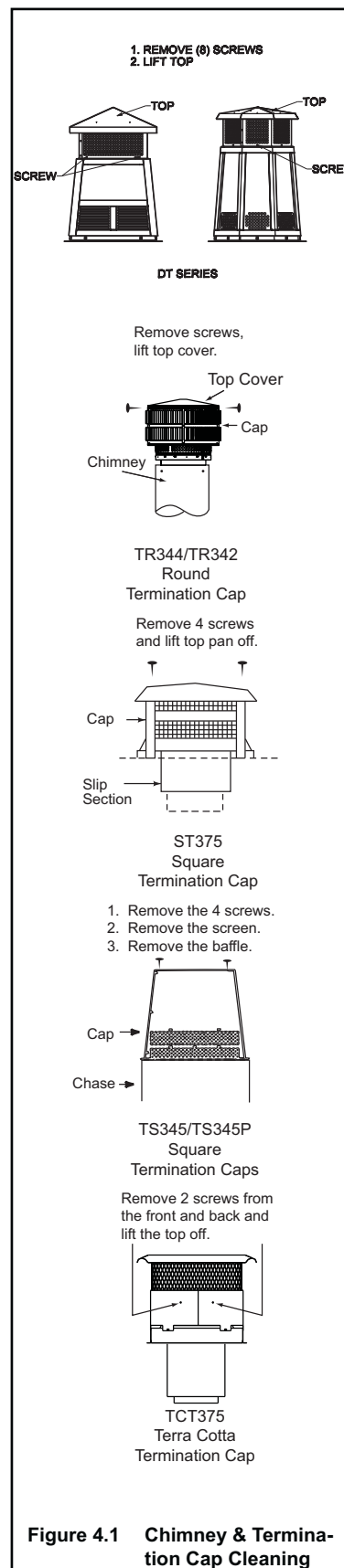

3. Care and Cleaning of Plated Surfaces

Frequency: Initially and as needed

By: Homeowner

Tools Needed: Vinegar or glass cleaner, soft towel

CAUTION! Do not use a polish with abrasives. It will scratch plated surfaces.

- Use a glass cleaner or vinegar and towel to remove the oils.
- Oils can cause permanent markings on plating if not removed.
- After plating is cured, oils will not affect the finish.

4. Glass Doors

Frequency: As necessary

By: Homeowner

- Inspect glass panel for cracks. Replace if this condition is present.
- Inspect glass gasket. Confirm glass does not move around in glass frame.

5. Glass Cleaning

Frequency: As necessary

By: Homeowner

Tools Needed: Vinegar or glass cleaner, soft towel

- Clean glass with a non-abrasive glass cleaner. Use a damp cloth dipped in wood ashes or a commercially available oven cleaner. Remove any oven cleaner residue with a glass cleaner or soap and water.

6. Door Gasket

Frequency: Seasonally

By: Homeowner

- Open door, place half a dollar bill inside and close the door.
- Attempt to pull the bill out.
- If the bill gives good resistance or is not removable, the gasket is adjusted correctly. If the bill is easily removed, the gasket needs adjustment or replacement to create an even seal all around door.

It may be necessary to adjust or tighten the door latch.

7. Ash Removal

Frequency: As necessary

By: Homeowner

Tools Needed: Covered metal container, metal shovel, fireplace broom

WARNING! Risk of Fire! DO NOT remove ashes until the fire is out and the fireplace is cold.

- Ashes should be placed in metal container with tight fitting lid.
- The closed container of ashes should be placed on a noncombustible floor or on the ground, well away from all combustible materials, pending final disposal.
- If the ashes are disposed of by burial in soil or otherwise locally dispersed, they should be retained in the closed container until all cinders have thoroughly cooled.

8. Baffle and Blanket

Frequency: As necessary

By: Homeowner

Tools Needed:

- Ensure correct baffle and baffle protection channel placement; replace baffle components if damaged or missing.
- The ceramic blanket and baffle board **MUST** be in contact with the back of the firebox and even with each other in the front. The baffle protection channel **MUST** be in position. Refer to Section 3.A.3.

9. Firebrick

Frequency:

By:

Tools Needed:

- Inspect condition of brick. Replace if crumbly or otherwise deteriorated, or if cracks exceed 1/4 in. (6 mm).

B. Replacement Maintenance

1. Glass Replacement

- Ensure that the fire is out and the fireplace is cool to the touch.
- Protect a table or counter top with padding or towels.
- Remove door with broken glass from the fireplace by lifting door up and off of the hinges.
- Lay door face down on table or counter making sure handle and handle attachment knob hang over the edge of the table top so door lays flat on the soft surface.
- Remove screws from the top and bottom glass frames (five on each door) using a #2 Phillips Head screwdriver. Set frames aside and retain screws.
HINT: Soak screws in penetrating oil for easy removal.

- Remove the glass and discard.
- Position the new glass with edges evenly overlapping the opening in the front door.
- Replace the glass frames.
- Start screws to secure glass frames to door, keeping them loose for adjusting the glass. Then continue to tighten each screw alternately, a few turns at a time, until the glass panel is tightened snugly. **DO NOT OVERTIGHTEN OR CROSS THREAD SCREWS.**
- Replace the door on the fireplace.
- After the first burn, recheck the tightness of the screws.

2. Tighten or Adjust Door Latch

Remove the lock nut holding latch cam and four spacing washers on the right hand door as shown in Figure 4.2. Move 1-3 spacing washers to the opposite side of cam. Reinstall the cam and tighten locknut. At least one spacing washer and the black washer must be left in place.

OR

Replace the gasket material. Wear or damage to the gasket material can cause air leakage into the firebox resulting in overfiring and loss of efficiency.

A replacement gasket is available from your dealer.

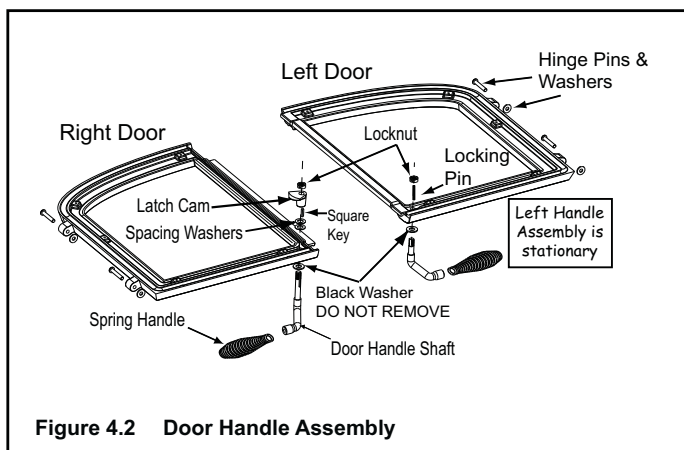
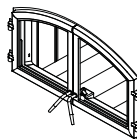

Figure 4.2 Door Handle Assembly

NOTICE: Remove all labels from glass before lighting the first fire in your fireplace.

CAUTION!



Handle glass assembly with care.

When cleaning glass:

- Avoid striking, scratching or slamming glass.
- Do NOT clean glass when hot.
- Do NOT use abrasive cleaners.
- Use a hard water deposit glass cleaner on white film.
- **Refer to maintenance instructions.**



WARNING



Injury Risk.

- Use only glass specified in manual.
- **DO NOT REPLACE** with any other material.

3. Door Handle Assembly

- Slide door handle through door.
- Install washer(s) as shown in Figure 4.3.
- Install key groove.
- Align groove in latch cam with key; slide latch cam over shaft.
- Install locknut but do not overtighten, the handle needs to move smoothly.
- Install spring handle using a clockwise motion until the spring handle is snug against the door handle shaft.

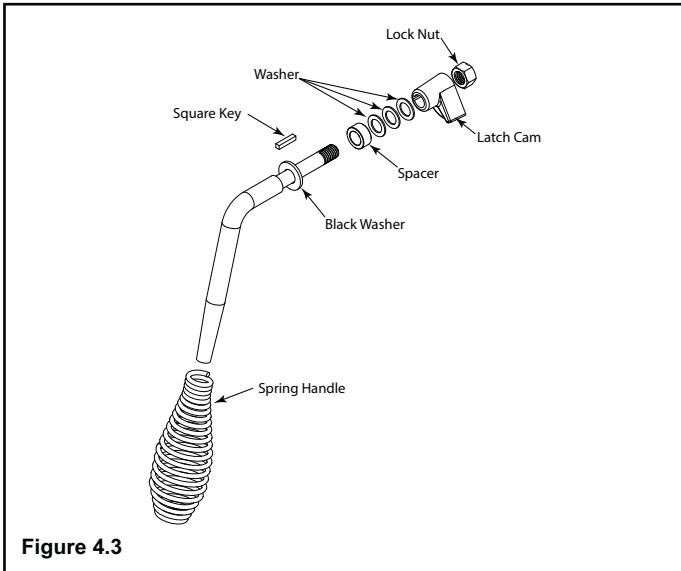

Figure 4.3

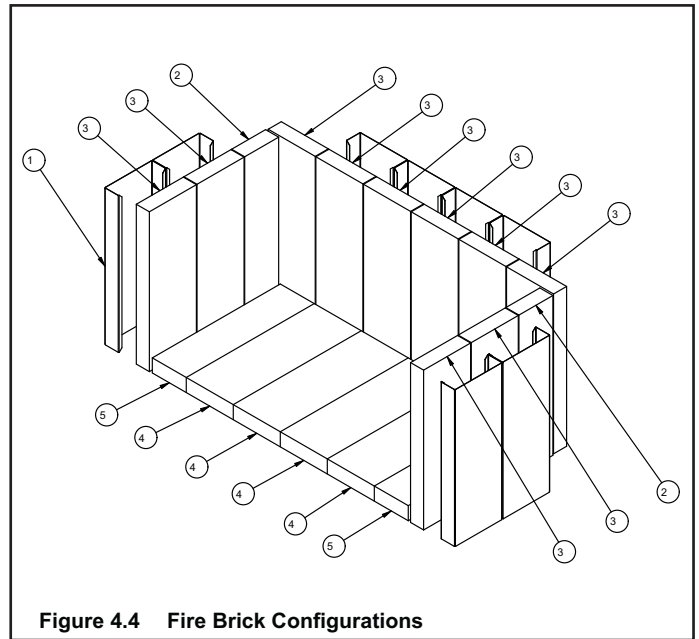

Figure 4.4 Fire Brick Configurations

#	Brick Size	Qty. in Set
1	Brick Wrap	8
2	Firebrick 13.25 x 3.25	2
3	Firebrick 13.25 x 4.50 x 1.25	10
4	Firebrick 12.25 x 4.50	4
5	Firebrick 12.25 x 3.25	2

4. Firebrick Replacement

The firebox of your fireplace is lined with high quality firebrick, which has exceptional insulating properties. Do not use a grate; simply build a fire on the firebox floor. Do not operate the fireplace without bricks.

IMPORTANT: The bricks are very similar in size. Be certain you have the proper brick in the correct location. Measure the brick size for accuracy.

After the coals are completely cooled, remove all old firebrick and ash from unit and vacuum out firebox.

- Remove new brick set from box and lay out to diagram shown in Figure 4.4.
- Install rear bricks on the top of the bottom bricks. Slide top of bricks under clip on back of firebox wall and push bottom of brick back.
- Install side bricks. Slide top of brick under clips on side of firebox and push the bottom of the brick until it is flush with the side of the unit.
- Lay bottom bricks in unit.

5. Baffle Removal and Installation

WARNING! Hot Surfaces!

Glass and other surfaces are hot during operation AND cool down. **DO NOT** clean fireplace until it is cooled.

1. Remove all ash from firebox and place into a metal container.
2. Remove the baffle protection channel by lifting it up and turning it down and pulling it out of the firebox. See Figure 4.5.

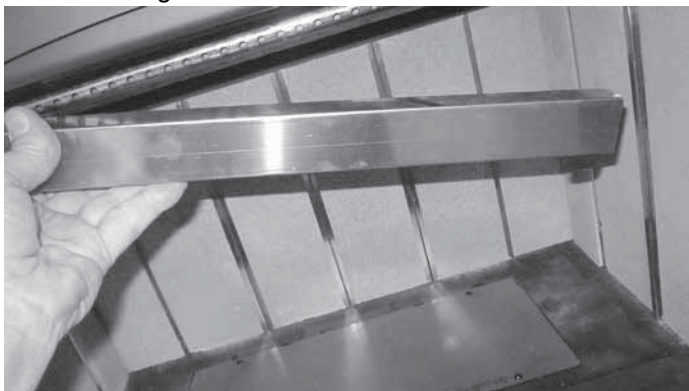

Figure 4.5 Removing Baffle Protection Channel

3. Using a 3/16 inch Allen wrench, remove the front manifold tube retainer bolt on the air channel behind the end of the front tube on the right side. See Figure 4.6.

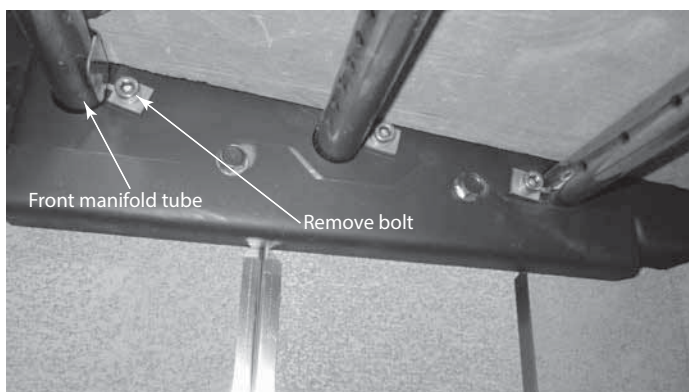

Figure 4.6 Remove Retainer Bolt

4. To remove the manifold tube, slide the tube to one side until one end is out of its hole then pull it down and out of the other hole. It is only necessary to remove the front tube in order to remove the baffle.
5. Pull the two (2) piece baffle board and insulation down and out of the fireplace. See Figure 4.7.

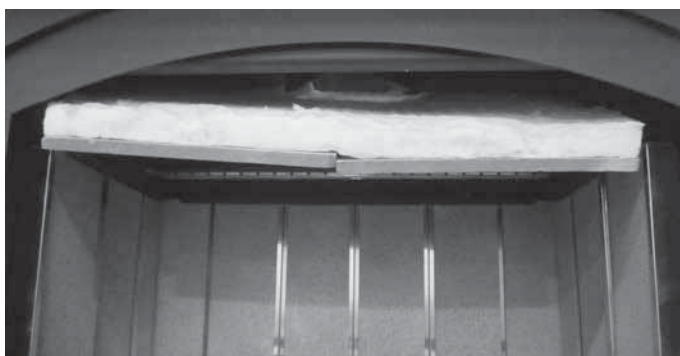

Figure 4.7

6. To install the baffle board and insulation, repeat steps 2 thru 5 in reverse. Be sure the baffle board and insulation are pushed back fully and the insulation is down and flat. See Figures 4.8 & 4.9.

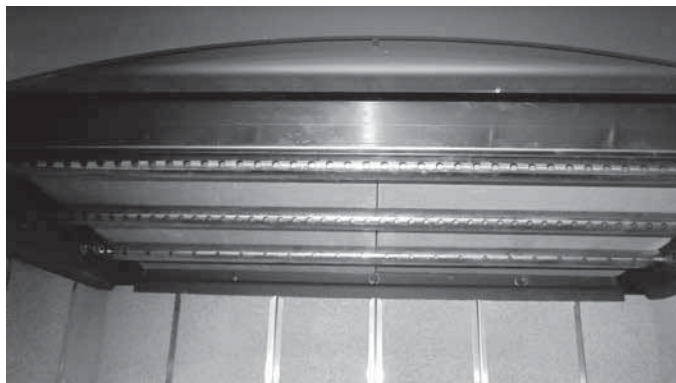

Figure 4.8 Reinstall Baffle Boards

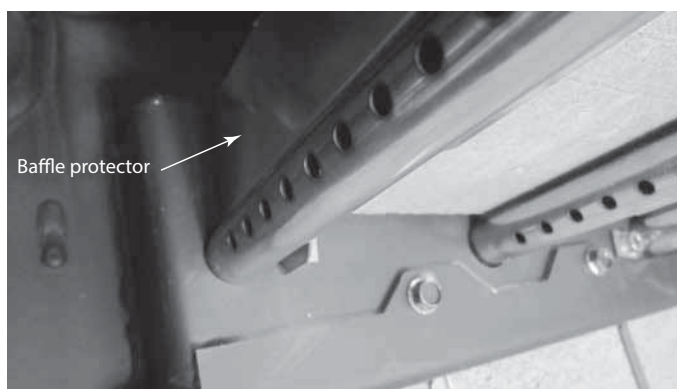

Figure 4.9 Reinstall Baffle Protection Channel

6. Fan Replacement

CAUTION! Risk of Shock! Disconnect power by turning off circuit breaker before servicing or unplugging control board from junction box in behind the access panel..

The Fireplace comes equipped with two fans, installed at the factory with electric access on both sides of the fireplace.

1. Remove the bottom firebrick.
2. Remove the four (4) 5/32 Allen head screws and pry open the access door with a flat blade screwdriver. See Figure 4.10 and remove it.

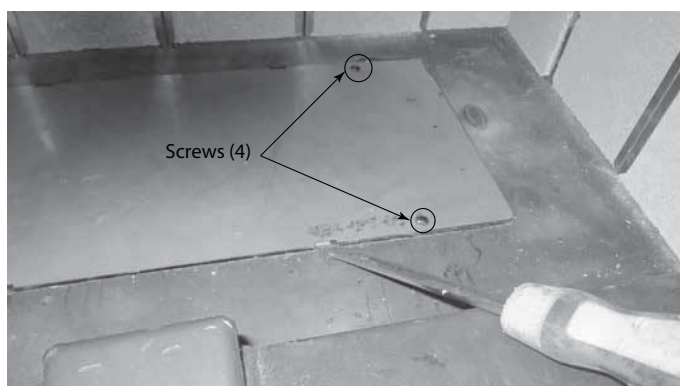

Figure 4.10 Pry Open Access Door

3. While holding the handle, remove the four (4) screws at each corner of the combustion cover and fish it up and out of the bottom of the fireplace. See Figures 4.11 & 4.12.

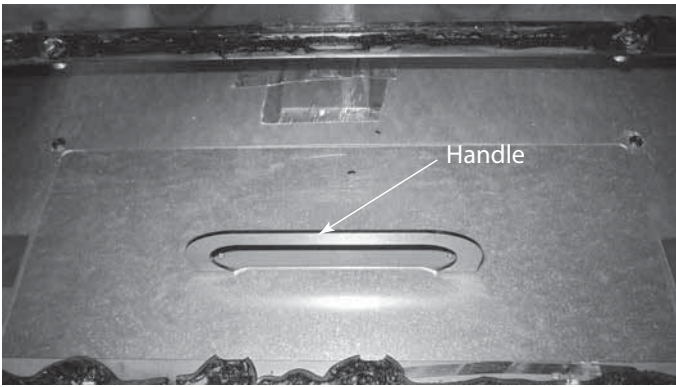

Figure 4.11 Removal of Combustion Cover Screws

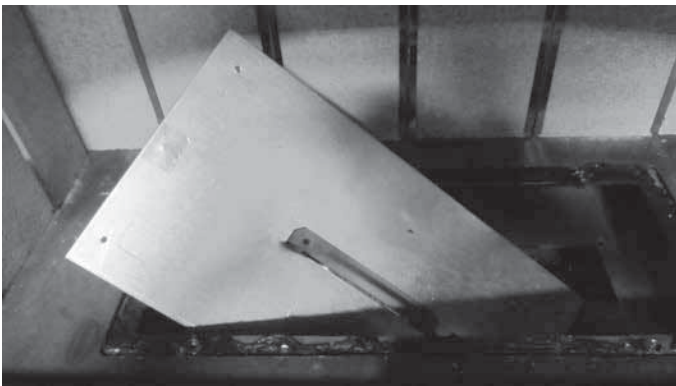

Figure 4.12 Removal of Combustion Cover

4. Unplug the wire harness from the fans and remove the wing nut holding the fan in place. See Figure 4.13.

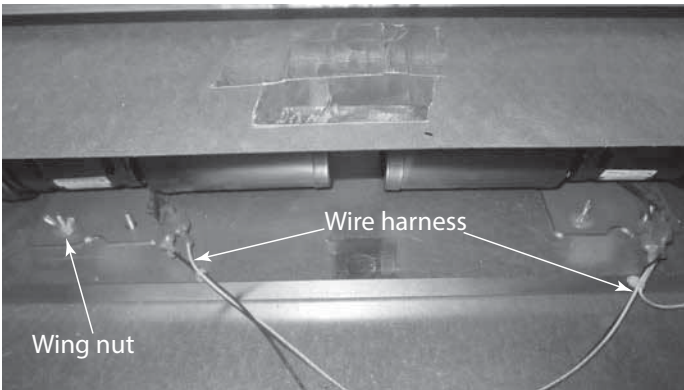

Figure 4.13 Unplug Wire Harness

5. Lift the fan up and off of the locating pins and remove up through the access hole. See Figure 4.14.

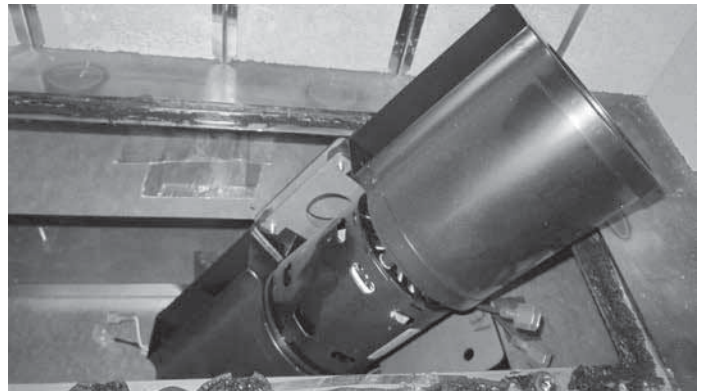

Figure 4.14 Remove Fan from Access Hole

6. Install new fans in reverse order.

7. Timer Assembly Replacement

1. Remove the bottom front access panel by lifting it up and off.
2. Remove the two (2) screws in the air chamber cover. See Figure 4.15. Pull it down and off. See Figure 4.16.

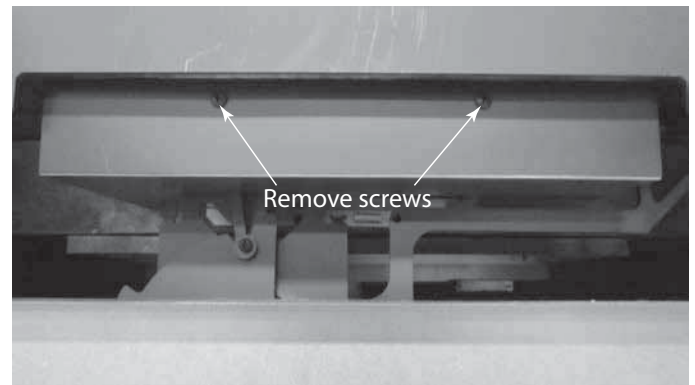

Figure 4.15 Removal of Screws on Air Chamber Cover

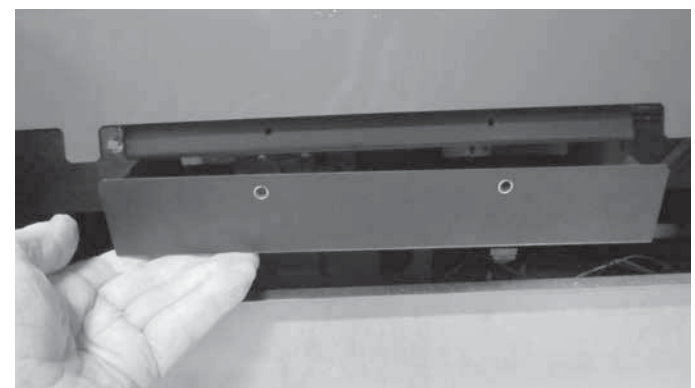

Figure 4.16 Removal of Air Chamber Cover

3. Remove the spring handle by twisting it to the left and pulling on it. Hold on to the rod as this is being done. See Figure 4.17.
4. Pull off and remove the front hairpin clip and washer on the rod. See Figure 4.17.

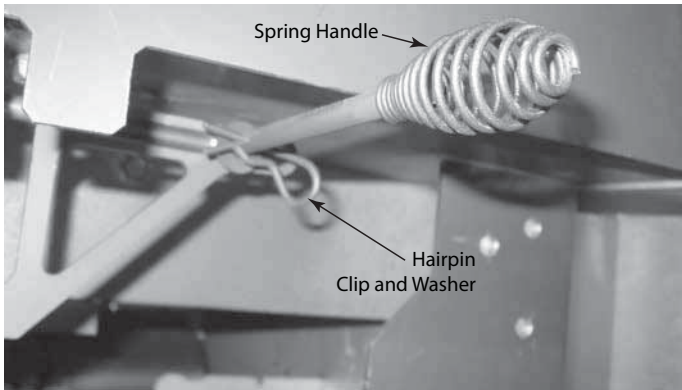

Figure 4.17 Removal of Spring Handle

5. While holding on to the timer assembly, remove the two (2) screws and slide the linkage arm off of the rod and pull the assembly out of the front. See Figure 4.18.

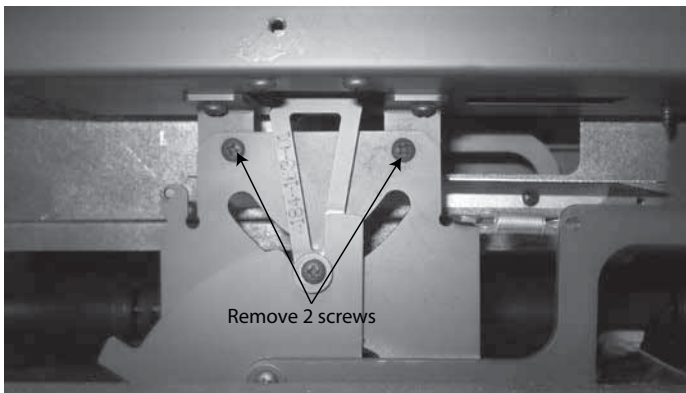

Figure 4.18 Removal of Timer Assembly Screws

6. While supporting the air chamber, remove the two (2) 1/4-20 bolts at each end of it. Then pull it down and out the front. See Figures 4.19 & 4.20.

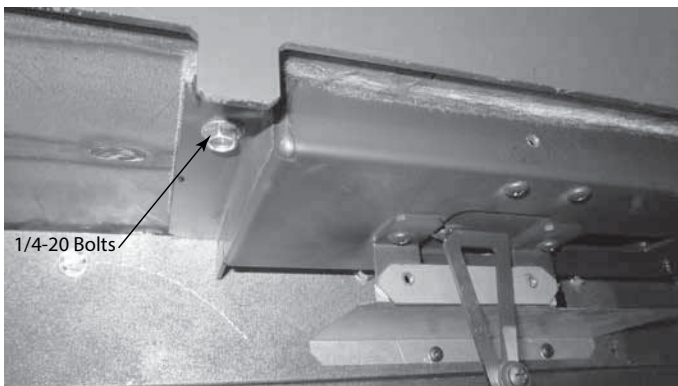

Figure 4.19 Location of Bolts

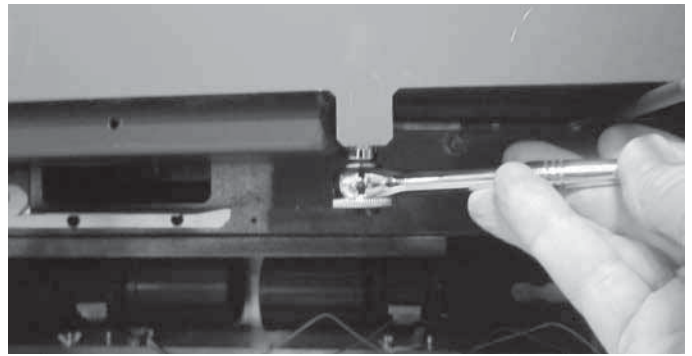

Figure 4.20 Removal of Bolts (2)

7. On the new timer assembly, Figure 4.21, remove the front hairpin clip and washer then two (2) screws disconnecting the air chamber before installation. See Figure 4.22.

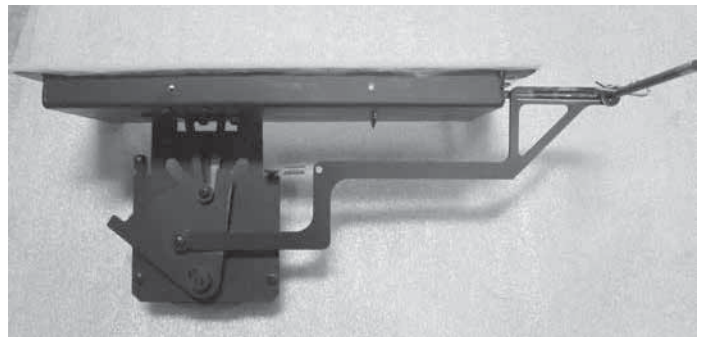

Figure 4.21 Timer Assembly

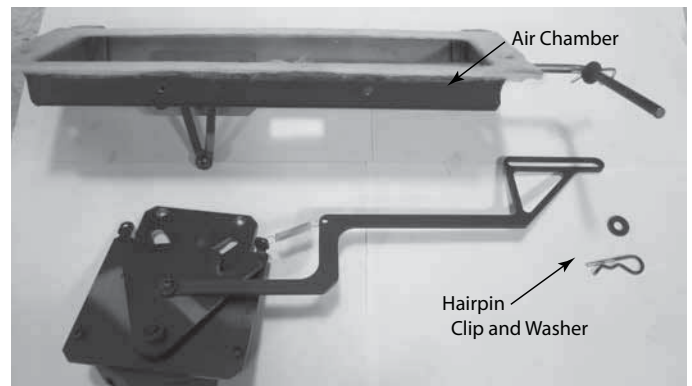

Figure 4.22 Removal of Hairpin Clip, Washer and Air Chamber

8. Install the new air chamber using the 1/4-20 bolts making sure the gasket is installed also. See Figure 4.22.

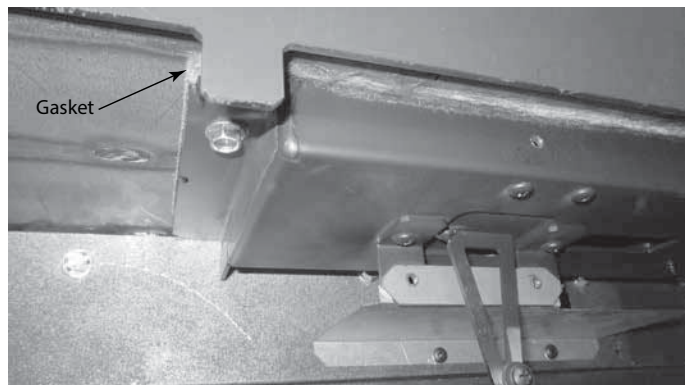

Figure 4.22 Install New Air Chamber

9. Install the timer/linkage by inserting the timer in first and slipping the linkage over the rod. See Figure 4.23.

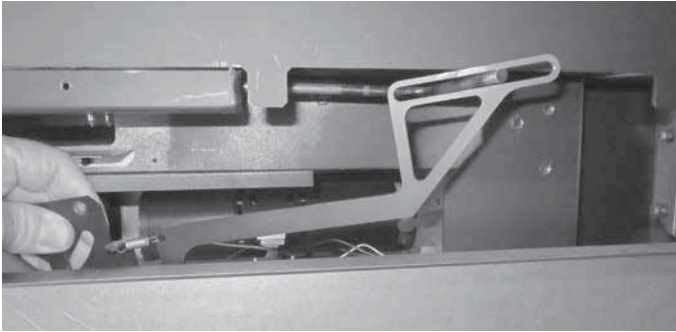

Figure 4.23 Inserting Timer Assembly

10. Screw the timer to the air chamber. See Figure 4.24.

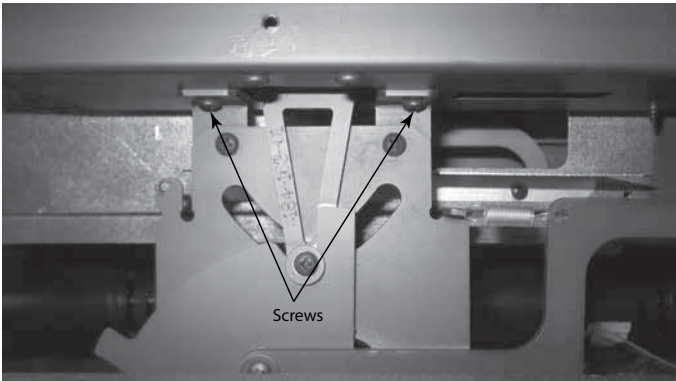

Figure 4.24 Screwing Timer to Air Chamber

11. Install the washer and hairpin clip back on the rod. See Figure 4.25.

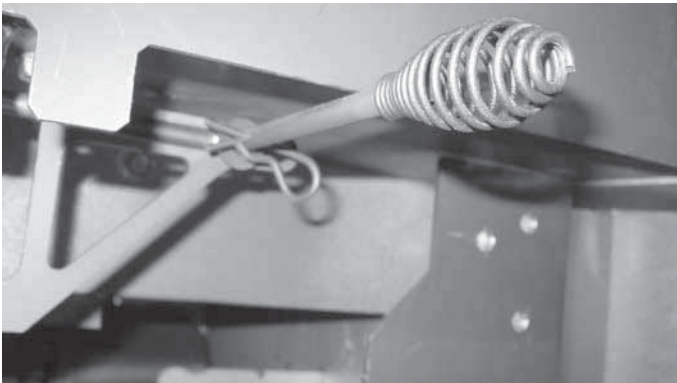

Figure 4.25 Reinstalling Hairpin Clip and Washer

12. Reinstall air chamber cover. See Figure 4.26.
13. Reinstall the bottom front access panel.
14. Reinstall the spring handle by twisting it to the left and pushing it on.

8. Timer Removal & Replacement

1. Remove the bottom front access panel by lifting it up and off.
2. Remove the two (2) screws in the cover. See Figure 4.26 and pull it down and off. See Figure 4.27.

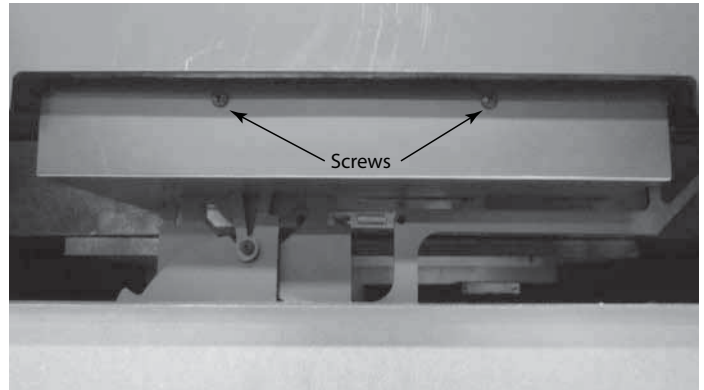

Figure 4.26 Air Chamber Cover

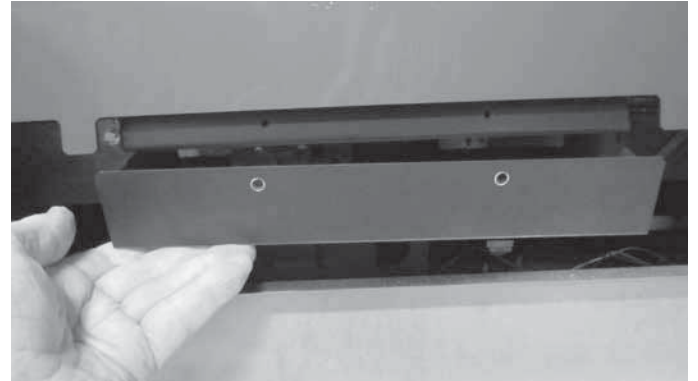

Figure 4.27 Removal of Air Chamber Cover

3. Remove the spring handle by twisting it to the left and pulling on it. Hold on to the rod as this is being done. See Figure 4.28.
4. Pull off and remove the hairpin clip and the washer on the rod. See Figure 4.28.

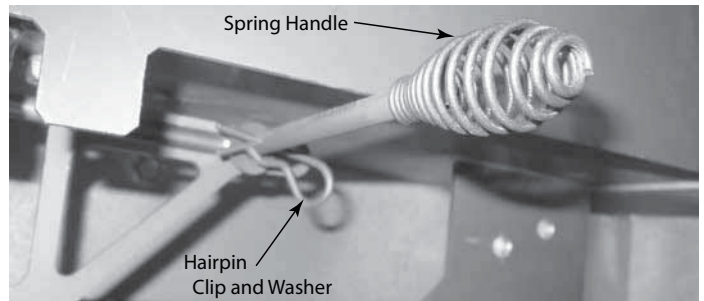

Figure 4.28 Removal of Spring Handle

5. While holding on to the timer assembly, remove the two (2) screws, Figure 4.29 and slide the linkage arm off of the rod and pull the assembly out of the front.

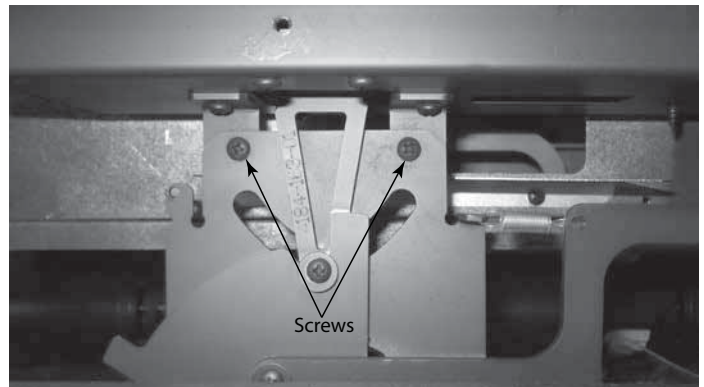

Figure 4.29 Removal of Screws

- Remove the linkage arm and the spring from the timer. See Figure 4.30.

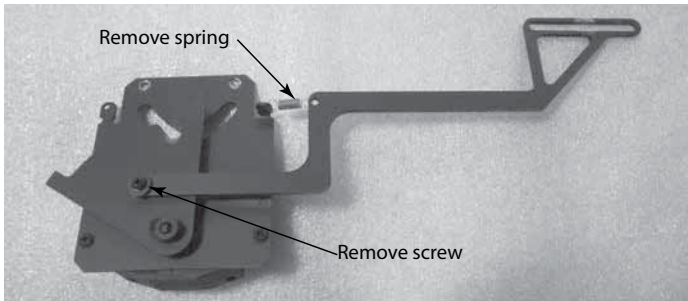

Figure 4.30 Removal of Linkage Arm and Spring

- Loosen set screw on timer, remove two screws and remove timer. See Figure 4.31.

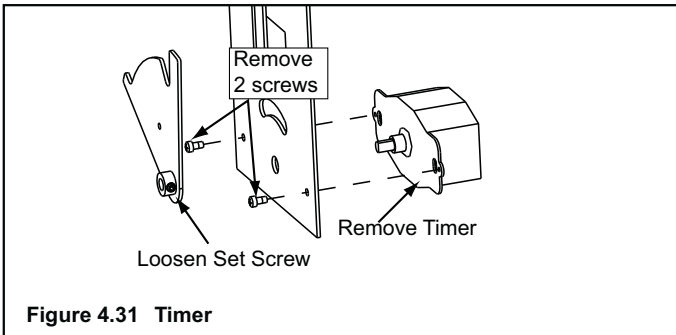

Figure 4.31 Timer

- Install new timer using same two screws. It is very important that the D cut side of the timer shaft is facing the opposite side of the linkage timer arm. See Figure 4.32.

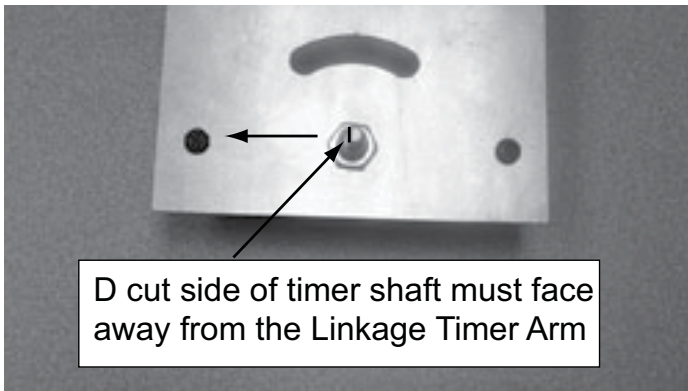

Figure 4.32 D Cut on Shaft

- Place linkage control arm over timer shaft and tighten set screw, Figure 4.33.

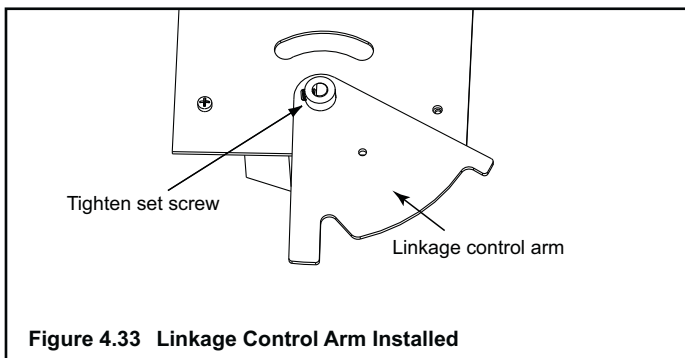

Figure 4.33 Linkage Control Arm Installed

- Rotate linkage control arm into final position. Note that the D cut is now facing the linkage timer arm. Re-attach the linkage timer arm and spring. See Figure 4.34.

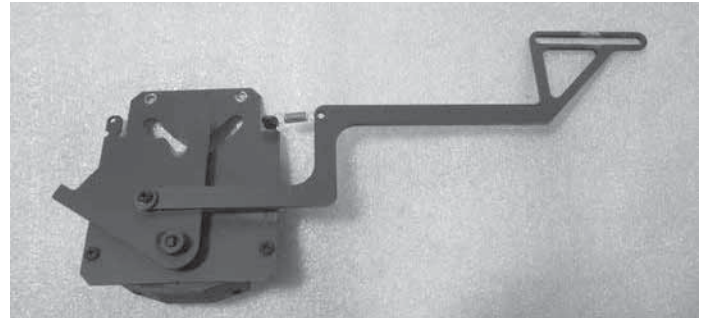

Figure 4.34 Reattach the Linkage Timer Arm

- Install the timer/leakage by inserting the timer in first and slipping the linkage over the rod. See Figure 4.34.

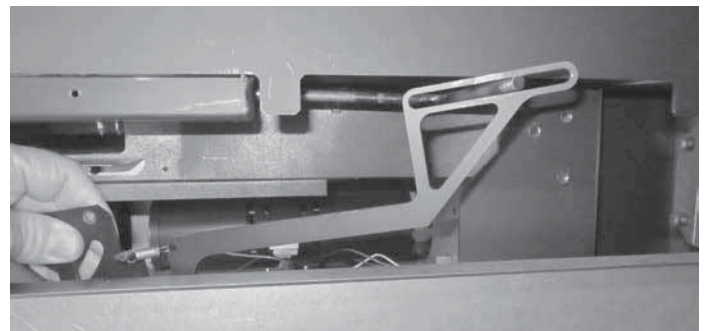

Figure 4.34 Insert the Timer/Leakage

- Screw the timer to the air chamber. See Figure 4.35.

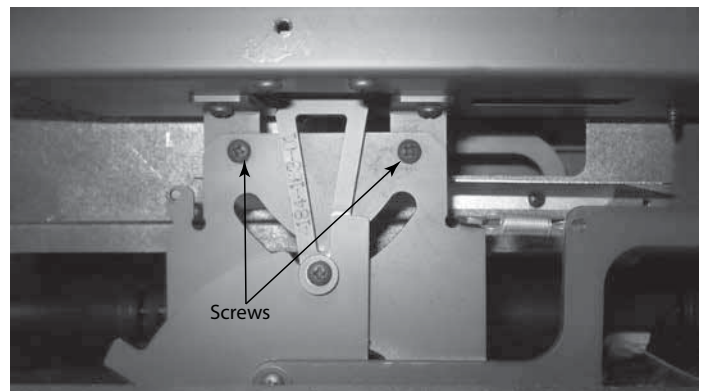

Figure 4.35 Screw Timer to Air Chamber

13. Install the washer and the hairpin clip back on the rod. See Figure 4.36.

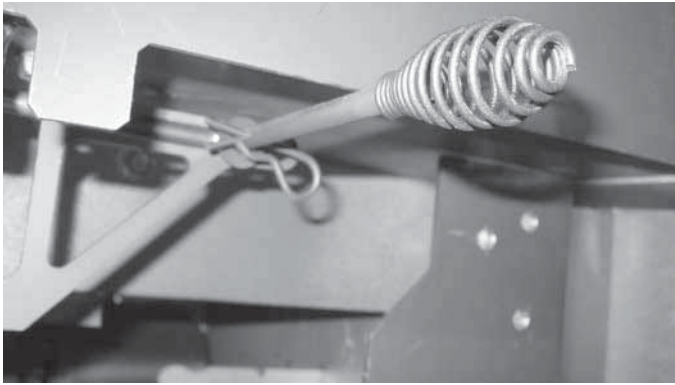

Figure 4.36 Reinstalling Hairpin Clip and Washer

14. Reinstall the air chamber cover. See Figure 4.37.

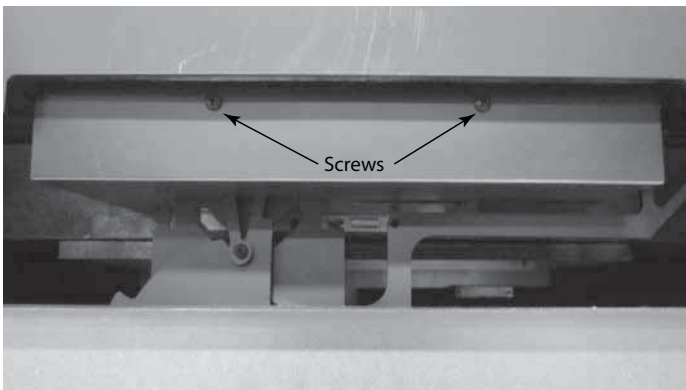

Figure 4.37 Air Chamber Cover

15. Reinstall the bottom front access panel.
16. Reinstall the spring handle by twisting it to the left and pushing it on.

9. Fan Snap Disc Replacement

1. Remove the bottom front access panel by lifting it up and off.
2. Locate the snap disc to the left of the timer assembly.
3. Remove the wires from the snap disc.
4. Remove the 1/4" bolt using a 3/8" socket along with the bracket.
5. Pull the snap disc out of the bracket.
6. Install the new snap disc in the bracket and reinstall in the fireplace. See Figure 4.38.

NOTE: Remember to reattach the wires.

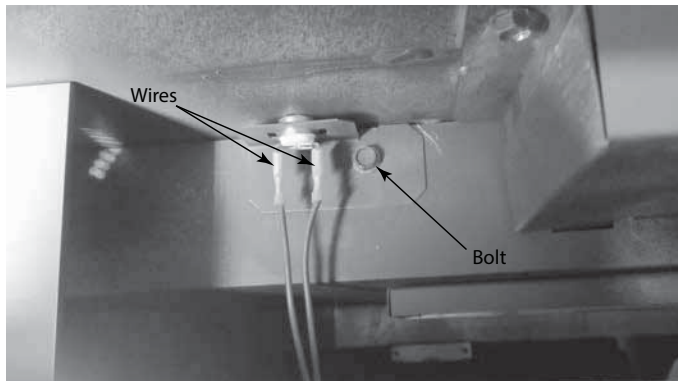

Figure 4.38 Snap Disc Replacement

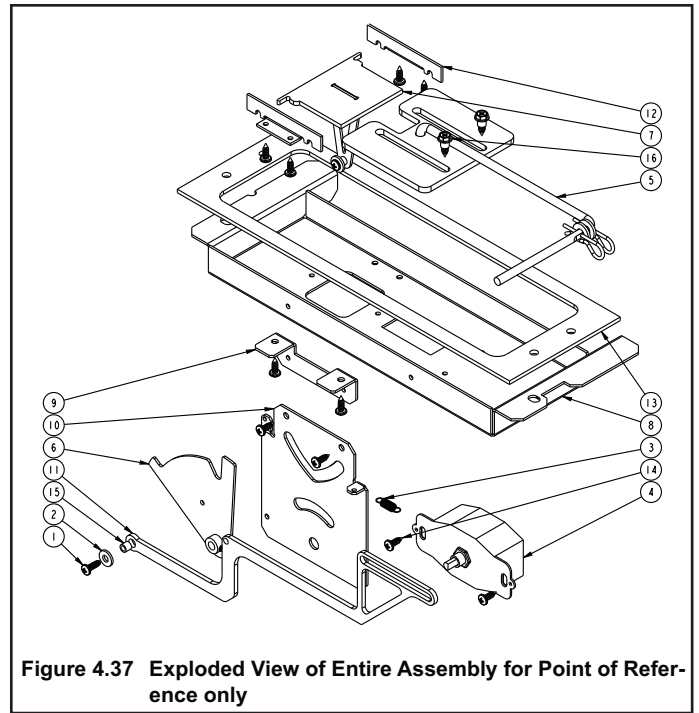

Figure 4.37 Exploded View of Entire Assembly for Point of Reference only

Item	Description	Qty
1	Screw 8-32 x 1/2 PPH BK	1
2	Washer #10 SAE ZN	1
3	Extension Spring	1
4	Timer Mechanical 12 HR	1
5	Slide Assembly	1
6	Timer Arm Assembly	1
7	Timer Door Assembly	1
8	Air Channel Bottom	1
9	Timer Bracket	1
10	Timer Base	1
11	Timer Handle	1
12	Timer Door Retainer	2
13	Air Channel Gasket	1
14	Screw 8 x 12 PPH BK	10
15	Spacer #8 1/4D 7/32L ZN	1
16	HHSS #10 x 1/4D 1/4 L BK	2

5 Troubleshooting

A. FAQs

Hearth & Home Technologies assumes no responsibility for the improper performance of the fireplace system caused by inadequate draft due to environmental conditions, down drafts, tight sealing construction of the structure, or mechanical exhausting devices which will create a negative air pressure within the structure where the fireplace is located.

If smoke spillage occurs from a fireplace opening when the door is open, there is either a leakage in the flue, a blockage in the flue, or some condition is affecting draft. Understanding and differentiating the conditions which can cause each of these kinds of spillage problems is essential to their solution.

- **Flue Leakage**
Check for improperly connected flue joints or a damaged flue joint in the chimney system. Such leakage would reduce draft (air would be drawn in through the leaks rather than through the fireplace). The result might be difficult start-up and smoky fires that might spill if other adverse draft conditions accompany this problem.
- **Flue Blockage**
The damper should be open.
Check for objects that may have fallen down the chimney.

Flue draft is measured as negative pressure in the chimney. The amount of negative pressure determines how strong the draft is. The draft is important because it draws the combustion air into the fireplace and pulls the smoke out of the chimney.

There are three basic criteria essential in establishing and maintaining flue draft:

- availability of combustion air
- heat generated from the fire
- diameter and height of the flue system

These three factors work together as a system to create the flue draft. Increasing or decreasing any one of them will affect the other two and thus change the amount of draft in the entire system.

If the fire is hard to start and smoke spills out of the fireplace, or you find it difficult to establish and maintain a moderately high burn rate, then the flue draft is too low and corrective measures must be taken.

Be sure you have air available for combustion and that your firewood is dry and well seasoned. Build your fires properly and according to the instructions given in op-

erating instructions, "Starting a Fire". Be sure your flue system is installed correctly and that it is the proper diameter and height. Check for the following:

- All chimney sections are properly installed.
- The chimney is clean and free of creosote or soot buildup.
- Make sure overhanging trees and branches are cut back within ten feet of the top of the chimney and the chimney is free of debris from animals.
- Ensure the chimney cap is clean and free of any buildup of soot or creosote if cap is equipped with a spark arrestor screen.
- Be sure the ceramic blanket (above the baffle) and the baffle are in their proper positions
- The wood being used is dry and well seasoned.

If you still suspect you have a low draft problem it may be necessary to increase the volume of air in your flue system. Since the diameter of your flue system is matched with the size of the flue collar and should not be changed, then the height of the system must be increased. Add chimney sections one at a time until the draft improves.

In some cases, regardless of what you do, it can still be difficult to establish the proper flue draft. This is especially evident when using an exterior factory-built chimney or exterior masonry chimney. Try holding a burning rolled up newspaper as close to the flue outlet as possible for a few minutes, then light the paper under the kindling. The heat generated from the burning rolled up newspaper should help get the draft established.

Still other factors can affect how well your flue system performs. Neighboring structures, high winds, tall trees, even hillsides can affect air currents around the chimney. Well designed chimney caps are available that can help. Your fireplace dealer is the local expert in your area. He can usually make suggestions or discover problems that can be easily corrected allowing your fireplace to operate correctly as it has been designed, providing safe and economical heat for your home.

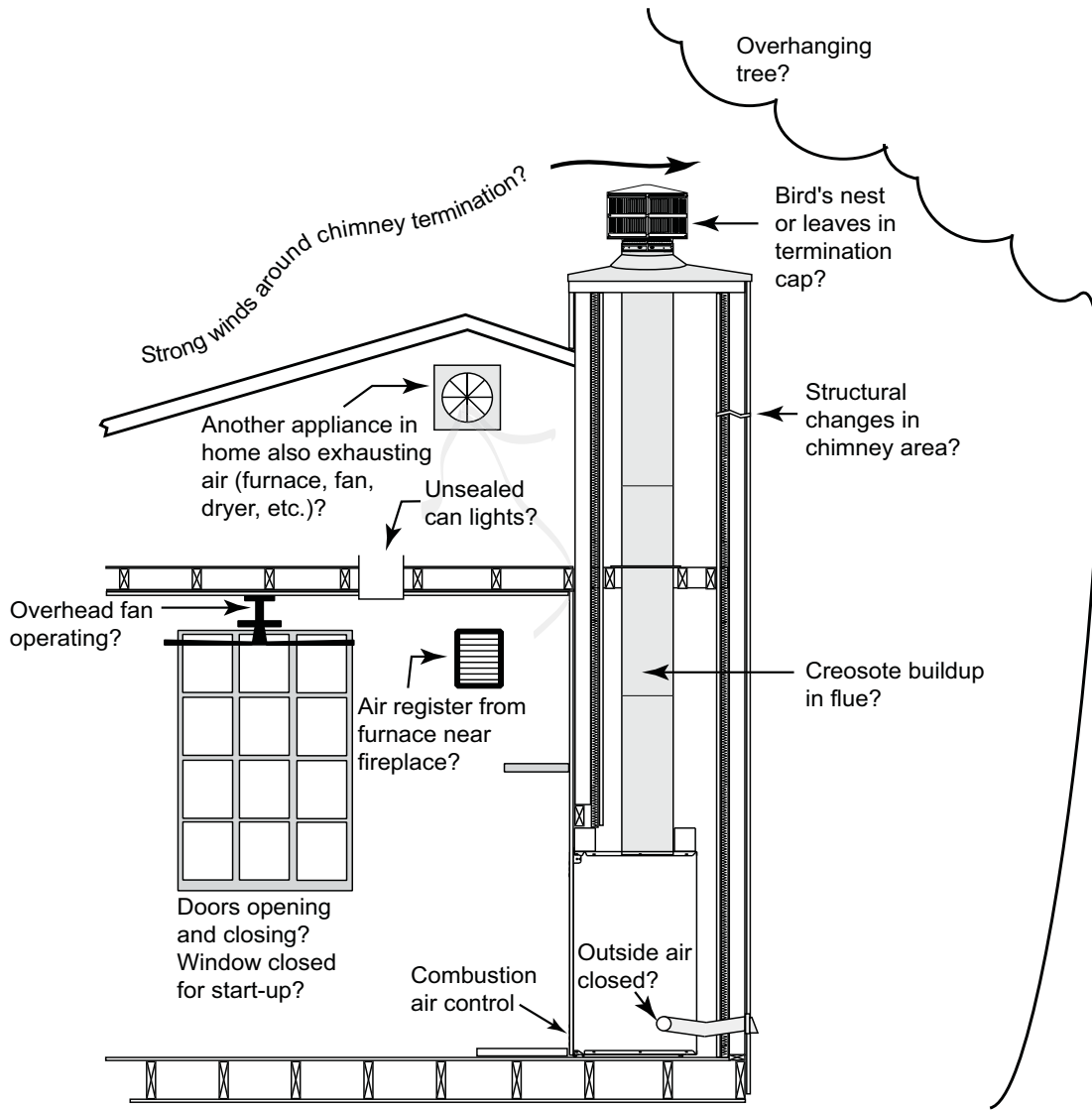

Figure 5.1 Factory-built Fireplaces: Troubleshooting

B. Troubleshooting Table

Fire is difficult to start	• Refer to section 3.E. Lighting Instructions
	• Open air controls
	• Establish draft: Hold a lighted, rolled up newspaper under the front of the baffle
	• Place DRY kindling over wadded up newspaper; leave air spaces between pieces of wood
	• Light the paper, allow kindling to ignite and progress to a lively burn
	• Slowly add progressively larger pieces of dry wood until the fire is well established
Smoke in the house at startup	• Check and clean chimney if needed
	• Open air controls
	• Establish draft
	• Do not use exhaust fans during startup
	• Do not close doors until the fire is well-established
Smoke in the house during operation	• Check and clean chimney if needed
	• Check door rope for seal
	• Open air controls (ACC)
Smoke in the house during refueling	• Open air controls (ACC) to establish a lively coal bed
	• Open doors SLOWLY
	• Add progressively larger wood to establish a hot fire
Fuel burns too fast	• ACC not working properly
	• Wood too dry, mix in less seasoned wood after the fire is established
	• User larger diameter wood
	• Check baffle/ceramic blanket for proper placement (Section 3.A.3)
	• Close down ACC (refer to section 3.B.)
Glass doesn't stay clean	• Establish a good, hot fire
	• Use well-seasoned wood
Not enough or no heat	• Move combustion air control to fully open position
	• Fan is not on
	• Insufficient fuel for fire/heat required
Fan doesn't come on	• No power
	• Fireplace is not hot enough to activate snap disc
	• Snap disc may be faulty

6 Reference Materials

► A. Service Parts



Service Parts

Woodburning Fireplace

WARMMAJIC-II

Beginning Manufacturing Date: Dec 2019
Ending Manufacturing Date: Active

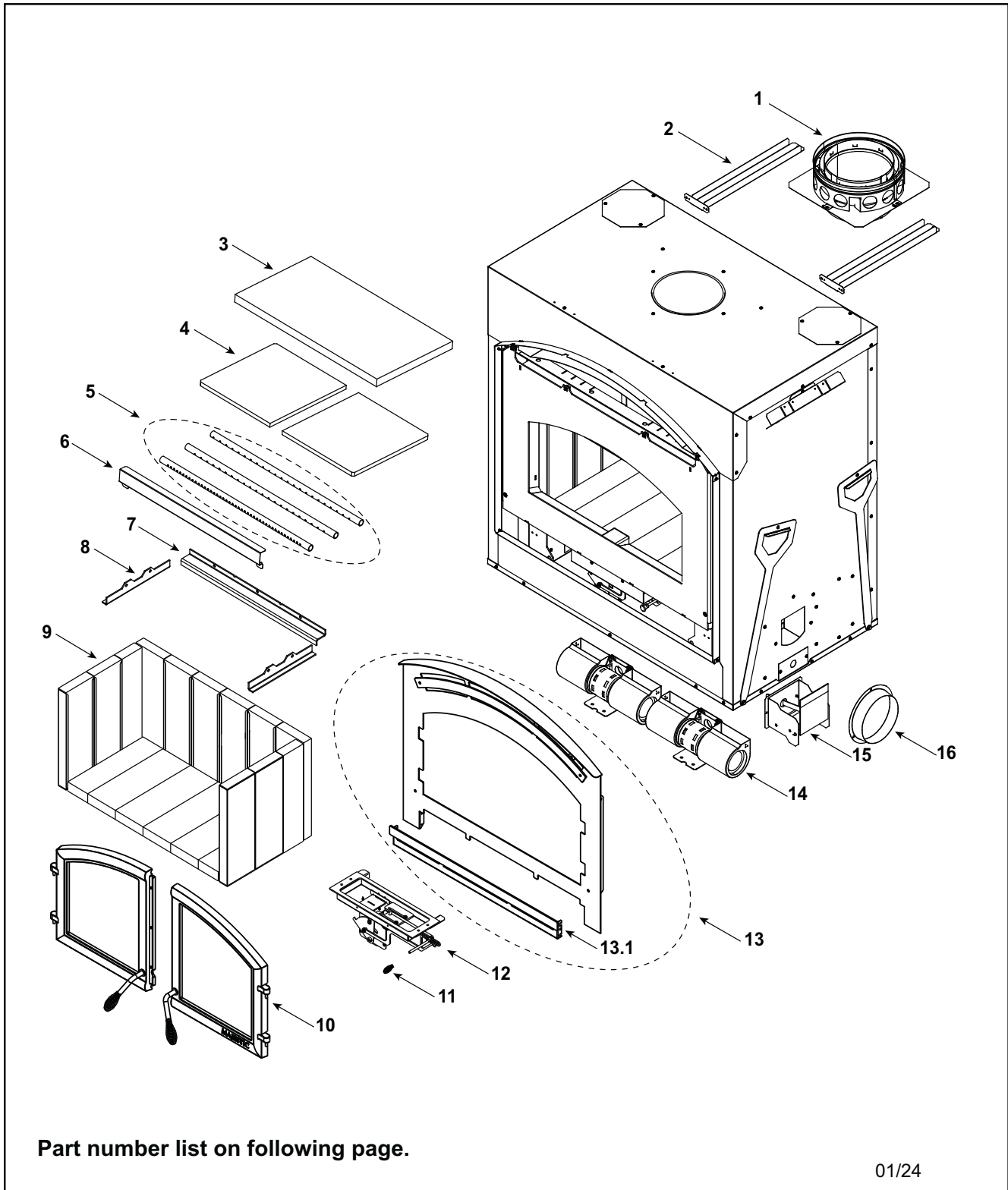

01/24



Service Parts

WARMMAJIC-II

Beginning Manufacturing Date: Dec 2019
Ending Manufacturing Date: Active

IMPORTANT: THIS IS DATED INFORMATION. Parts must be ordered from a dealer or distributor. **Hearth and Home Technologies does not sell directly to consumers.** Provide model number and serial number when requesting service parts from your dealer or distributor.



Stocked at Depot

ITEM	DESCRIPTION	COMMENTS	PART NUMBER	
1	Starter Plate Assembly		SL1	
	Starter Section		SRV22069	Y
2	Standoff, Front	Qty 2 req	SRV4182-233	
3	Baffle Blanket		SRV4184-205	
4	Baffle	Qty 2 req	SRV4184-113	
5	Manifold Tube Set		TUBES-4184	Y
6	Baffle Protector		SRV4184-195	
7	Brick Retainer, Back		SRV4184-123	
8	Brick Retainer, Side	Qty 2 req	SRV4184-121	

#9 Brick Set

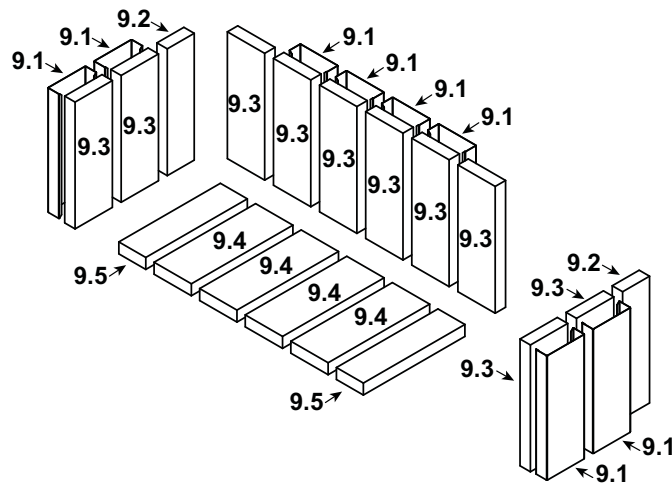

9	Brick Assembly		SRV4184-016	Y
9.1	Brick Wrap	Qty 8 req	SRV4182-101	
9.2	Firebrick, 13.25 x 3.25	Qty 2 req	SRV4182-203	
9.3	Firebrick, 13.25 x 4.5 x 1.25	Qty 10 req	SRV4182-301	
9.4	Firebrick, 12.25 x 4.5	Qty 4 req	SRV4184-201	
9.5	Firebrick, 12.25 x 3.25	Qty 2 req	SRV4184-203	
10	Door Assembly		See following pages	
11	Handle, Spring 1/4 Black		SRV7000-614	Y
12	Timer Assembly		See following pages	
13	Front Assembly (Complete)		SRV4188-070	
13.1	Front Access Grille Assembly		SRV4188-076	
14	Blower Assembly	Qty 2 req	SRV433-5890	Y
	Fan Speed Control		SRV7000-143	
	Wire Harness		SRV480-0990	Y
	Snap Disc, F180F-30		SRV4021-827	

Additional service part numbers on following page.



Service Parts

WARMMAJIC-II

Beginning Manufacturing Date: Dec 2019
Ending Manufacturing Date: Active

IMPORTANT: THIS IS DATED INFORMATION. Parts must be ordered from a dealer or distributor. **Hearth and Home Technologies does not sell directly to consumers.** Provide model number and serial number when requesting service parts from your dealer or distributor.



Stocked at Depot

ITEM	DESCRIPTION	COMMENTS	PART NUMBER
15	Outside Air Assembly		SRV4184-039
16	Unit Collar		SRV4087-314

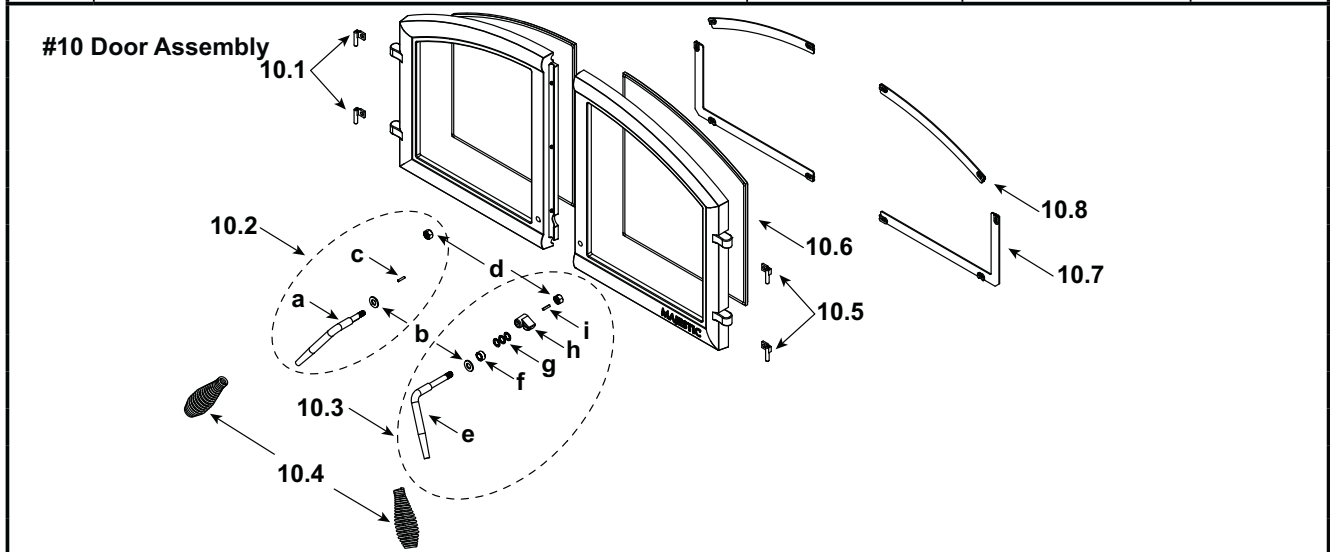

10	Door Assembly		SRV4188-030	
10.1	Door Hing Pin, Left (Pkg of 4)	Qty 2 req	480-2120/4	Y
10.2	Door Handle Assembly, Left		SRV4180-052	
10.3	Door Handle Assembly, Right		SRV4180-051	
a	Door Handle, Left		SRV480-0530	
b	Washer, 3/8 SAE Black	Qty 2 req	832-0990	Y
c	Pin, 1/8 x 5/8 Dowel		SRV7000-163	
d	Nut, 3/8-16 Lock (Pkg of 24)	Qty 2 req	226-0100/24	Y
e	Door Handle, Right		SRV480-0520	
f	Bushing, SLP15		20666A/5	Y
g	Washer, 3/8 MIL SS	Qty 3 req	7000-116/10	Y
h	Cam Latch		SRV4188-200	
i	Latch, Key Cam		SRV430-1151	
	Door Gasketing, 1/2 in. (Right 49.63"/Left 60.88")		SRV433DRGASKET	Y
	Gasket, Lytherm, 1/2" x 1/8"	7 Ft	834-2590	
10.4	Spring Handle, 1/2 Black	Qty 2 req	SRV7000-613	Y
10.5	Door Hing Pin, Right (Pkg of 4)	Qty 2 req	480-2110/4	Y
10.6	Glass Assembly	Qty 2 req	SRV480-5430	Y
	Gasket, 10 Ft Rope		834-4170	Y
10.7	Glass Frame Bottom	Pkg of 2	SRV480-1450	
10.8	Glass Frame Top	Qty 2 req	SRV480-1440	

Additional service part numbers on following page.



Service Parts

WARMMAJIC-II

Beginning Manufacturing Date: Dec 2019

Ending Manufacturing Date: Active

IMPORTANT: THIS IS DATED INFORMATION. Parts must be ordered from a dealer or distributor. **Hearth and Home Technologies does not sell directly to consumers.** Provide model number and serial number when requesting service parts from your dealer or distributor.



**Stocked
at Depot**

ITEM	DESCRIPTION	COMMENTS	PART NUMBER	
<p>#12 Timer Assembly</p>				
12	Timer Assembly (Complete)		SRV4184-044	
12.1	Slide Assembly		SRV4184-041	
12.2	Air Channel Gasket		SRV4184-189	Y
12.3	Extension Spring		SRV433-3950	
12.4	Timer Mechanical, 12 Hour		SRV480-1940	Y
	Combustion Cover Gasket		SRV4184-359	
	Outside Air Hood Assembly		4059-051	
	Chimney Air Kit		CAK4A	
	Fastener Pack, Chimney Air Kit		13580	
	Face Board Assembly, Non-combustible board		SRV4184-064	
	Hearth Strip		SRV18320	
	Template		HHT-TEMPLATE-C	
	Touch Up Paint	Black	812-0910	
Fastener Packs				
	AVK Repair Kit 1/4-20		RIVNUT-REPAIR	Y
	Nut, 1/4-20	Pkg of 4	SRV221-0110	
	Screw, HWH MS 1/4-20 x 3/4	Pkg of 25	220-0080/25	Y
	Screw, PH 8-32 x 1/2	Pkg of 25	220-0030/25	Y
	Washer, 1/4 SAE (for door)	Pkg of 24	28758/24	Y

This page intentionally left blank.

B. Contact Information



Majestic, a brand of Hearth & Home Technologies
1915 West Saunders Street
Mount Pleasant, Iowa 52641

Please contact your Majestic dealer with any questions or concerns.

For the number of your nearest Majestic dealer, please visit www.majesticproducts.com.

– NOTES –

CAUTION



DO NOT DISCARD THIS MANUAL

- Important operating and maintenance instructions included.

- Read, understand and follow these instructions for safe installation and operation.

- Leave this manual with party responsible for use and operation.



This product may be covered by one or more of the following patents: (United States) 6601579, 6769426, 6863064, 7077122, 7074035, 7098269, 7234932, 7258116, 7322819, 7422011, 7470729, 7726300, 8147240, 9625149 or other U.S. and foreign patents pending.

2000-945E