

Englander®

INSTALLATION & OPERATION MANUAL

25-CAB80
55-SHPCAB80
55-TRPCAB80
25-CAB80S
55-SHPCAB80S
55-TRPCAB80S



www.englander-stoves.com

Support: (877) 356-6663

Email: tech@sbi-international.com

CAUTION

PLEASE READ THIS ENTIRE MANUAL BEFORE INSTALLATION AND USE OF THIS PELLET FUEL-BURNING APPLIANCE. KEEP CHILDREN, FURNITURE, AND ALL COMBUSTIBLES AWAY FROM ANY HEATING APPLIANCE.

SAFETY NOTICE

FAILURE TO FOLLOW THESE INSTRUCTIONS CAN RESULT IN PROPERTY DAMAGE, BODILY INJURY OR EVEN DEATH. FOR YOUR SAFETY AND PROTECTION, FOLLOW THE INSTALLATION INSTRUCTIONS OUTLINED IN THIS MANUAL. CONTACT YOUR LOCAL BUILDING OR FIRE OFFICIALS ABOUT RESTRICTIONS AND INSTALLATION INSPECTION REQUIREMENTS (INCLUDING PERMITS) IN YOUR AREA.

THIS WOOD HEATER NEEDS PERIODIC INSPECTION AND REPAIR FOR PROPER OPERATION. CONSULT THE OWNER'S MANUAL FOR FURTHER INFORMATION. IT IS AGAINST FEDERAL REGULATIONS TO OPERATE THIS WOOD HEATER IN A MANNER INCONSISTENT WITH THE OPERATING INSTRUCTIONS IN THE OWNER'S MANUAL.

SAVE THESE INSTRUCTIONS



Manufactured By: Stove Builder International inc., 250, rue de Copenhague, St-Augustin-de-Desmaures (Québec) Canada, G3A 2H3

46311A
2023-01-16

IMPORTANT: IF YOU HAVE A PROBLEM WITH THIS UNIT, DO NOT RETURN IT TO THE DEALER. CONTACT TECHNICAL SUPPORT @ 1-877-356-6663

Tamper Warning:

This wood heater has a manufacturer-set minimum low burn rate that must not be altered. It is against federal regulations to alter this setting or otherwise operate this wood heater in a manner inconsistent with operating instructions in this manual.

Mobile Home Use:

This freestanding pellet unit is approved for mobile home or doublewide installation with the outside combustion air hook-up See the "Installation" section of this manual for details pertaining to mobile home installations. Mobile home installation must be in accordance with the Manufactured Home and Safety Standard (HUD), CFR 3280, Part 24.

WARNING:

USE OF OUTSIDE COMBUSTION AIR IS MANDATORY WITH THIS UNIT. DO NOT OPERATE WITH THE HOPPER OPEN; LID MUST BE SHUT AND TIGHTLY LATCHED DURING OPERATION. DO NOT OVER-FIRE YOUR UNIT.

Note: Englander does not recommend using a pellet stove as your only source of heat.

Retain for your files

Model Number _____

Date of Purchase _____

Date of Manufacture _____

Serial Number _____

IMPORTANT! READ AND FOLLOW **ALL** INSTALLATION AND MAINTENANCE INSTRUCTIONS, INCLUDING CLEANING THE UNIT AS SPECIFIED, AND REPLACING GASKETS ANNUALLY, AND PARTS AS NEEDED.
ENGLANDER IS NOT RESPONSIBLE FOR ANY DAMAGE OR INJURY INCURRED DUE TO NEGLIGENCE, OR DUE TO UNSAFE INSTALLATION OR USAGE OF THIS PRODUCT. CALL TECHNICAL SUPPORT WITH ANY QUESTIONS.

Welcome!

Introduction

- Thank You 4

Specifications

- Heating Specifications 5
- Dimensions 5
- EPA Compliance..... 5

Installation

- Installation Overview..... 6
- Clearances to Combustibles..... 7
- Venting Introduction..... 8
- Venting Guidelines..... 8
- Additional Venting Information.... 9
- Approved Venting Methods
 - Through the Wall 10
 - Through the Ceiling..... 11
 - Existing Chimney..... 12
- Mobile Home Installation..... 13
- Vent Termination Clearances..... 14
- Outside Air Hookup..... 15
- Floor Protection..... 16

Daily Operation

- Control Board Types 17
- Getting Started..... 18
- Lighting a Fire..... 18
- Daily Operation Notes 19

Control Board

- Top Mount Board Settings..... 21
- Error Codes (Top Mount) 23
- Diagnostic Mode (Top Mount) 29
- Side Mount Board Settings..... 31
- Side Mount Error Codes 32
- Power Failure 33

Maintenance

- Daily
 - Important Notes..... 34
 - Daily Ash Removal..... 34

- Cleaning the Burn Pot 35
- Weekly
 - Baffle Removal..... 36
- Monthly
 - Venting Pipe Cleaning 37
- Yearly
 - Important Notes..... 38
 - Burn Pot 39
 - Exhaust Blower 39
 - Convection Blower..... 40
 - Finish 40
 - Gaskets 40
- Basic Troubleshooting 41

Replacing Components

- Convection Blower 43
- Auger Motor 44
- Combustion Blower..... 45
- Vacuum Switch..... 46
- Igniter..... 48
- Gaskets..... 49
- Glass..... 50
- Control Board (Top Mount) 51
- Control Board (Side Mount)..... 53
- Hopper Lid Latch 55

Illustrated Parts Detail

- Exploded Parts Diagram..... 56
- Parts List..... 57

Warranty

- Serial Tag Sample..... 59
- Warranty Details..... 60
- Important Notice..... 62
- Warranty Reg. Form..... 63

INTRODUCTION

Thank you for purchasing this fine product from Englander!

Englander was started, and is still owned, by a family that believes strongly in a “Do It Yourself” spirit; that’s one reason you found this product at your favorite “Do It Yourself” store.

We intentionally design and build our stoves so that any homeowner can maintain their stove with basic tools, and we’re always more than happy to help you do the job as easily and as inexpensively as possible. However, while remaining simple, our stoves are designed to perform extremely efficiently, helping deliver more heat from less fuel.

Please look at the extensive Help section on our website and call our Technical Support Department at (877) 356-6663 if you need any help with your stove. We are nearly always able to “walk you through” any installation issues, repairs, problems or other questions that you may have.

Wishing you years of efficient, quality and “comfy” heating,

Everyone at Englander

Please Note: While information obtained from our web site and through our Technical Support line is always free of charge, there will be a service charge incurred with any “on-site” repairs or maintenance that we may arrange.

This manual is available for free download on the manufacturer’s web site. It is a copyrighted document and resale is strictly prohibited. The manufacturer may update this manual occasionally and cannot be responsible for problems including injuries or damages resulting from the use of information found in any manual from unauthorized sources.

CAUTION: Stove is heavy.

In addition, when handling any sheet metal products, be aware that there may be sharp edges or burrs. Although we make every effort to eliminate any sharp edges, please use caution when handling any metal parts. Remember to disconnect (unplug) the stove from the power source and allow it to completely cool down before performing any maintenance.

SPECIFICATIONS

Heating Specifications

- Approximate Pellet Burn Rate**1.0 to 1.8 kg/hr (2.2 to 3.8 lbs/hr)
- Maximum Burn Time**36 hours
- Approximate Square Footage Heated***up 2,000 sq. ft.
- Hopper Capacity (fuel).....80 pounds

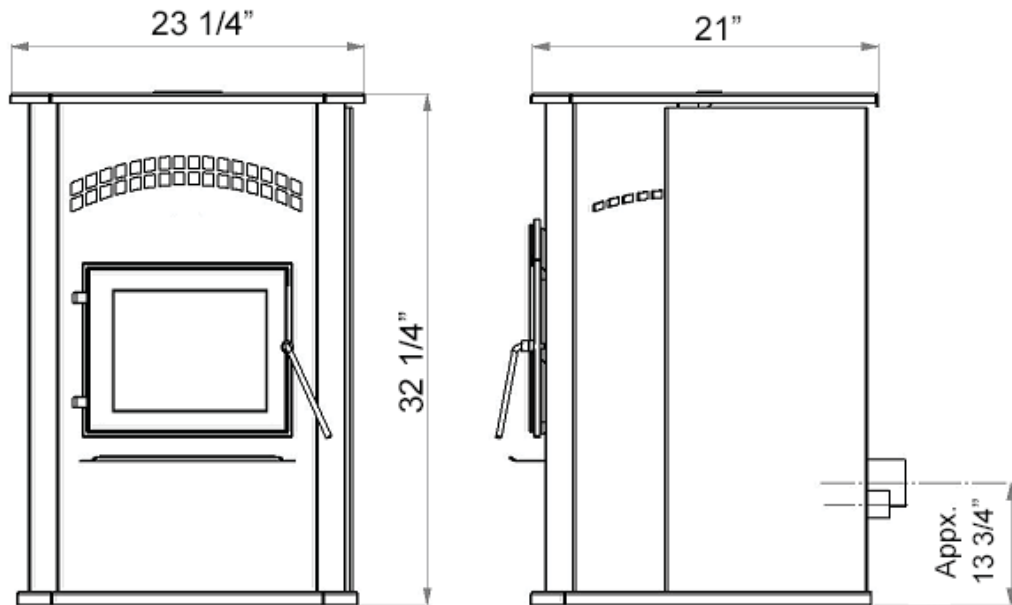

Dimensions

EPA and Safety Compliance Specifications

- EPA Compliance Status Certified to comply with 2020 particulate emission standards using pellet fuel.
- U.S. Test Standard: US EPA 40 CFR Part 60, Subpart 60.536
- Heat output range**** 11,641 BTU/h to 20,959 BTU/h (3.41kW to 6.14 kW)
- Particulate Emissions 1.130 grams/hr
- CO Emissions 0.029 grams/hr
- Efficiency..... 64.1 % (HHV)
- BTU rating 20,511 BTU/hr
- Tested To ASTM E 1509, ASTM E2779, ASTM E2515, CSA B415.1 & ULC S627

Notes for this unit: Product may vary slightly from diagram. Clearances are the minimum for **this unit** and may need to be increased in the rear to have proper vent clearances. **Follow all venting manufacturer clearances and local codes.**

*- As tested per ASTM 2779

** - Heat output, burn rate and maximum burn time are heavily dependent on the type of pellets burned in the stove; as such, these numbers may vary.

*** - The maximum heating capacity of this unit can vary greatly based on climate, construction style, insulation and a myriad of other factors. Use this information in conjunction with a BTU loss calculation for your home to determine if this unit will be sufficient for your needs.

**** - As measured per CSA B415.1-10 stack loss method.

IMPORTANT! READ AND FOLLOW **ALL** INSTALLATION AND MAINTENANCE INSTRUCTIONS, INCLUDING CLEANING THE UNIT AS SPECIFIED, AND REPLACING GASKETS ANNUALLY, AND PARTS AS NEEDED.

ENGLANDER IS NOT RESPONSIBLE FOR ANY DAMAGE OR INJURY INCURRED DUE TO NEGLIGENCE, OR DUE TO UNSAFE INSTALLATION OR USAGE OF THIS PRODUCT. CALL TECHNICAL SUPPORT WITH ANY QUESTIONS.

INSTALLATION

Installation Overview

When choosing a location for your new stove, there are a multitude of factors that should be taken into account before beginning the installation.

1. Traffic Patterns – To help prevent accidents, the stove should be placed in a location where it is out of the way of normal travel through the home.
2. Heat Flow and Efficiency – When deciding on a location for the stove, consider the way heat moves throughout your home. Install the stove where you need the heat; basement installations often do not allow sufficient heat to flow to the upper floors and a top floor installation will not allow any heat to reach the floors below. Always consider that heat rises and will take the path of least resistance while it is still hot.
3. Exhaust Location – Outside walls are generally the best place to install a stove, since they allow easy exhaust and intake air installation (using our Dura Vent AC-3000 Kit, AC-33000 if Canada). If there is not a feasible way to install the stove on an outside wall, there are methods for venting the stove up through the roof, but they tend to be more costly because they involve the use of more pellet vent pipe and can often make outside air installation more difficult.
4. Wall Construction – Locating the stove so that the exhaust system can pass between studs will simplify the installation and eliminate the need to reframe any sections of the wall to accommodate the wall thimble.

Warning

- Do not store or use gasoline or other flammable vapors and liquids in the vicinity of this or any other appliance.
- Do Not Over fire – If any external part starts to glow, you are over firing. Reduce feed rate. Over firing will void your warranty.
- Comply with all minimum clearances to combustibles as specified. Failure to comply may result in a house fire.
- Tested and approved for **wood pellets only**. Burning any other fuel will void your warranty.
- For use with Premium grade wood pellets only.

INSTALLATION

Clearances to Combustibles

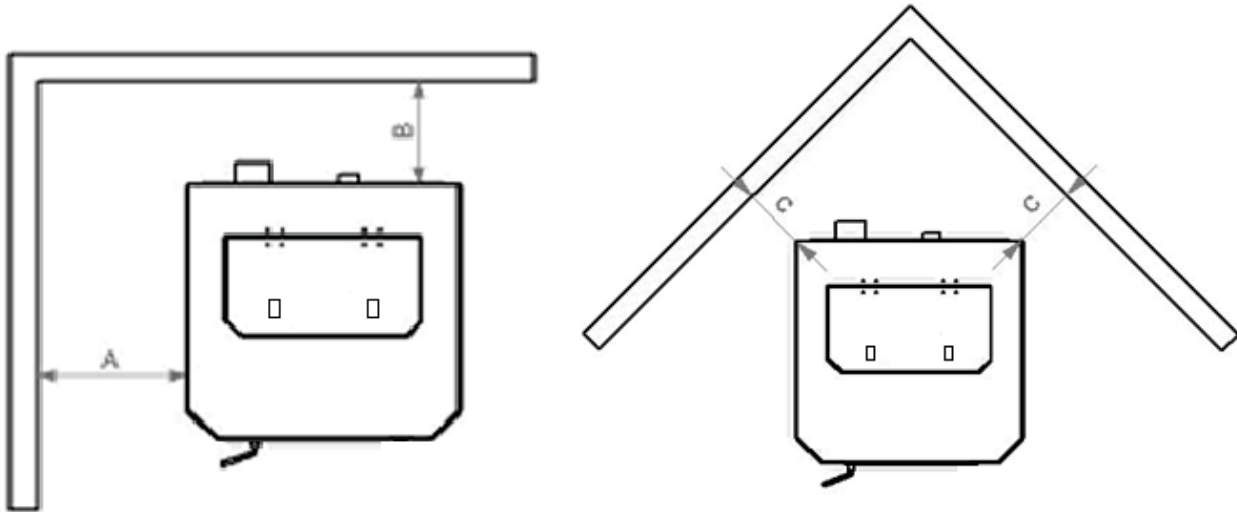

Unit to Side Wall (A)	Unit to Rear Wall (B)	Unit to Corner (C)
7 in.	0 in.	5 in.
178 mm	0 mm	127 mm

CAUTION

- Unit can be very HOT while in operation. Keep children away.
- Supervise children in the same room as this appliance.
- Alert children and adults to the hazards of high temperatures.
- Do NOT operate with protective barriers open or removed.
- Keep clothing, furniture, draperies and other combustibles away.
- Installation MUST comply with local, regional, state and national codes and regulations.
- Consult local building, fire officials or authorities having jurisdiction about restrictions, installation inspection, and permits.

DO NOT CONNECT TO ANY AIR DISTRIBUTION DUCT OR SYSTEM

INSTALLATION

Venting Introduction

This pellet stove operates on a negative draft system, which pulls combustion air through the burn pot and pushes the exhaust air through the vent pipe and out of the building. This unit must be installed in accordance with the following detailed descriptions of venting techniques; not installing the stove in accordance with the details listed here can result in poor stove performance, property damage, bodily injury or death. Englander is not responsible for any damage incurred due to a poor or unsafe installation.

If questions arise pertaining to the safe installation of the stove, our Technical Support line (877-356-6663) is available. Contact your local code official to be certain your installation meets local and national fire codes and if you're uncertain about how to safely install the stove, we strongly recommend contacting a local NFI certified installer to perform the installation.

Venting Guidelines

- **WARNING - INSTALL VENT AT CLEARANCES SPECIFIED BY THE VENT MANUFACTURER.**
- **ALWAYS** install vent pipe in strict adherence with the instructions and clearances included with your venting system.
- **DO NOT** connect this pellet stove to a chimney flue which also serves another appliance.
- **DO NOT** install a flue pipe damper or any other restrictive device in the exhaust venting system of this unit.
- **USE** an approved wall thimble when passing through a wall and a ceiling support/fire stop when passing through a ceiling.
- **ONLY** use 3.0" or 4.0" Type L or Type PL pipe approved for pellet stove venting; **DO NOT** use galvanized or B-Vent pipe.
- **SEAL** each joint of pellet vent with high temperature silicone (Part # AC-RTV3) to prevent smoke spillage into the home.
- **AVOID** excessive horizontal runs and elbows, as both will reduce the draft of the venting system and will result in poor stove performance.
- **INCLUDE** as much vertical pipe as possible to prevent smoke from the unit from entering your home in the event of a power outage.
- **INSPECT** your venting system often, to be certain it is clear of fly-ash and other restrictions.
- **CLEAN** the venting system as detailed in the maintenance section of this manual.

WARNING

- **INSTALL VENT AT CLEARANCES SPECIFIED BY THE VENT MANUFACTURER.**
- **HOT! Do not touch! Severe burns or clothing ignition may result.**
- **Glass and other surfaces are hot during operation.**
- **Do not attempt to touch or open the front, side or back panels during operation. This could result in severe burns or injury.**

INSTALLATION

Additional Venting Information

- Do not mix and match components from different pipe manufacturers when assembling your venting system (i.e. Do **NOT** use venting pipe from one manufacturer and a thimble from another).
- We **require** a minimum vertical rise of 36 in. (3 ft.) of pipe to create natural draft in the system. This helps evacuate smoke from the stove in the event of a power failure or combustion blower failure.
- Venting systems 15.0 ft. or shorter may be composed entirely of 3.0 in. pellet pipe; to reduce frictional losses, venting systems longer than 15.0 ft. should be composed of 4.0 in. pellet pipe.
- Do not terminate the venting system directly beneath any combustible structure such as a porch or deck.
- Follow NFPA 211 rules listed below for venting system termination location relative to windows and other openings in the dwelling.
 - NFPA 211 (2006 ed.) Section 10.4 Termination: 10.4.5
 - (1) The exit terminal of a mechanical draft system other than direct vent appliances (sealed combustion system appliances) shall be located in accordance with the following:
 - (a) Not less than 3 ft. (.91 m) above any forced air inlet located within 10 ft. (3.0m).
 - (b) Not less than 4 ft. (1.2 m) below, 4 ft. (1.2 m) horizontally from or 1 ft. (305 mm) above any door, window or gravity air inlet into any building.
 - (c) Not less than 2 ft. (0.61 m) from an adjacent building and not less than 7 ft. (2.1 m) above grade when located adjacent to public walkways.
- Distance between the termination opening and grade should be a minimum of 2 ft. (24 in.) contingent on the grade surface below the termination. When determining the termination height above grade, consider snow drift lines and combustibles such as grass or leaf accumulation. In areas where significant snowfall is possible, the termination height must be sufficiently high to keep the termination free of snow accumulation.
- Do not use makeshift compromises during installation or install any component of the unit or venting system in such a manner that could result in a hazardous installation.
- A chimney connector shall not pass through an attic or roof space, closet or similar concealed space, or a floor, or ceiling.
- Where passage through a wall or partition of combustible material is desired, the installation shall conform to CAN/CSA-B365.

WARNING:

**Venting system surfaces get HOT, and can cause burns if touched.
Noncombustible shielding or guards may be required.**

INSTALLATION

Approved Venting Method 1: Through the Wall

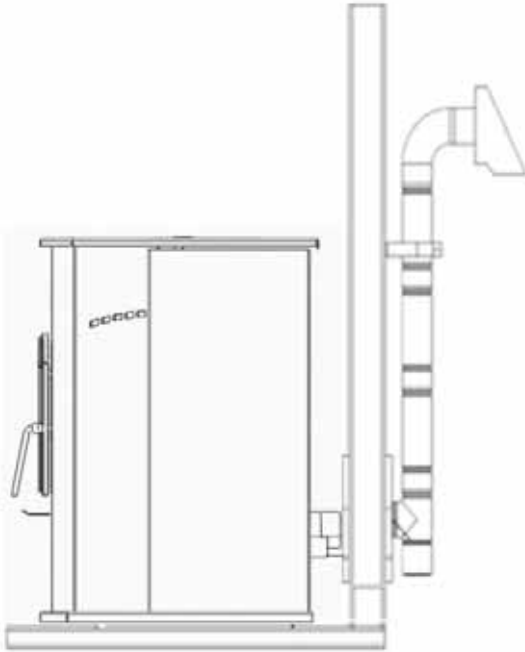

- Generally the simplest installation method, venting through the wall using our AC-3000 kit, AC-33000 if Canada (or similar venting system) is also the preferred venting method. It minimizes horizontal pipe, allows the stove to be installed close to the wall and keeps the clean-out tee on the outside of the house, for ease of cleaning.
- When installing any venting system, **Type L** or **Type PL** pipe must be used and all clearances to combustibles (listed by the pipe manufacturer) must be strictly adhered to.
- Use the pipe manufacturer's approved thimble for passing through a combustible wall, and maintain at least the minimum clearances to combustibles.
- Use an appliance collar where the pellet vent connects to the exhaust output of the pellet stove and attach the appliance collar to the exhaust blower output using three

sheet metal screws.

- Secure the pellet vent to the outside of the house using a wall strap just below the 90 degree elbow.
- Seal each pipe connection joint with high temperature RTV Silicone, to ensure the system is leak free (Check with the specific venting system manufacturer's instructions before doing so).
- If the pellet vent pipe being used is not a "Twist Lock" system, three (3) sheet metal screws are required at each pipe joint.
- Connect the pellet stove to outside combustion air using the kit included with your stove or using an alternative method, as described in the "Outside Air" section, on page 15.

This installation type can be modified for basement (**Basement installations should always be performed by a professional installer**) or other installations wherein the tee and vertical section of the pipe would be inside the home and the venting system would simply pass horizontally through the thimble and then terminate.

For high altitude installations (above 4,000 ft.), the vent pipe should be increased from 3-inch (3") to four-inch (4").

Please Note:

Installation diagrams are for reference purposes only and are not drawn to scale, nor meant to be used as plans for each individual installation. Please follow all venting system requirements, maintain the required clearances to combustibles, and follow all local codes.

INSTALLATION

Approved Venting Method 2: Through the Ceiling

For high altitude installations (above 4,000 ft.), the vent pipe should be increased from 3-inch (3") to four-inch (4").

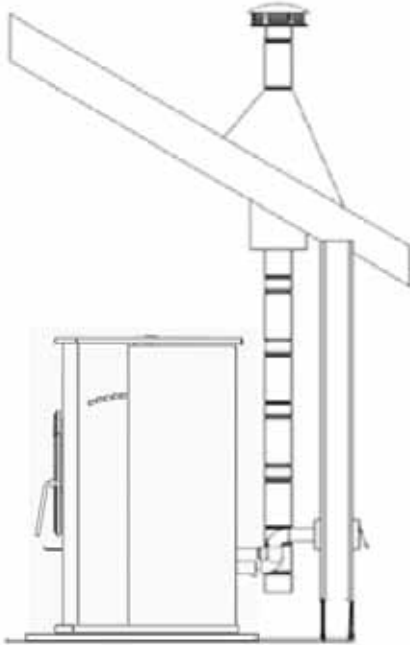

- Venting through the ceiling/roof may be the only feasible venting option in some cases and is a factory recommended installation.
 - When installing any venting system, **Type L** or **Type PL** pipe must be used and all clearances to combustibles listed by the pipe manufacturer must be strictly adhered to.
 - Use the pipe manufacturer's approved ceiling support for passing through a combustible ceiling, as well as the required fire stops, radiation shields, flashing and storm collar.
 - Be certain to follow the manufacturer's required height of termination above the roof line, and maintain at least the minimum clearances to combustibles.
 - Use an appliance collar where the pellet vent connects to the exhaust output of the pellet stove and attach the appliance collar to the exhaust blower output using three sheet metal screws.
- Seal each pipe connection joint with high temperature RTV Silicone, to ensure the system is leak free (Check with the specific pipe manufacturer's instructions before doing so).
 - If the pellet vent pipe being used is not a "Twist Lock" system, three (3) sheet metal screws are required at each pipe joint.
 - Connect the pellet stove to outside combustion air using the kit included with your stove or using an alternative method, as described in the "Outside Air" section, on page 15.
 - This venting method can also be modified so that the venting system runs horizontally through the wall from the stove, then transitions to vertical and terminates above the roofline. When using this modified version of this installation be certain to carefully follow the venting system manufacturer's instructions diligently.

Please Note:

Installation diagrams are for reference purposes only and are not drawn to scale, nor meant to be used as plans for each individual installation. Please follow all venting system requirements, maintain the required clearances to combustibles, and follow all local codes.

INSTALLATION

For high altitude installations (above 4,000 ft.), the vent pipe should be increased from 3-inch (3") to four-inch (4").

Approved Venting Method 3: Existing Chimney System

- Using an existing masonry or factory built chimney for venting is the only other acceptable method for venting this pellet unit.

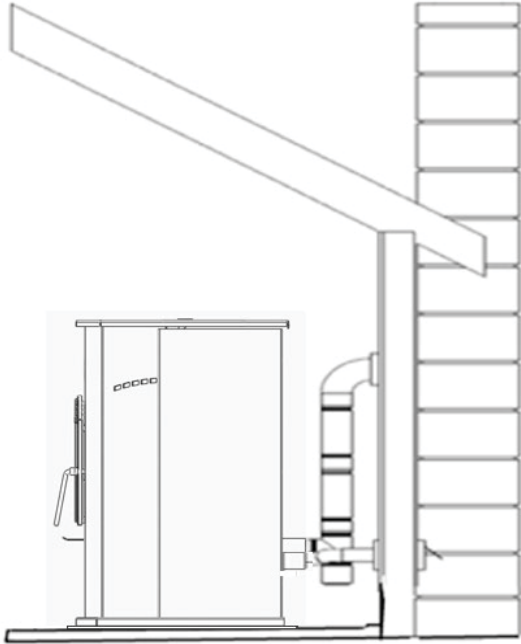

- Use **Type L** or **Type PL** venting pipe until entering the existing chimney. Use the appropriately sized adapter when transitioning from the pellet vent pipe to the masonry or factory built thimble and be certain that the adapter is sealed tightly to both the pellet venting system and the existing chimney.
- Before using an existing chimney, be certain it is in good condition (A chimney sweep inspection is highly recommended). Also, make sure the chimney meets the minimum standards listed in NFPA 211 (A chimney professional can confirm this upon inspection).
- If connecting this stove to a factory built chimney, it may **ONLY** be a 6" flue, UL103 HT venting system (ULC S629 if Canada). Connection to any other factory built chimney may result in a poorly operating or dangerous stove installation.

- When connecting to an existing masonry chimney, the cross-sectional area of the flue must be considered. A chimney with a flue larger than 6" round (28.27 sq. in.) may require relining with an approved pellet stove chimney lining system.
- Use an appliance collar where the pellet vent connects to the exhaust output of the pellet stove and attach the appliance collar to the exhaust blower output using three sheet metal screws.
- Seal each pipe connection joint with high temperature RTV Silicone, to ensure the system is leak free (Check with the specific pipe manufacturer's instructions before doing so).
- If the pellet vent pipe being used is not a "Twist Lock" system, three (3) sheet metal screws are required at each pipe joint.
- Connect the pellet stove to outside combustion air using the kit included with your stove or using an alternative method, as described in the "Outside Air" section, on page 15.

Please Note:

Installation diagrams are for reference purposes only and are not drawn to scale, nor meant to be used as plans for each individual installation. Please follow all venting system requirements, maintain the required clearances to combustibles, and follow all local codes.

INSTALLATION

For high altitude installations (above 4,000 ft.), the vent pipe should be increased from 3-inch (3") to four-inch (4").

Mobile Home Installation

- The Englander outside air kit **MUST** be used for installation of this unit in a mobile home. Please see the "Outside Air" section on page 15 for more information regarding outside air connections.
- The outside air inlet must be kept clear of leaves, ice and other debris. Keeping the outside air inlet free of restriction is crucial to preventing air starvation and smoke spillage.
- The pellet stove **MUST** be secured to the floor of the mobile home using lag bolts and the holes provided in the bottom of the base for this purpose. Outdoor-aired space heaters must be attached to the structure.
- The pellet stove **MUST** be grounded with #8 solid copper grounding wire (or equivalent), terminated at each end with an NEC approved grounded device.
- Carefully follow all clearances listed in the appropriate section of this manual AND follow the venting manufacturer's minimum clearance requirements. Similarly, be certain the venting system used is approved for mobile home use.
- Installation must be in accordance with Manufacturers Home & Safety Standard (HUD) CFR 3280, Part 24 as well as any applicable local codes.
- Use silicone to create an effective vapor barrier at the location where the chimney or outside air ducting passes through to the exterior of the structure.

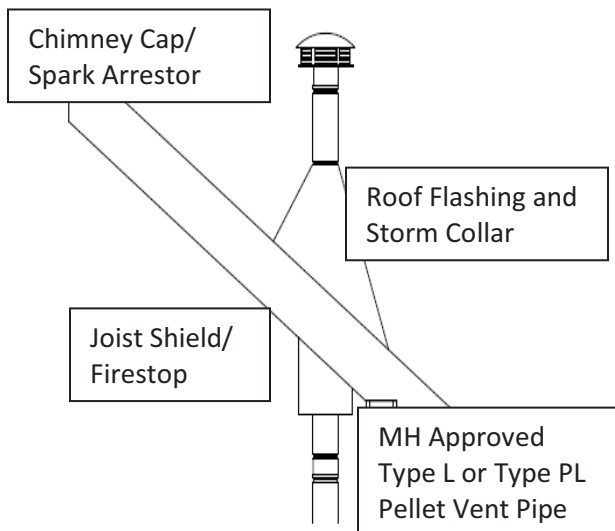

If your unit does not have holes pre-drilled for Mobile Home installation, you may drill two holes in the floor of your unit that are 1/2" (approx.. 1.25 cm) in diameter. Each hole should be drilled approximately 3" (7.6 cm) inside the rear of the unit, and approximately 4.625" (11.75 cm) away from the center of the floor.

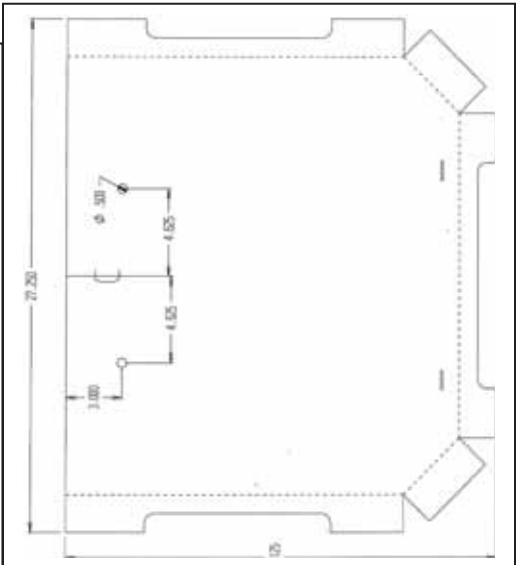

CAUTION

THE STRUCTURAL INTEGRITY OF THE MANUFACTURED HOME FLOOR, WALL AND CEILING/ROOF MUST BE MAINTAINED. DO NOT CUT THROUGH FLOOR JOISTS, WALL STUDS, CEILING TRUSSES OR ANY OTHER SUPPORTING MATERIAL WHICH COULD BE DETRIMENTAL TO THE STRUCTURAL INTEGRITY OF THE HOME.

WARNING: DO NOT INSTALL IN A SLEEPING ROOM.

VENT TERMINATION CLEARANCES

- A) Min. 4-ft clearance below or beside any door or window that opens.
- B) Min. 1-ft clearance above any door or window that opens.
- C) Min. 2-ft clearance from any adjacent building.
- D) Min. 7-ft clearance from any grade when adjacent to public walkways.
- E) Min. 2-ft clearance above any grass, plants, or other combustible materials.
- F) Min. 3-ft clearance from a forced air intake of any appliance.
- G) Min. 2-ft clearance below eaves or overhang.
- H) Min. 1-ft clearance horizontally from combustible wall.
- I) Vents installed with mechanical exhausters shall terminate not less than 12 in. (305mm) above the highest point where they pass through the roof surface.

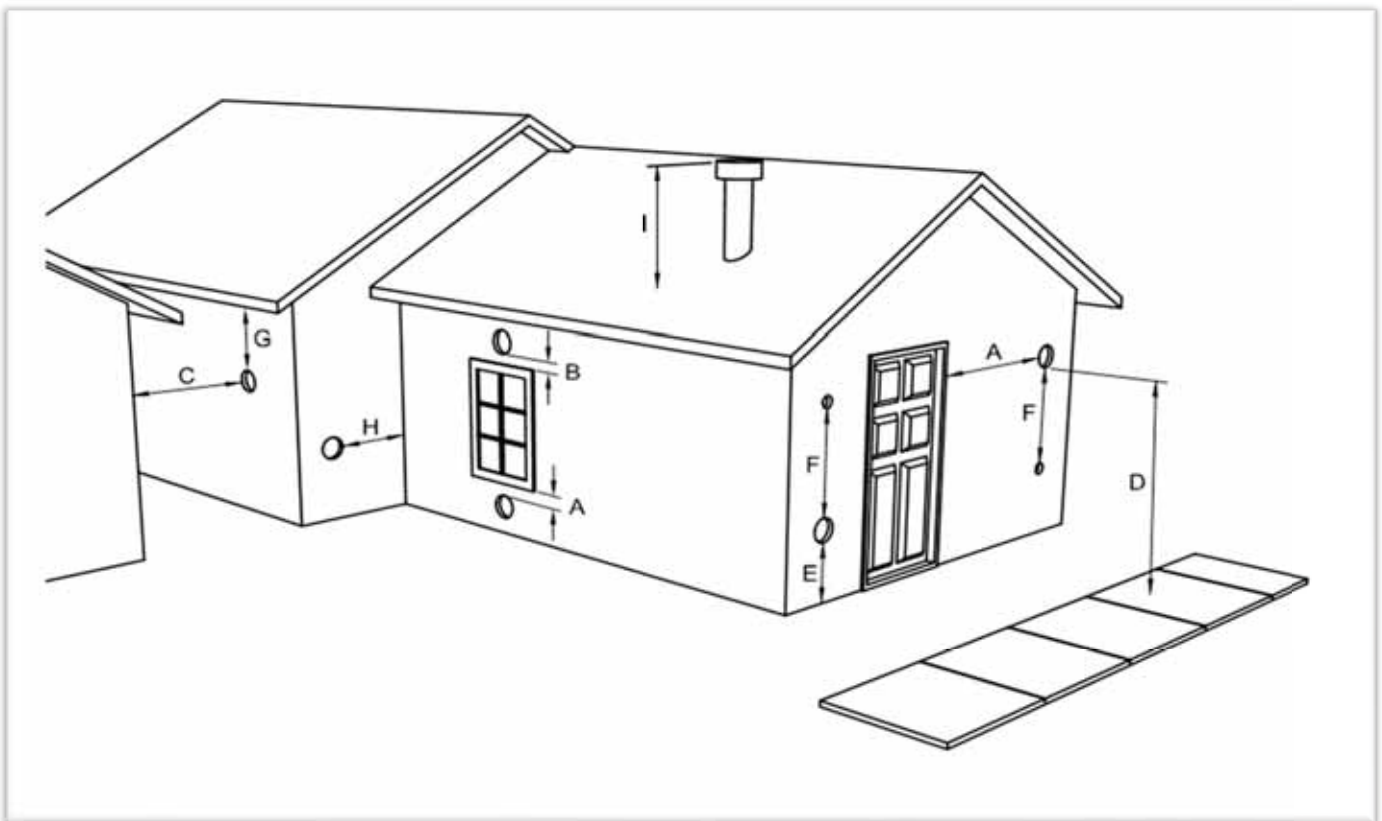

Notes on termination of Pellet Vent Pipe from NFPA 211 (2006 ed.) Section 10.4 Termination: 10.4.5
(See also "INSTALLATION" section of manual AND additional notes above):

- Not less than three (3) feet above any forced air inlet located within ten (10) feet.
- Not less than four (4) feet below, four (4) feet horizontally from, or one (1) foot above any door, window or gravity air inlet into any building.
- Not less than two (2) feet from an adjacent building, and not less than seven (7) feet above grade where located adjacent to public walkways.

The exhaust exit shall be arranged so that the flue gases are not directed so that it will affect people, overheat combustible structures, or enter buildings. Forced draft systems and all parts of induced draft systems under positive pressure during operation shall be installed gastight or to prevent leakage of combustion products into a building. Through-the-wall vents shall not terminate over public walkways, or where condensate or vapor could create hazards or a nuisance.

*Be sure to follow local codes and all manufacturer's instructions (including exhaust pipe).
Consult a professional installer and/or call Technical Support if you have any questions.*

OUTSIDE AIR HOOK-UP

- The use of outside combustion air is **mandatory** on this pellet stove.
- The outside air connection pipe protrudes from the lower rear center of the stove; use the included outside air kit to attach your stove to outside combustion air. Instructions and all the parts needed to make the outside air connection to your pellet stove are included with the outside air kit.
- If it is not feasible to use the included outside air hookup kit in your stove installation, other materials may be used, provided the following rules are followed:
 - The pipe used for outside air hookup must be metal, with a minimum thickness of .0209 in. (25 gauge mild steel) or greater and an inside diameter of approximately 2.0 in.
 - All pipe joints and connections should be sealed with pipe clamps or other mechanical means, to insure a leak free outside air connection.
 - Long runs of pipe and excessive elbows for outside air should be avoided. Due to frictional resistance in pipe, any excessive outside air piping can result in poor stove performance.
 - A screen or other protection device must be fitted over the outside air termination point to prevent rain, debris and nuisance animals from entering the piping system.
 - Increase the outside air pipe size to 3.0 in. diameter pipe if the outside air connection is more than 6 ft. in length, more than two (2) elbows are used or if the stove is installed in a basement.
- The outside air connection system should be inspected at least annually to be certain it is free from blockage.

Caution

NEVER draw outside combustion air from:

1. Wall, floor or ceiling cavity.
2. Enclosed space such as an attic, garage or crawl space.

FLOOR PROTECTION

- This pellet stove requires a non-combustible floor protector if the stove is to be installed on a combustible floor. If the floor the stove is to be installed on is already non-combustible (i.e. a concrete floor in a basement) and has an R value equal to or higher than .2, no floor protection is needed (although a decorative floor protector can still be used for aesthetic reasons).
- Prefabricated floor protectors which are UL listed (ULC if Canada) or equivalent can be purchased or a floor protector can be built from standard materials: two sheets of .5" thick cement board covered with ceramic tile would be a suitable floor protector which meets the .2 R-value requirement.
- When using any floor protector, consider that this stove is not only heavy but will induce heating and cooling cycles on the floor protector which can damage tile and loosen mortar and grout joints. A hearth rug is **NOT** an approved substitute for a proper hearth pad.
- **For the US:** The floor protector must extend at least 6 in. (152.4 mm) from the front & sides and 4 in. (101.6 mm) from the rear.
- **For Canada:** The floor protector must extend at least 18.0 in. (457.2 mm) from the front of the unit, 8.0 in. (203.2 mm) from the sides of the unit and 4.0 in. (101.6 mm) from the rear.
- **In Canada,** it is required that the non-combustible floor protector is underneath and extends 2 in. (50.8 mm.) on either side of any horizontal venting runs **AND/OR** is directly underneath any vertical venting pipe.

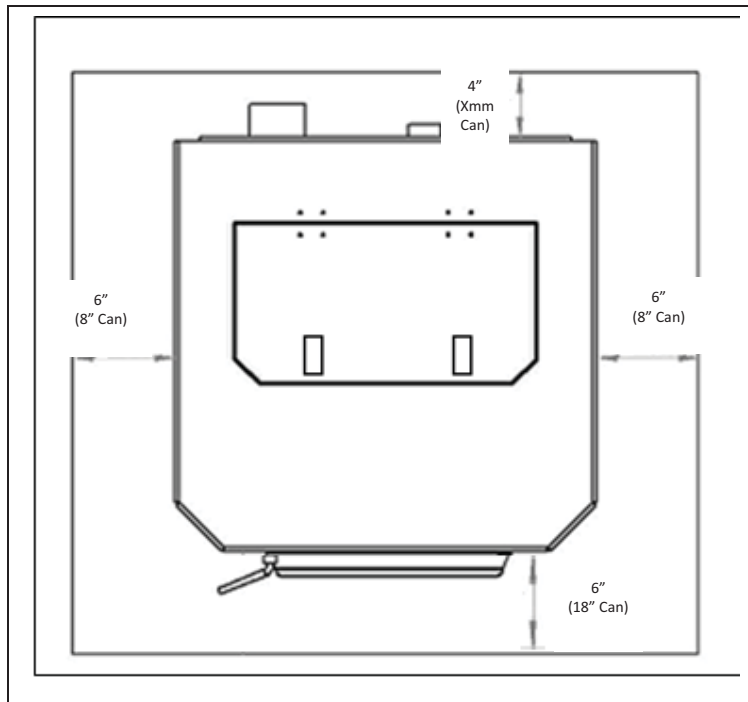

CONTROL BOARD TYPES

Control Board Types

Your stove may come equipped with a control board that is mounted on the top of the stove, behind the hopper (“Top Mount”), or it may come equipped with a control board that is mounted on the side wall of the unit (“Side Mount”).

For reference, a Top Mount control board looks like this:



And a side mount control board has separate windows for Heat Range and Blower Speed, like this:

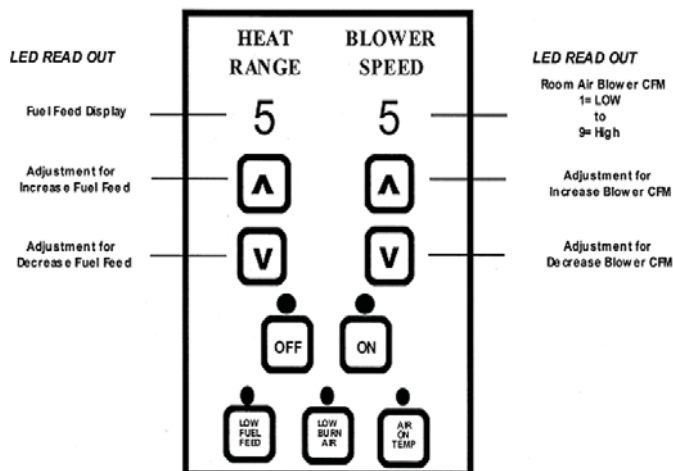

PLEASE NOTE that some instructions in this manual apply to the TOP MOUNT board, and other instructions apply to the SIDE MOUNT board.

Differences will be called out so that you may know what instructions apply to your particular stove.

DAILY OPERATION

Getting Started

- Check to see that the hopper is clean and free from foreign materials. Be sure to connect this unit to a working outlet; we recommend using a surge protector to help protect the electronic components from damage.
- **BEFORE** your first fire, dry run your unit (**no** pellet fuel in the hopper) for twenty minutes; pressing the “ON” button with the unit plugged in will initiate the dry run.
 - When the “ON” button is pressed:
 - Top Mount control boards: the board will scroll the message “DID YOU CLEAN BURN POT BEFORE STARTING? HOLD ON TO CONFIRM”. Press and hold the “ON” button for **3 seconds** to start the unit.
 - Side Mount boards: After a few seconds, the letters “S U” will appear in the display windows.
 - Once the unit starts, you should immediately hear the exhaust blower start and operate continuously. The board will display the last setting it was set to for the duration of its operation, or until the setting is adjusted. (Side Mount control boards will continue to show “S U”).
 - After about three to five minutes, look for the red glow of the igniter in the igniter port of the burn pot to be certain it is operating normally.
 - Hold the hopper lid switch (See “Illustrated Parts Diagram” at rear of this manual) down with your finger and check to see that the auger is turning. Release the hopper lid switch and be certain that the auger stops turning. **DO NOT PUT YOUR FINGERS IN THE HOPPER OR NEAR THE ROTATING AUGER.**
 - Top Mount boards Please Note: If the lid switch is left disengaged (not pressed down) for 60 seconds, the unit will shut down with an error message of “HOPPER LEFT OPEN. SHUTTING DOWN – if this happens, the unit must be allowed to shut down and the dry run would then need to be repeated from the beginning.
 - Note that the front door must be closed for the auger to cycle (the board will not give a vacuum loss error, as the board does not look for this until proof of fire is met, but the auger will not cycle if the door is open).
 - Top Mount boards: After approximately twenty minutes, the control board should display “FAILED TO START SHUTTING DOWN” several times, and then it will continue to display “FAILED TO START”. To clear the error message simply press the “OFF” button.
 - Side Mount boards will display “E-2” in the two display windows (more information on Error Codes can be found in the Error Code section of this manual).
 - At this point, the dry run is complete and your pellet heating appliance is ready for normal operation.

Lighting a Fire

- In order for this stove to operate, the hopper must first be filled with pellet fuel. Lift the hopper lid and pour the pellet fuel directly into the hopper. Of course, your stove should be connected to your venting system at this point.
 - ❖ We recommend using only pellets manufactured by PFI Certified facilities, since pellets bearing the PFI stamp of approval will be low in ash and moisture, high in BTU’s, and uniform in size and quality.
- This pellet stove will perform equally well using softwood and hardwood pellets, and although the ash may differ slightly in appearance or texture, both types of pellets will burn cleanly and efficiently in this stove.
 - This pellet stove is equipped with an automatic pellet ignition system. Simply press the “ON” button

- Top Mount boards: when the “ON” button is pressed, the board will scroll the message “DID YOU CLEAN BURN POT BEFORE STARTING? HOLD ON TO CONFIRM”. Press and hold the “ON” button for **3 seconds** to start the unit.
- Side Mount boards: Shortly after pressing the “ON” button, the letters “S U” will appear in the display windows of the board. This indicates the stove has entered the start-up sequence and is operating normally.
- After initiating the start-up as described above, the most recent setting will appear in the window of the control board (Side Mount boards will continue to show “S U”). This indicates the stove has entered the start-up sequence and is operating normally.
- The fuel feed rate and combustion air during start-up is determined by the control board, so the stove may be started on any heat range.
- After approximately fifteen minutes, the fire should be burning brightly. At this point, the stove has begun normal operation and the display windows on the control board will display your setting, unless the board is adjusted.
- It is normal for the unit to smoke during the first fire, as paints and oils cure. This should dissipate within the first hour. Open a door and/or window during the first fire to ventilate the area.

Daily Operation Notes

- Only high quality, Premium Grade ¼” (.25 in.) diameter wood pellets should be used in this stove. Using low grade wood pellets with high ash content OR wood pellets with a high moisture content can cause the burn pot to fill with ash at a more rapid pace and can cause intervals between periodic maintenance to become significantly shorter. Please read the “Maintenance” section of this manual thoroughly to understand how fuel selection affects stove operation, maintenance and cleaning.
- Variation in the flame height is normal; not all wood pellet fuel is uniform in size, which can affect the way pellets are fed into the burn pot. Although the flame height may increase and decrease during operation, there is no loss of efficiency.
- Always store wood pellet fuel in a dry location; storing wood pellet fuel in a dry location ensures the fuel will remain pelletized and low in moisture content. Also, be certain that all wood pellet fuel is stored at a safe distance from the pellet heater; storing fuel in close proximity to the stove can result in a fire. **Do not install or operate this unit outside, in a greenhouse, or in any area that is high in moisture.**
- This pellet burning room heater is equipped with a specially designed burn pot which comes preinstalled from the factory. This burn pot elevates the burning pellets and delivers air at the precisely-required locations. Pellets must only be burned in the factory burn pot; no modifications should be made to this burn pot and no additional grates or other fire elevators should be used.

- Top Mount board: The circuit board is equipped with “Reminder Messages” which will pop up and scroll on the display at various times.
- **The following apply to the Top Mount board only:**
- As noted above, the control board will ask the user if they have cleaned out the burn pot prior to every start with “HOLD ON TO CONFIRM”.
- “Daily cleaning reminder” - After the unit has run for 46 consecutive hours of burn time, the board will display a reminder to shut the unit down and perform daily cleaning with “PLEASE SHUT DOWN AND CLEAN BURN POT”. This reminder code does NOT shut the unit down, but WILL scroll until the unit is completely shut down by the user. Control of the stove is not affected by the scrolling message; the user can adjust the control board and it will display the adjustment and then revert back to the scrolling message until the user shuts the unit down.
- “Weekly maintenance reminder” - After 7 days of cumulative run time, the control board will display a scrolling reminder message to confirm the user has performed the weekly maintenance required with “DID YOU PERFORM WEEKLY MAINTENANCE? HOLD ON BUTTON TO CONFIRM”. Again, the message does not affect the unit’s operation, and in this case can be cleared by holding the “ON” button for 3 seconds, at which time the board status will return to its previous state.

CAUTION

NEVER USE GASOLINE, GASOLINE-TYPE LANTERN FUEL, KEROSENE, CHARCOAL LIGHTER FLUID, OR SIMILAR LIQUIDS TO START OR “FRESHEN UP” A FIRE IN THIS HEATER. KEEP ALL SUCH LIQUIDS WELL AWAY FROM THE HEATER WHILE IN USE. ADDITIONALLY, NEVER APPLY FIRE-STARTER TO ANY HOT SURFACE OR EMBERS IN THE STOVE. DO NOT USE CHEMICALS OR FLUIDS TO START THE FIRE.

DO NOT BURN FLAMMABLE FLUIDS SUCH AS GASOLINE, NAPHTHA OR ENGINE OIL. DO NOT BURN GARBAGE; LAWN CLIPPINGS OR YARD WASTE; MATERIALS CONTAINING RUBBER, INCLUDING TIRES; MATERIALS CONTAINING PLASTIC; WASTE PETROLEUM PRODUCTS, PAINT OR PAINT THINNERS, OR ASPHALT PRODUCTS; MATERIALS CONTAINING ASBESTOS; CONSTRUCTION OR DEMOLITION DEBRIS; RAILROAD TIES OR PRESSURE-TREATED WOOD; MANURE OR ANIMAL REMAINS; PAPER PRODUCTS, CARDBOARD, PLYWOOD OR PARTICLEBOARD. THE PROHIBITION AGAINST BURNING THESE MATERIALS DOES NOT PROHIBIT THE USE OF FIRESTARTERS MADE FROM PAPER, CARDBOARD, SAWDUST, WAX AND SIMILAR SUBSTANCES FOR THE PURPOSE OF STARTING A FIRE IN AN AFFECTED WOOD HEATER. BURNING THESE MATERIALS MAY RESULT IN RELEASE OF TOXIC FUMES OR RENDER THE HEATER INEFFECTIVE AND CAUSE SMOKE.

CONTROL BOARD SETTINGS – TOP MOUNT BOARD

Please Note: The following section gives instructions for stove models with the Top Mount control board (where the control board is mounted on the top of the stove, behind the hopper).

Please see the section of the manual “Control Board Settings – Side Mount Board” for instructions pertaining to stoves with a Side Mount control board.

Manual/Automatic Mode

Automatic Mode

Your stove will arrive from the factory programmed in automatic mode. First, make sure the thermocouple wire is resting loosely outside the back of the stove (so that it is reading the air temperature) in a safe location where it can't be damaged. It should not rest directly on the floor, or it will pick up the floor temperature. The thermocouple wire is the “room temperature heat sensor” whereby the control board will read the room temperature.

In this mode, after initiating the startup sequence, you select the desired room temperature (ranging from 60 to 90 degrees F) by pressing the Up or Down arrows, and the stove will operate the auger feed and blower speed according to the temperature you have selected.

The stove will heat to whichever temperature you set the stove at until the call for heat leaves, at which point the stove will adjust itself higher or lower as needed, depending on the room temperature readings supplied by the room heat sensor.

To turn the stove off completely, press the OFF button on the control board.

Manual Mode

Your stove can be changed to run in manual mode, if desired. In manual mode, after pressing the ON button, the stove will run continuously, based on desired heat range and blower speed settings. The heat range settings will be 1 through 9 (the Up arrow will increase the heat range and the Down arrow will decrease the heat range), with 1 being the lowest auger feed setting and 9 being the highest. The blower speed range will match the heat range that you have set.

Since the stove runs continuously at the selected heat range in this mode, it is generally recommended for stoves installed in less-insulated areas of the home and extremely cold climate regions.

To turn the stove off completely, press the OFF button on the control board.

Setting Stove in Manual Mode

- To set the stove in Manual Mode: With the stove plugged in press the down arrow and the up arrow button simultaneously. This will toggle your stove to Manual Mode.
- While in Manual Mode, the stove board will display M1 (the lowest setting) and can be adjusted with the up and down arrows.

Setting Stove in Automatic Mode

- To set the stove back into automatic mode, press the down arrow and the up arrow button simultaneously. This will toggle the stove to Automatic Mode.
- While in Automatic Mode, the stove board will display the Set Temperature.
- The control board on this stove allows the user to adjust the heat output and convection blower speed, turn the unit on and off, and test components for function (more on diagnostic mode later).

CAUTION

This unit is meant to operate only with door closed. Smoke spillage and an inefficient, lazy burn will result from attempting to operate the stove with the door open.

In addition, using fuel other than wood pellets can create an unsafe situation and can also generate excess carbon monoxide. Carbon monoxide is an odorless, colorless gas which can be deadly. Be sure to burn only wood pellets.

The use of a carbon monoxide detector is strongly recommended.

ERROR CODES – Top Mount Control Board

Error messages will appear and scroll across the display of the control board if the unit experiences an abnormal condition. When these errors occur, the unit will proceed to a shutdown cycle, during which time the control board will not permit the unit to be restarted. At the end of the shutdown cycle, the control board will allow the code to be cleared and/or the unit to be restarted. In the event an error message appears, however, it is recommended to refer to the troubleshooting section of the manual (or call Tech. Support if needed), to determine and correct the underlying cause of the message's appearance.

NOTE: See next section for information on Troubleshooting the Error Codes

Failed to start

- If the unit does not reach its minimum operating (or "Proof of Fire") temperature by the end of the allotted startup time, the control board display will scroll "FAILED TO START SHUTTING DOWN", at which time the unit will initiate a shutdown cycle. The message will continue to scroll during this time until the unit shuts completely off. During this time, the stove cannot be restarted; if the "ON" button is pressed during this shutdown, the unit will scroll "STOVE MUST SHUT DOWN TO CLEAR ERROR" once, before reverting to the previous message.
- Once the unit has shut down completely, the display will continue to scroll "FAILED TO START". At this point the stove can be restarted in its normal sequence by pressing the "ON" button, or the code can be cleared by pressing the "OFF" button.

Failed on Over Temp

- If, at any time while the unit is in operation and the firebox sensor reads too high of a temperature, the unit will display the following message: "FAILED ON OVER TEMP SHUTTING DOWN". The unit will then initiate a shutdown cycle, and the message will continue to scroll during this time until the unit shuts completely off. During this shutdown, the stove cannot be restarted; if the "ON" button is pressed during shutdown the unit will scroll "STOVE MUST SHUT DOWN TO CLEAR ERROR" once, before reverting to the previous message.
- Once the unit has shut down completely, the display will scroll "FAILED ON OVER TEMP". At this point the stove can be restarted in its normal sequence by pressing the "ON" button, or the code can be cleared by pressing the "OFF" button.

Vacuum Loss

- This unit is equipped with a vacuum actuated "Door Ajar" safety switch. If this switch is sensed as being open for a period of 30 continuous seconds, the control board will scroll

“FAILED ON VACUUM LOSS SHUTTING DOWN”. The unit will then initiate a shutdown cycle, and the message will continue to scroll during this time until the unit shuts completely off. During this shutdown, the stove cannot be restarted; if the “ON” button is pressed during shutdown the unit will scroll “STOVE MUST SHUT DOWN TO CLEAR ERROR” once, before reverting to the previous message.

- Once the unit has shut down completely the control board will scroll “FAILED ON VACUUM LOSS”. At this point the stove can be restarted in its normal sequence by pressing the “ON” button, or the code can be cleared by pressing the “OFF” button.

Hopper Left Open

- This unit is also equipped with a hopper lid safety switch that is actuated by a tab which is part of the hopper lid. The switch is a required safety device, which prevents the auger from cycling when the lid is open. An error message is triggered if the lid is left open for 60 continuous seconds - if this occurs, the control board will scroll “HOPPER LEFT OPEN SHUTTING DOWN”. The unit will then initiate a shutdown cycle, and the message will continue to scroll during this time until the unit shuts completely off. During this shutdown, the stove cannot be restarted; if the “ON” button is pressed during shutdown the unit will scroll “STOVE MUST SHUT DOWN TO CLEAR ERROR” once, before reverting to the previous message.
- Once the unit has shut down completely the control board will scroll “HOPPER LEFT OPEN”. At this point the stove can be restarted in its normal sequence by pressing the “ON” button, or the code can be cleared by pressing the “OFF” button.

If an error code continues to display, if the error code seems unexplainable, or if you have any other questions about error codes and what they mean, please contact Technical Support at (877) 356-6663.

ERROR MESSAGE TROUBLESHOOTING – Top Mount Board

NOTE: In some cases it will be recommended that you run “Diagnostic Mode” while Troubleshooting. See the section immediately following this section for information on running the Diagnostic Mode for your stove.

Failed to start

Each time the unit is powered up it should be clean; the burn pot should be empty; fuel should be already loaded into the hopper and both the loading door (hopper lid) and the front door **must** be closed. When powered up, the unit will start the draft (exhaust) blower and begin delivering fuel through the feed system. The igniter will begin to heat up, as well. Once the fuel has reached the level of the igniter hole in the burn pot, the heat from the igniter should quickly begin igniting the fuel. Once lit and burning, the unit will continue in this state until the firebox heat sensor recognizes “proof of fire,” at which point the unit should exit the startup sequence and begin heating at the setting that was chosen by the user. If the unit does not reach the operating “proof of fire” temperature, a Failed to start error will appear.

Potential causes:

- Draft (exhaust) blower not running - if the draft blower is stuck, defective or plugged up and is unable to run, the unit will not feed. The airflow generated by the draft blower activates a vacuum switch that tells the control board the front door is closed and the draft blower is pulling sufficient air through the burn pot to support the fire.
 - Solution: Clean the stove and flue system. Clean out the draft blower and check to ensure the impellor rotates freely. Check wire connections at the blower; test in diagnostic mode. If the draft blower still does not run, replace the draft (exhaust) blower.
- Draft (exhaust) blower running but no fuel being fed (auger not turning) - This would indicate one of the following issues: Clogged auger or defective auger motor; Vacuum switch circuit open; Improper venting method; Hopper lid switch circuit open.
 - Clogged auger or defective auger motor - clear hopper and feed system. Check for “play” in auger. Test in diagnostic mode.
 - Defective auger motor - if auger is clear but will not run in diagnostic mode, replace the auger motor.
 - Vacuum switch open circuit - ensure the door closes tightly. Next, inspect the vacuum port (in the right rear wall of burn chamber to the right of the burn pot cradle) for blockage. To clean this vacuum port, insert a toothpick or similar implement into the mouth of the port and (gently) swirl it around while sliding it back out to ream out the opening. This port should not be vacuumed out aggressively (i.e. with any type of vacuum), as it could damage the switch. Next, clean the heat exchange areas and flue system. Test in diagnostic mode; if the circuit still shows ‘open,’ check the wire connections both at the switch and the control board. Test again in diagnostic mode; if still open replace vacuum switch.

- Improper venting method - as stated above, one of the key requirements for proper operation is proper airflow through the entire system. Venting systems with excessive elbows and/or long horizontal runs can restrict the flow of air to the point that the vacuum switch may not receive enough pressure to hold it closed. This would prevent feed, as the control board would assume the front door is open. A dirty flue system can restrict airflow in the same manner, even if installed correctly. Refer to the installation guide to determine if the installation is within specifications.
 - Hopper lid switch circuit open - ensure the hopper lid is closing enough to engage the switch. Test in diagnostic mode. Ensure the switch can be pushed manually with hopper open. Check wires at switch and control board; test again in diagnostic mode. If the circuit still shows 'open,' replace the hopper lid switch.
- Feeds but doesn't light - Test igniter in diagnostic mode; remove the burn pot for observation. After energizing the ignitor circuit, allow approximately 4 minutes for the cartridge to fully heat up and observe the igniter sleeve. Check wires at igniter. Replace igniter.
 - Stove lights but still has error - Test firebox sensor in diagnostic mode. Check connection at control board. Verify mounting screw for sensor on exhaust coupler is tight. Replace firebox heat sensor.

Over Temp

An over temp error message will appear when the firebox heat sensor reads too high of a temperature. The unit can produce a large amount of heat, which is convected out into the room by a convection (room air) blower that runs at a rate determined by the control board. If the stove is unable to shed the generated heat, the unit itself will retain a higher percentage of this heat and eventually will shut down.

Potential causes:

- Room air blower not running or dirty - test in diagnostic mode. If the blower does not run, remove rear panel and verify that the blower fan rotates freely. Clean out the fan. Check wire connections. Replace room air blower.
- Excessive ash buildup or improper venting - remove baffle and clean the heat exchange behind the baffle.
- Improper venting method / Clean flue system - as stated above, one of the key requirements for proper operation is proper airflow through the system. Venting systems with excessive elbows and/or long horizontal runs can restrict the flow of air, causing a buildup of fuel in the burn pot and higher exhaust temperatures. Also, a dirty vent system does not allow as much heat transfer, causing excessive heat to be wasted through the exhaust, where the firebox heat sensor is located.
- Confined space - If the unit is installed in a small room or alcove which does not allow proper circulation of heat, the unit itself could simply get too hot. Refer to the installation guide to determine if the installation is within specifications.

- Burning improper fuels - this unit is designed and approved to burn only premium grade wood pellets. Burning other fuels such as cherry pits, shelled corn, or pea/rice coal is not only prohibited, the practice can lead to significant damage done to the unit in a relatively short time.
- Defective firebox sensor - test in diagnostic mode; the display should read “firebox 87F” (or higher). If the sensor’s temperature is below 87F, it will display “FIRE SENSOR UNPLUGGED OR COLD”. Use a lighter to heat up the firebox sensor briefly and observe the display for a change in the sensor’s reading. If the reading does not change, or - in the case of an over temp error is reading an extremely high number when the sensor is obviously cold - replace the sensor.

Vacuum loss:

When the stove is running, a vacuum sensor is monitoring the amount of airflow through the burn chamber. This device will stop feed if this flow is interrupted, and resume feeding when the flow is reestablished. If the airflow is interrupted for more than 30 seconds, the unit will shut down with a vacuum loss error.

Potential causes:

- Front door open/gasket leaking - the front door must remain closed to allow pressure to be registered by the vacuum switch. Also, the gasket that seals the door should make a relatively airtight seal to the face of the unit. Inspect this seal using a “dollar bill test”: With the stove off and cool, fold a dollar bill in half long-ways and insert it between the open door and the stove face, then close and latch the door. Pull on the dollar bill and note there should be resistance to the bill, caused by being pinched between the gasket and the stove face. Repeat this process in several places around the door. If the bill will slip out with no resistance, the gasket should be replaced.
- Draft (exhaust) blower not running - if the draft blower is stuck, defective or plugged up and is unable to run, the unit will not feed. The airflow generated by the draft blower activates a vacuum switch that tells the control board the front door is closed and the draft blower is pulling sufficient air through the burn pot to support the fire.
 - Solution: Clean the stove and flue system. Clean out the draft blower and check to ensure the impellor rotates freely. Check wire connections at the blower; test in diagnostic mode. If the draft blower still does not run, replace the draft (exhaust) blower.
- Improper venting method - as stated above, one of the key requirements for proper operation is proper airflow through the system. Venting systems with excessive elbows and/or long horizontal runs can restrict the flow of air to the point that the vacuum switch may not receive enough pressure to hold it closed. This would prevent feed, as the control board would assume the front door is open. Refer to the installation guide to determine if the installation is within specifications.
- Blocked flue/excessive ash buildup in stove - for airflow to be sufficient to supply enough pressure to the vacuum switch, the flue and the stove itself must be clear of blockage or excessive buildup. This situation can reduce the amount of airflow to the extent that it causes the vacuum switch to open. Proper cleaning of both the flue system and the stove must be performed on schedule to ensure the required airflow can be maintained.

- Plugged vacuum port - the vacuum pressure that is read by the switch is pulled at a small port located in the back wall of the burn chamber, to the right of the burn pot cradle. This port can become restricted or blocked by ash buildup in the mouth of the port, causing the switch to either open, or not close fully, while the stove is running. To clear this port insert a toothpick or similar implement into the mouth of the port and (gently) swirl it around while sliding it back out to ream out the opening. This port should not be vacuumed out aggressively (i.e. with any type of vacuum) as it could damage the switch.
- Defective vacuum switch - rarely does this switch fail, so all of the above issues should be ruled out before replacing this switch. The switch can be tested in diagnostic mode.

Hopper left open:

This unit has a safety switch inside the hopper that prevents the auger from running when the hopper lid is open. If the lid is left open for more than 60 seconds, the unit will shut down with this error.

Potential causes:

- Ensure the hopper lid is closing enough to engage the switch. Test in diagnostic mode; the switch can be pushed manually with the hopper open. Check the wires at the switch and control board. Test again in diagnostic; if the circuit still shows open, replace the hopper lid switch.

Diagnostic Mode for Top Mount Control Board

To enter Diagnostic Mode, the unit must be off and completely shut down.

- Press the UP , DOWN and ON buttons simultaneously, and release.
- The unit will scroll “DIAGNOSTIC MODE” followed by “REV 3.4”, for example (or whatever revision is present on the board at the time).
- Press the ON button.
 - The board will flash the LED’s of the display. This is to test that all LED’s are functional.
- Press the ON button.
 - The board will scroll “AUGER OFF” at this point. To test the auger motor, press the UP arrow. The board will then scroll “AUGER ON” and the auger motor should run continuously. To stop the auger, press the DOWN arrow, and the board will revert to scrolling “AUGER OFF” and the motor will stop. (It is recommended the burn pot be installed during this portion of the test to prevent pellets from dropping into the cradle below the burn pot).
- Press the ON button.
 - The board will scroll “DRAFT OFF” at this point. To test the draft (exhaust) blower, press the UP arrow. The board will then scroll “ DRAFT ON” and the draft blower will run at its highest output. To stop the draft blower, press the DOWN arrow, and the board will revert to scrolling “DRAFT OFF” and the blower will stop.
 - NOTE: the draft blower must be running to test the vacuum circuit later in the test, so, to leave it running, simply leave the board in the “DRAFT ON” configuration. Do not press the DOWN arrow; instead press ON button to skip to the next step leaving the draft blower running.
- Having pressed the ON button:
 - The board will scroll “ROOM AIR OFF” at this point. To test the room air (convection) blower, press the UP arrow. The board will scroll “ROOM AIR ON” and the room air blower will start running at its highest output. To stop the room air blower, press the DOWN arrow, and the board will revert to scrolling “ROOM AIR OFF” and the blower will stop.
- Press the ON button.
 - The board will scroll “IGNITER OFF”. To test the igniter, press the UP arrow. The board will then scroll “IGNITER ON” and the ignitor will energize and begin to heat up. After 3 to 4 minutes, the igniter should be at its full temperature and the glow from it should be visible in the mouth of the ignitor tube (it is recommended that the burn pot be removed during this part of the test (USE CAUTION AND NECESSARY PROTECTIVE GLOVES, GEAR, ETC.), especially if the burn pot has fuel in it from testing the auger. Also, the draft blower is running to pull air through the ignitor sleeve if all steps above were followed). To power down the igniter, press the DOWN arrow. The board will revert to scrolling “IGNITER OFF” and the ignitor will power down.
- Press the ON button.

- The board will scroll “FIRE 087F”, or whatever temperature the firebox sensor is reading at this point. The heat sensor can be tested using a lighter (or other heat producing device) to warm the sensor, and as the sensor is warmed the display will adjust to display the temperature at the sensor as it changes. If the firebox sensor is disconnected or reading below its scale, the board will scroll “FIRE SENSOR UNPLUGGED OR COLD”.
 - Press the ON button.
 - The board will scroll “ROOM 67F”, or whatever temperature the room sensor is reading at this point. The room sensor can be tested by simply holding the bulb at the end of the wire in your hand, allowing body heat to warm it. As the bulb warms up, the scrolling display will indicate a higher temperature number. If the room temp. sensor is unplugged or defective, the display will scroll “CONNECT ROOM TEMP SENSOR”.
 - Press the ON button.
 - The board will scroll “H1” or “H0”, “T1”, “V1” or “V0”, depending on the position of the hopper lid and front door.
 - The “H” indicates the status of the hopper lid switch, with “H1” meaning the lid is closed and “H0” meaning the lid is open.
 - The “T1” should always read as such, since that circuit is jumped closed and is not used on this model.
 - The “V” indicates the status of the vacuum switch, with “V1” meaning the door is closed and “V0” meaning the door is open.
 - (NOTE: the draft (exhaust) blower must be running to test this circuit).
 - To properly perform this portion of the diagnostic, read the codes as they scroll with both the front door and hopper lid closed. Then, open each, and note the scrolling readout to see if the board reflects the proper status of each switch.
 - To cycle the board back to the beginning of the diagnostic mode press the ON button; this allows the user to cycle back around to turn the draft blower off or to re-run the test, if desired.
 - To exit the test simply press the OFF button. Exiting the test can be done by pressing OFF at any point during the test. The user does not need to cycle to the end to exit, but it is recommended to cycle through and ensure each component test is set to the “OFF” status before exiting the diagnostic mode.
-

Please Note: The following section gives instructions for stove models with the Side Mount control board (where the control board is mounted on the side wall of the stove).

Please see the section of the manual “Control Board Settings – Top Mount Board” for instructions pertaining to stoves with a Top Mount control board.

CONTROL BOARD SETTINGS – SIDE MOUNT CONTROL BOARD

The control board on this stove allows the user to adjust the heat output and convection blower speed, turn the unit on and off, and test components for function (more on diagnostic mode later).

- The lower buttons on the control board (Low Fuel Feed, Low Burn Air, and Air on Temp) are not meant to be adjusted during normal operation of the unit. These buttons are factory preset and should not be adjusted by the user.
- To energize the unit and initiate a fire, press the “On” button. The LED above the button should turn green and the control board should display “S U” shortly after pressing the button.
- To shut the unit down, press the “Off” button. The LED above the button should turn red and the board should display “S d” shortly after pressing the button. This initiates the shut down sequence, and the stove will remain in shut down mode until it has cooled down.
- To increase the heat output of the stove, press the “Up” heat range button. The number in the heat range display window will increase, signifying that the control board is now adjusting the heat output to your desired level. The blower speed will increase the same amount as the heat range, because the stove is designed to operate with the blower speed greater than or equal to the heat range. Pressing the “Down” arrow will decrease the heat range and blower speed.
- To increase the blower speed without increasing the heat range, press the Blower Speed “Up” arrow until the desired blower speed is shown in the display window. Pressing the “Down” arrow will decrease the blower speed; however, the control board will not allow the blower speed to be set lower than the heat range.

Caution

This unit is meant to operate only with the main viewing door closed. Smoke spillage and an inefficient, lazy burn will result from attempting to operate the stove with the door open.

In addition, using fuel other than wood pellets can create an unsafe situation and can also generate excess carbon monoxide. Carbon monoxide is an odorless, colorless gas which can be deadly. Be sure to burn only wood pellets.

The use of a carbon monoxide detector is strongly recommended.

ERROR CODES – SIDE MOUNT CONTROL BOARD

Error codes, or “E-Codes,” are alphanumeric codes that will appear in the Heat Range and Blower Speed windows of the Control Board if the unit experiences an abnormal condition. Error codes are the control board’s way of telling the user that something isn’t operating correctly within the stove, and that the unit should be carefully inspected before reigniting. See the “Trouble-Shooting Guide,” page 41, for additional information on error codes.

E-0

- When this is displayed in the control board windows (typically when restarting after an “E-Code” shutdown), it means there are currently no errors and the stove will begin normal operation.

E-1

- This error code is not used on this stove. If it is displayed in the control board windows, please contact Technical Support and they will diagnose the cause of the false code.

E-2

- When this code is displayed in the control board window it indicates a failure to light. Although the stove may have ignited the pellets, the control board did not register a high enough temperature to determine the fire was lit. If a fire was ignited, wait for the unit to cool, clean the burn pot and restart the unit.

E-3

- This error code indicates the preset maximum allowable exhaust temperature was exceeded. Commonly referred to as “Over-Firing,” the E-3 code means something in the stove is causing the exhaust gas to be hotter than expected.

E-4

- This code is displayed based on a drop in the exhaust temperature. This code means the fire or “proof of flame” has been lost. It usually results from the hopper being empty.

If an error code continues to display, if the error code seems unexplainable, or if you have any other questions about error codes and what they mean, please contact Technical Support at (877) 356-6663.

Hopper Lid Safety Switch - This unit is also equipped with a hopper lid safety switch (Part # AC-HLSB) which is directly connected to the auger motor. In the event the hopper lid is left open while the stove is in operation, the hopper lid switch will prevent the auger from turning. This is to prevent byproducts of combustion from entering the home through the open hopper lid and also to simply prevent operation with the hopper lid open. Improper hopper lid safety switch operation will result in an auger that will not turn and therefore a stove that will not burn. NEVER place your hand or any object near the auger while the stove is connected to power.

POWER FAILURE – Top and Side Mount Control Boards

If the power to the unit is interrupted for approximately three minutes or less, the unit will resume operation when power is restored according to the following table:

Unit's State Before Power Loss	State When Power Returns
ON	Warmup (Start-Up)
Warmup (Start-Up)	Warmup (Start-Up)
Shut-Down	Shut-Down
OFF	OFF

- If the power is interrupted for more than (approximately) three minutes, the unit will be "OFF" when power returns.
- **IMPORTANT** – Do **NOT** open the hopper lid or the door to the unit during a power outage. Open the closest outside door and a window to reduce the chance of any combustion byproducts entering the home from the stove. Wait for the power to be restored and then press the "ON" button to restart the unit, if necessary.

Smoke Detectors

Englander highly recommends the use of smoke detectors in every room of the house. However, locating a smoke detector directly above this unit can result in nuisance alarms.

Caution – Shock Hazard

Press the "Off" button and let the appliance completely cool BEFORE unplugging the appliance and beginning any maintenance or component replacement.

Risk of shock if appliance is not unplugged before service

****Failure to properly clean your stove can cause poor performance and possibly a burn back!****

DAILY MAINTENANCE

Disposal of Ashes – Ashes should be placed in a metal container with a tight fitting lid. The closed container of ashes should be placed on a noncombustible floor or on the ground, well away from all combustible materials, pending final disposal. If the ashes are disposed of by burial in soil or otherwise locally dispersed, they should be retained in the closed container until all cinders have been thoroughly cooled.

Important Notes

- As with any maintenance concerning this unit, be sure the unit is “OFF” and has completed the Shut-Down cycle **BEFORE** beginning.
- Be aware that metal parts in the firebox can remain **HOT** long after the fire has gone out and **EVEN** after the Shut-Down cycle is complete. Always use extreme caution when handling potentially hot stove parts, even if you think they should be cold.
- Ashes should only be removed when the stove has been shutdown and has been allowed to cool thoroughly. Hot embers can remain under ashes long after the fire has gone out, so always be extra careful when handling any ashes from this (or any) stove.
- Different pellets will generate varying amounts of ash and burn pot deposits. Carefully monitor the ash build up in the stove when first operating the unit, as well as whenever a different brand of pellets is burned.
- While the amount of ashes generated by this unit is not excessive compared to a traditional log-burning woodstove, keeping the unit clean and free of ash is **ESSENTIAL** for peak performance and maximum efficiency. Ash build-up hampers airflow, reduces efficiency, and can cause a smoke back.
- Englander is not responsible for any damages incurred due to a poorly maintained and/or dirty stove. This pellet stove is a highly efficient machine and, as such, requires sufficient maintenance to keep it operating at its peak.

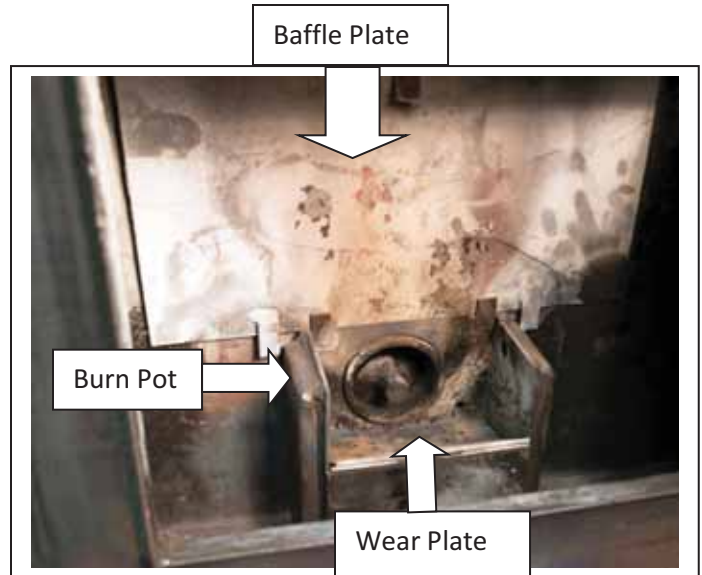

Ash Removal and Disposal (at least twice per week)

- Press the “Off” button and allow the stove to complete the shutdown cycle and cool completely.
- A long-handled screwdriver or long-handled putty knife can be used to scrape any build-up or crust into the burn pot area. This can then be pushed left or right into the ash storage area.
- Remove the ashes with a scoop. Follow the “Disposal of Ashes” instructions listed above (under Daily Maintenance).

Cleaning the Burn Pot

Along with removing ashes from the stove, cleaning the burn pot is the other essential part of daily maintenance that will keep the stove operating at its peak. Pellets contain varying amounts of impurities and fusible material that will accumulate in the burn pot over time. Some pellets will contain much higher amounts of these fusible impurities, therefore extra vigilance may be required to maintain a clean burn pot. Allowing impurities to build up in the burn pot can restrict the air flow to the fire, resulting in a dirty, inefficient burn and can shorten the life of the burn pot.

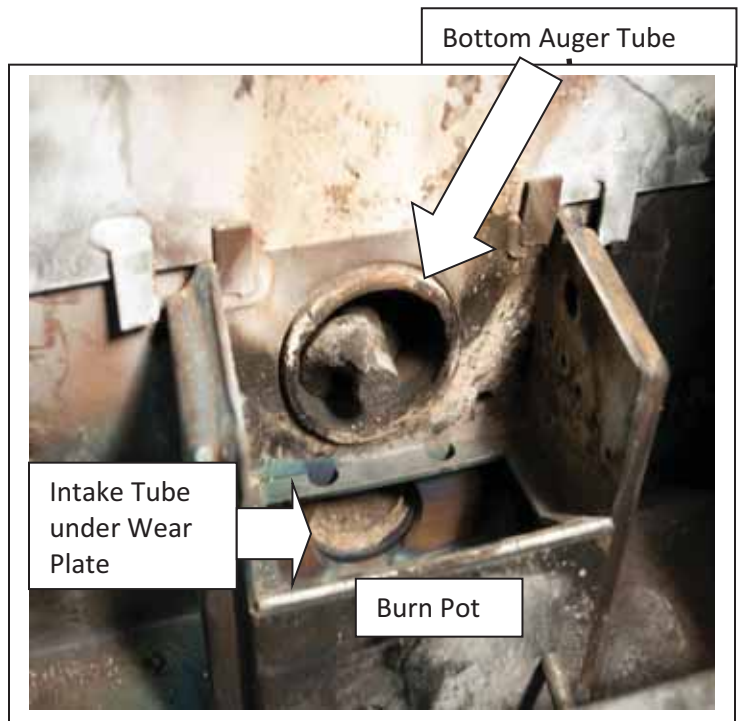

NOTE: The burn pot should actually be cleaned out **before each start-up** (before pressing the ON button), and daily.

- Always allow the stove to finish the shut-down cycle and cool completely before performing any maintenance inside the firebox.
- Open the front door to access the burn pot. **WARNING** – The burn pot can remain HOT long after the fire has gone out, so wear protective gloves whenever handling a potentially hot burn pot, if you remove it.
- Remove and clean the burn pot wear plate (refer to the exploded diagram in the rear of this manual, and the diagram on the previous page).
- Remove any ash build-up in the area below the wear plate. Also, be sure there are no ashes or obstructions in the intake tube under the wear plate. **IMPORTANT: Ash build-up under the wear plate can cause the unit to malfunction.**
- Check for any build-up in the front of the burn area. Clean out all air holes in the wear plate (if necessary, a 1/8" drill bit can be used) --these air holes should be kept clean, as they supply combustion air under and around the pellet fuel.
- The burn pot assembly should also be thoroughly cleaned, including the burn box. When replacing the wear plate, ensure that it lies flat in the firebox and no gaps (from ash residue) are under it. Insert the burn pot back into the cradle if you have removed the entire burn pot, and be sure to tighten the set screws, but do not over-tighten them.

WEEKLY MAINTENANCE

Baffle Removal

- As with any maintenance concerning this unit, be sure the unit is “OFF,” has completed the Shut-Down cycle, and is completely cool BEFORE beginning. Be aware that metal parts in the firebox can remain HOT long after the fire has gone out and EVEN after the Shut-Down cycle is complete. Always use extreme caution when handling potentially hot stove parts, even if you think they should be cold.
- Weekly maintenance should include the steps listed in this section AS WELL AS the steps listed in the “Daily Maintenance” section.
- The large baffle plate that rests above and behind the burn pot (refer to the exploded diagram in the rear of this manual and the images in the Daily Maintenance section) should be removed weekly. This can be done by lifting up the plate and pulling it out. The area behind the plate should then be cleaned thoroughly, and the plate placed back in the original position.
- Use a screwdriver or chisel and break any creosote build-up in the front of the unit, where the pellets are fed into the burn pot from the Bottom Auger Tube (see Illustration in previous section). Moisture in the pellets and resulting build-up in this area can cause the bottom auger to “squeal” or squeak.
- Carbon Removal: During normal operation carbon from the combustion of pellet fuel will tend to build up on the tip of the auger, on the wear plate and sides of the fire pot, and in the mouth of the feed tube. It is essential that this residue be removed to ensure trouble free operation of the unit. The frequency with which this carbon must be removed varies with brands of pellets, depending on moisture content, wood type, foreign material (dirt, etc.) in pellets, and other factors.
- To remove this carbon, simply scrape it off using the blade of a flat tipped screwdriver or similar instrument; also, to remove carbon from the feed tube, scrape as much as can be easily reached, then insert an emery board (fingernail file made from a popsicle stick and sandpaper) between the feed auger and the feed tube and sand out any residue not removed from scraping alone. Clearing this carbon residue from the feed tube is essential for proper operation of the feed auger, which is designed to float freely in the feed tube allowing smooth fuel flow, a lesser possibility of a jam, and a quieter unit.
- Replace the baffle by reversing the above steps.
- If excess ash accumulation is found in the exhaust chamber or venting system during monthly maintenance, the interval between cleanings should be reduced to eliminate the possibility of poor stove performance due to ash accumulation.
- A specially designed ash vacuum and pellet stove cleaning kit is available from the Englander website; please see: englander-stoves.com

MONTHLY MAINTENANCE

A good rule of thumb for monthly maintenance is that it should be done each time an entire ton of pellets is burned **OR** once per month, whichever comes first.

Venting Pipe Cleaning

- Low spots and direction changes in the venting system (such as tees and elbows) are areas for potential fly-ash and creosote accumulation. **INSPECT** these areas diligently to keep the venting system in safe operating condition.
- Depending on the specific type of venting system your stove is connected to, it may be possible to remove the clean-out tee cover and simply run a pipe brush up the pipe to remove any fly-ash accumulation.
- Horizontal runs of pipe, such as from the exhaust connection on the stove to the vertical transition, will accumulate fly ash and should be inspected carefully and brushed clean.
- Check the termination cap to be certain it is not clogged or restricted by any fly-ash accumulation.
- After thoroughly cleaning the venting system, reseal any disassembled seams with high temperature silicone (Part # AC-RTV3) if applicable to your venting system.
- Inspect seams that were not disassembled to be certain a smoke-tight seal is still being made.
- After prolonged use, leaks in the venting system can usually be found by searching for fly-ash deposits on the outside of the pipe. Carefully check for leaks in the venting system and seal them accordingly.
- Although most pellet venting systems are designed to last a lifetime, pellet fly-ash can be corrosive under certain conditions. When cleaning your venting system, examine the pipe carefully for any signs of deterioration and replace sections that show excessive wear. It is unlikely that this will ever be a concern, but maintaining your venting system in safe operating condition is crucial to safe stove operation.

YEARLY MAINTENANCE

Important Notes

- As with any maintenance concerning this unit, be sure the unit is “OFF,” has completed the Shut-Down cycle, and is completely cool BEFORE beginning.
- Be aware that metal parts in the firebox can remain HOT long after the fire has gone out and EVEN after the Shut-Down cycle is complete. Always use extreme caution when handling potentially hot stove parts, even if you think they should be cold.
- Yearly (or end of season) maintenance should include the steps listed in this section AS WELL AS the steps listed in the “Daily Maintenance,” “Weekly Maintenance” and “Monthly Maintenance” sections of this manual.
- Yearly maintenance should be performed at the end of the burning season. Leaving ash and other build-up in the stove during the non-heating months can lead to premature metal degradation in the stove and venting system. Using extra attention to detail and being certain to be very thorough in the end of season cleaning will help increase the operating life of the stove and venting system.
- The unit should be unplugged during the summer months (and periods of non-use), to help protect against the possibility of damage due to lightning strikes and other power disruptions.

SOOT AND FLY ASH: FORMATION AND NEED FOR REMOVAL

The products of combustion will contain small particles of fly ash. The fly ash will collect in the exhaust venting system and restrict the flow of the flue gases. Incomplete combustion, such as that which occurs during startup, shutdown or incorrect operation of the room heater will lead to some soot formation which will collect in the exhaust venting system. The exhaust venting system should be thoroughly inspected at least once every year to determine if cleaning is necessary.

Caution – Shock Hazard

Press the “Off” button and let the appliance completely cool BEFORE unplugging the appliance and beginning any maintenance or component replacement.

Risk of shock if appliance is not unplugged before service.

YEARLY MAINTENANCE

- The stove and the flue system should be given a complete cleaning at the end of the heating season.
- **Burn Pot:** Remove the burn pot assembly, clean it thoroughly, and re-install it (refer to Exploded Parts Diagram in the rear of this manual and the Daily Maintenance section); this will require new gasket for the burn pot. Be sure to tighten the set screws when you replace them, but do not over-tighten.
- **Combustion (Exhaust) Blower Cleaning:** Although the combustion blower and blower housing were designed to minimize ash build-up, some fly-ash will still accumulate there throughout the burning season. The amount and type of ash will depend on the type of pellets and venting system, but generally this accumulation will be mild. If, when cleaning the combustion blower, a large accumulation of fly-ash is found, cleaning the blower and housing should be performed monthly or bimonthly to prevent this excess buildup.

Instructions

- Before beginning the combustion blower cleaning procedure, be certain the unit is unplugged and thoroughly cooled down.
- Disconnect the venting system from the combustion blower just enough that you will be able to remove the blower from the stove.
- Remove the left side access panel, using a 5/16" wrench.
- Remove the back panel of the unit, using a 5/16" wrench.
- Unplug the two power leads to the combustion blower, using the quick connect plugs.
- Loosen the five (5) 5/16" self-drilling screws which hold the combustion blower to the blower tube.
- Lift the combustion blower up and out of the stove. The gasket which seals the blower to the blower tube is fragile, so take extra care when removing the blower. Even when being careful, though, it is easy to tear this fragile gasket, and since an airtight seal is crucial here, you should replace this gasket (Part # - PU-CBMG) every time the combustion blower is removed. Remove the gasket with a putty knife, and install the new gasket by applying adhesive to the blower and installing the new gasket (instructions and adhesive are provided with the gasket).
- With the combustion blower removed, use a utility vacuum to remove any ash accumulation in the combustion blower tube on the stove.
- Using a soft paint brush, carefully remove any ash accumulation from the inside of the combustion blower, and from the blower fan blade.
- Inspect the combustion blower motor for dust accumulation and carefully remove it, ensuring that all air cooling holes into the motor are open and free of dust deposits.
- Install the blower in the reverse order as described above. Remember to check the condition of the combustion blower gasket, and to reconnect the two wires which connect the blower to the stove's control board.

- Reinstall the venting system and panels.
- NOTE: As an option, there is a Combustion Motor Gasket that is included with Part # PU-CBMG, which allows you to remove the motor (only) from the combustion blower housing, clean the motor and inside of the blower housing, and replace the motor and its gasket without having to remove the entire Combustion Blower. Remember that the blower impeller, blower tube and steel blower exhaust tube on the stove should be brushed and vacuumed.

Convection Blower Cleaning

- As always, be certain the stove is cool and unplugged before servicing any components within the unit. Since the convection blower does not handle any by-products of combustion, it does not require serious cleaning like the exhaust blower.
- However, dust from the home and other debris in the air can accumulate on the blades of the convection blower. Any dust that has built up on the fan blades can usually be easily removed with a vacuum or a soft paint brush.
- The back panel will need to be removed from the stove, using a 5/16" wrench.
- The control (circuit) board will need to be removed, by removing the two 5/16" screws and pulling the control board out of the stove. Some wire ties may need to be cut so that the board can be pulled out of the way of the blower (remember to replace them).
- Four 5/16" screws will need to be removed in order to remove the convection blower from the stove. You will likely need a socket with a long extension.
- Install the blower in the reverse order as described above.
- Also see the Convection Blower removal instructions in the Replacing Components section of the manual.

FINISH

- This new unit has been painted with High-Temperature paint that should retain its original look for years.
- If the unit should get wet and rust spots appear, the spots can be sanded with fine steel wool and repainted. It is crucial that only High-Temperature Spray Paint is used (Part# AC-MBSP), as others may not adhere to the surface or withstand the high temperatures.
- Similarly, some brands of paint will not adhere to different brands of paint, so we highly recommend using our proprietary High-Temperature Spray Paint.

GASKETS

- Gaskets should be inspected and replaced annually. See the Gaskets page in Replacing Components (page 49) for information and instructions.

Trouble-Shooting Guide

WARNING: To avoid **ELECTRICAL SHOCK** always *disconnect* the unit from the power source **BEFORE** attempting any repair. If this guide does not correct the problem, call Technical Support at 1-877-356-6663.

*See ERROR CODES section earlier in this manual for information on troubleshooting Error Codes

<u>Problem</u>	<u>Cause</u>	<u>Solution</u>
Top Auger not turning	<ol style="list-style-type: none"> 1. Bad auger motor. 2. Foreign matter jamming auger. 3. Vacuum sensor. 4. Hopper lid switch 	<ol style="list-style-type: none"> 1. Replace auger motor. 2. Remove pellets and object. 3. Check exhaust blower. 4. Make sure hopper lid is closed/replace switch
Bottom Auger not turning	<ol style="list-style-type: none"> 1. Bad auger motor. 2. Foreign matter jamming auger. 	<ol style="list-style-type: none"> 1. Replace auger motor. 2. Remove pellets and object.
Smoke smell or dust in house	<ol style="list-style-type: none"> 1. Improper exhaust connection. 	<ol style="list-style-type: none"> 1. Check exhaust connections for leaks, especially the exhaust blower connect. Seal leaks with silicone, aluminum tape or a hose clamp.
Room blower not operating	<ol style="list-style-type: none"> 1. Loose thermal sensor. 2. Blower speed set higher than heat range, causing stove to cool and blower to cycle. 3. Loose connection. 	<ol style="list-style-type: none"> 1. Tighten connection on sensor. 2. Lower blower speed. 3. Check control board connection.
Exhaust blower not operating	<ol style="list-style-type: none"> 1. Loose connection. 2. Bad blower. 3. Bad vacuum sensor. 	<ol style="list-style-type: none"> 1. Check control board connection. 2. Replace blower. 3. Replace vacuum sensor.
Lazy Fire	<ol style="list-style-type: none"> 1. Bad exhaust blower. 2. Excessive pellet moisture. 3. Excessive ash build-up. 4. Low quality pellets. 	<ol style="list-style-type: none"> 1. Inspect and replace blower. 2. Keep pellets dry. 3. Thoroughly clean unit. 4. Use only PFI premium pellets.
Blown Fuse	<ol style="list-style-type: none"> 1. Power surge. 2. Exposed wire. 3. Electrical component shorting. 	<ol style="list-style-type: none"> 1. Replace fuse; use surge protector. 2. Check for exposed or frayed wire and loose connections. 3. Check motors and blowers for obstructions or short circuits.
High Pellet Consumption	<ol style="list-style-type: none"> 1. Low quality or non-uniformly sized pellets. 	<ol style="list-style-type: none"> 1. Use premium pellets or try another pellet brand.
Squeaking Noise	<ol style="list-style-type: none"> 1. Obstruction in auger tube. 2. Blower Noise. 	<ol style="list-style-type: none"> 1. Check auger tube for foreign objects. 2. Remove, clean, and oil blower.
Pinging or Rattling Noise	<ol style="list-style-type: none"> 1. Foreign material in blower. 2. Loose exhaust fan set screw. 	<ol style="list-style-type: none"> 1. Check both blowers for material. 2. Check set screw for tightness.

IMPORTANT! READ AND FOLLOW ALL INSTALLATION AND MAINTENANCE INSTRUCTIONS, INCLUDING CLEANING THE UNIT AS SPECIFIED, AND REPLACING GASKETS ANNUALLY, AND PARTS AS NEEDED.
ENGLANDER IS NOT RESPONSIBLE FOR ANY DAMAGE OR INJURY INCURRED DUE TO NEGLIGENCE, OR DUE TO UNSAFE INSTALLATION OR USAGE OF THIS PRODUCT. CALL TECHNICAL SUPPORT WITH ANY QUESTIONS.

Error codes related only to side mounted control board

Unit Shuts Down in 15-20 minutes with an "FS" code (Top Mount) or "E-2" code (Side Mount) on control board. (Failed Start)	<ol style="list-style-type: none"> 1. Loose thermal sensor. 2. Control board settings. 3. Failure to light pellets. 	<ol style="list-style-type: none"> 1. Check both sides of thermal sensor connection (exhaust blower and control board). 2. Start stove on minimum Heat Range 5 to ensure a good fire is started. 3. Check igniter for buildup or failure.
"OT" Code (Top Mount) or "E-3" Code (Side Mount) on Control Board (OverTemp)	<ol style="list-style-type: none"> 1. Convection (Room Air) blower failure. 2. Partially blocked flue. 3. Using fuel other than premium wood pellets. 	<ol style="list-style-type: none"> 1. Check convection blower for proper function, replace if necessary. 2. Check flue for obstructions. 3. Use ONLY premium wood pellets in this stove.

Notes:

1. Whenever instructed to check/replace the vacuum sensor, also check for loose or cracked vacuum hose. Also, be certain the vacuum measurement port in the firebox is kept clean (clean with a pipe cleaner or brush, **do not use a vacuum** to clean this port).
2. To restart and clear an error code displayed on the control board, push the "ON" button and the unit should reset the error and restart.
3. If you are uncertain about the meaning of an error code or have any questions at all, **PLEASE** contact Technical Support at (877)356-6663.

IMPORTANT SAFETY NOTE: If the unit or chimney connector pipe “glows” red (or white), the stove is over-fired. This condition could cause a house or chimney fire. Do not operate your unit too hot, or over-firing may result.

REPLACING COMPONENTS

See Exploded Diagram at rear of manual for parts reference
englander-stoves.com Questions: (877) 356-6663

Convection (Room Air) Blower

- Before beginning any component replacement, be certain the unit is unplugged and thoroughly cooled down.
- Remove the back panel of the unit, using a 5/16" wrench.
- If it is a side-mount control board, the control (circuit) board may need to be removed, by removing the two 5/16" screws and pulling the control board out of the stove. Some wire ties may need to be cut so that the board can be pulled out of the way of the blower (remember to replace them).
- Locate and detach the power leads to the convection blower.
- Using a socket with a long extension, loosen and remove the (4) 5/16" screws which hold the blower to the stove; remove the blower from the stove.
- Installation of the new blower is performed in reverse of removal; remember to reconnect the power leads to the blower, and replace any wire ties before reinstalling the control board. (When installing the new blower, place the blower motor opening pointing UP, towards the top of the stove.)
- Visit youtube.com/heatredefined for detailed service 'how to' videos.

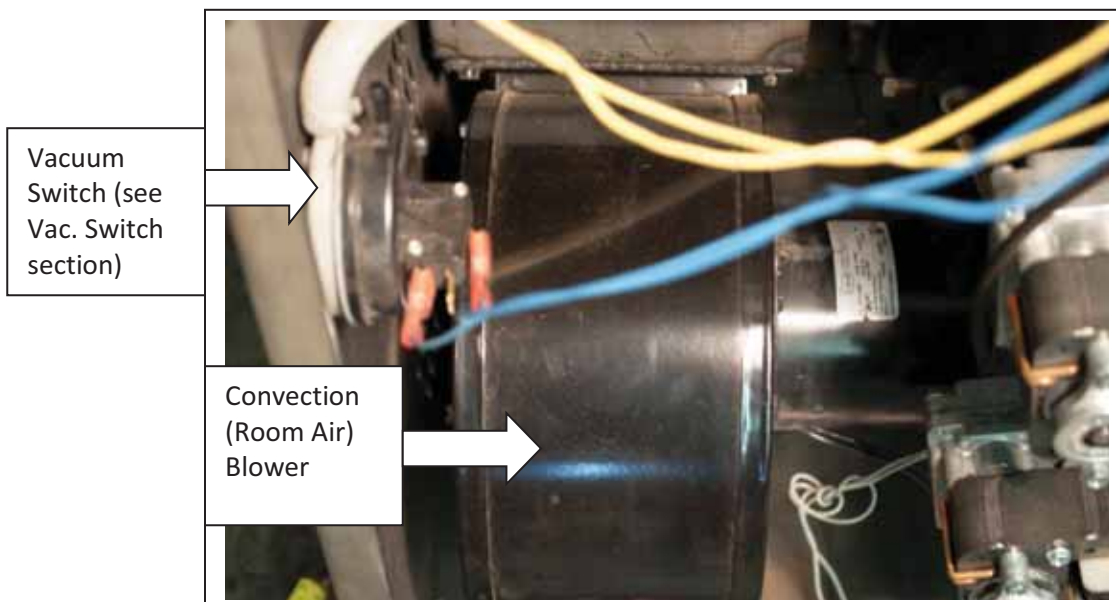

Auger Motors, Bearings & Shafts

- Before beginning any component replacement, be certain the unit is unplugged and thoroughly cooled down. Also, make sure the hopper is empty before attempting to remove or replace the top auger motor assembly.
- Remove the back panel of the unit, using a $\frac{5}{16}$ " wrench.
- Before loosening any auger motor bolts, detach the power leads from the auger motor.
- Locate the appropriate auger motor assembly at the rear of the stove, loosen the $\frac{5}{16}$ " square head set bolt that is positioned between the auger motor and the auger block bearing. This bolt tightens down on the flat side of the gear shaft, and locks the gear shaft and auger shaft together.
- Once the bolt is loosened, the assembly will slide from the locking collar and auger shaft.
- To replace the top auger, all pellet fuel must be removed from the hopper as well as from the top auger assembly.
- Once this is done, the four $\frac{1}{2}$ " bolts that hold in the bearing can be removed, and the complete auger assembly may be removed from the stove.
- The auger bearings are a sealed unit and do not require lubrication.
- Remove the $\frac{3}{4}$ " shaft collar from the auger shaft/bearing assembly.
- Loosen the two (2) $\frac{1}{8}$ " set screws on the end of the auger bearing with a $\frac{1}{8}$ " Allen wrench, which will disconnect the bearing from the shaft (the bearing assembly and auger assembly can be replaced by reversing this procedure; pull the bearing flush against the $\frac{3}{4}$ " collar before tightening the two $\frac{1}{8}$ " set screws).
- Be sure to install a new auger bearing gasket when replacing an auger bearing.

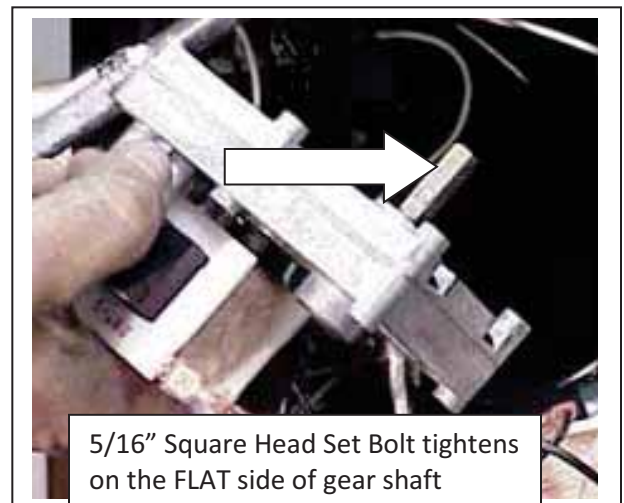
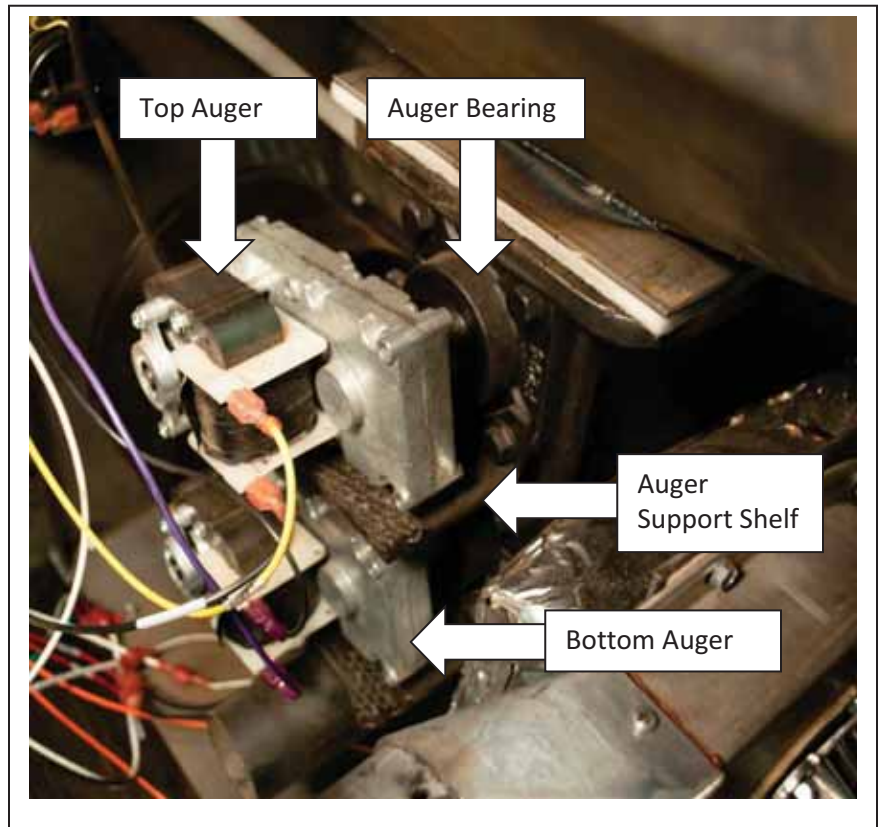

- When placing the auger assembly in the unit, always tighten the four auger bearing bolts in a diagonal (criss-cross) pattern to ensure the bearings and shafts are aligned properly. Remember to install the auger shelf support, placing the two bottom bolts through the shelf and the auger bearing.
- NOTE: Follow the same procedure to work on the bottom auger, with the exception that the pellets do not necessarily have to be removed from the hopper.
- Visit [youtube.com/heatredefined](https://www.youtube.com/heatredefined) for detailed service 'how to' videos.

Combustion (Exhaust) Blower

- Before beginning any component replacement, be certain the unit is unplugged and thoroughly cooled down.
- Disconnect the pellet vent pipe so that the combustion blower may be accessed.
- Remove the left side access panel, using a 5/16" wrench..
- Remove the back panel of the unit, using a 5/16" wrench.
- Disconnect the power leads to the combustion blower.
- Remove all (5) screws which hold the exhaust blower to the exhaust blower tube. Once the screws have been removed, the blower can be lifted up and out of the stove.
- Replace the combustion blower gasket each time you remove the blower from the stove (Part # PU-CBMG). Remove the gasket with a putty knife, and install the new gasket by applying adhesive to the blower flange and installing the new gasket (instructions and adhesive are provided with the gasket).
- Reinstallation is the exact opposite of the steps above.
- Visit [youtube.com/heatredefined](https://www.youtube.com/heatredefined) for detailed service 'how to' videos.

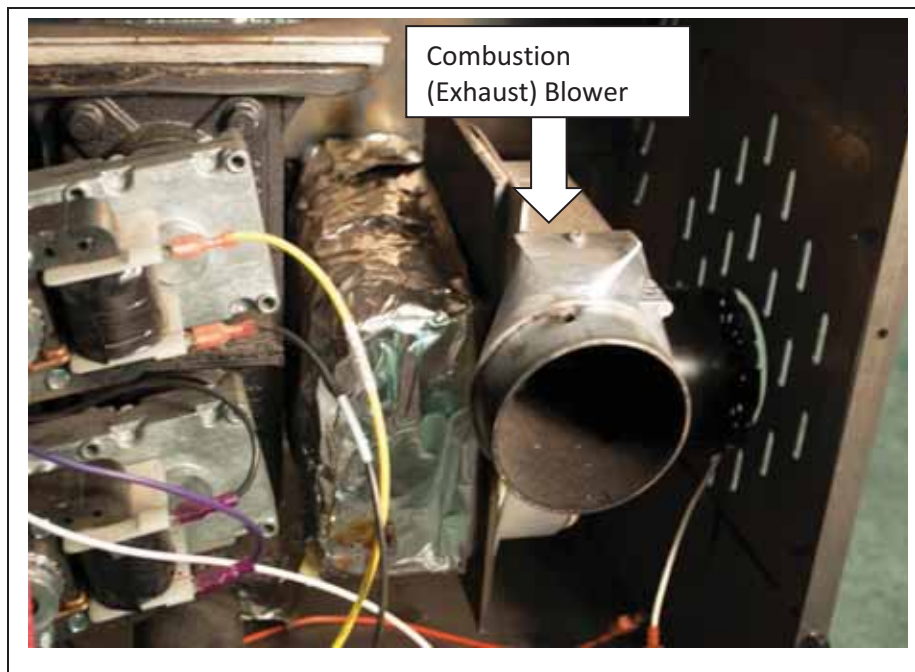

REPLACING COMPONENTS

Vacuum Switch - Function

- This unit is equipped with a Vacuum Shut Down Switch (Part # CU-VS), which helps control various functions of the unit.
- If an operational error occurs in the unit, a switch will either stop the top (feed) auger or shut the unit off; if the unit turns off an error code will appear on the Control Board.
- Situations which could cause this include power failure, Combustion Blower failure, improper flue installation, a blocked flue (from rodents, nests, etc.), or “dirty burning” from burning improper fuel (see “Important Information” at the beginning of the manual).

Vacuum Switch Port

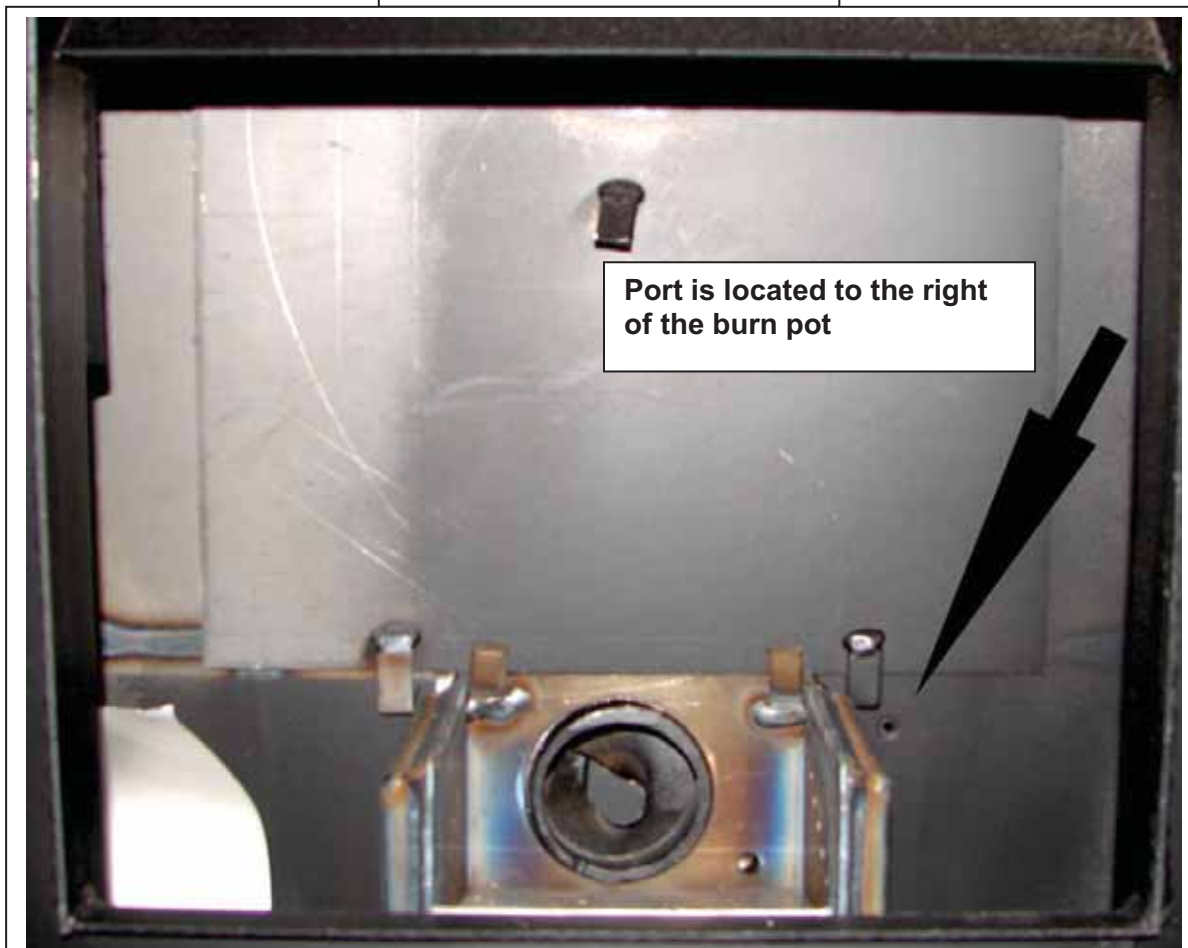

NOTE: The vacuum switch port must be kept clean, or the top auger will cease to function. Locate the port hole to the right of the burn pot and, with the stove unplugged and cooled down, use a brush or pipe cleaner (not a vacuum) to keep this port clear of ash or other debris (see picture).

REPLACING COMPONENTS

Vacuum Switch

- Before beginning any component replacement, be certain the unit is unplugged and thoroughly cooled down.
- Remove the back panel of the unit, using a 5/16" wrench.
- Locate the vacuum switch as shown in the diagram below (on the left wall of the unit).
- Disconnect the power leads and vacuum hose from the vacuum switch, *taking note of where connections were made.*
- Remove the (2) screws which hold the vacuum switch to the vacuum switch bracket, using a Phillips screw driver.
- Installation is the reverse of removal; be absolutely certain the wires and vacuum hose are connected as they previously were (and according to the wiring diagram in this manual).
- Visit [youtube.com/heatredefined](https://www.youtube.com/heatredefined) for detailed service 'how to' videos.

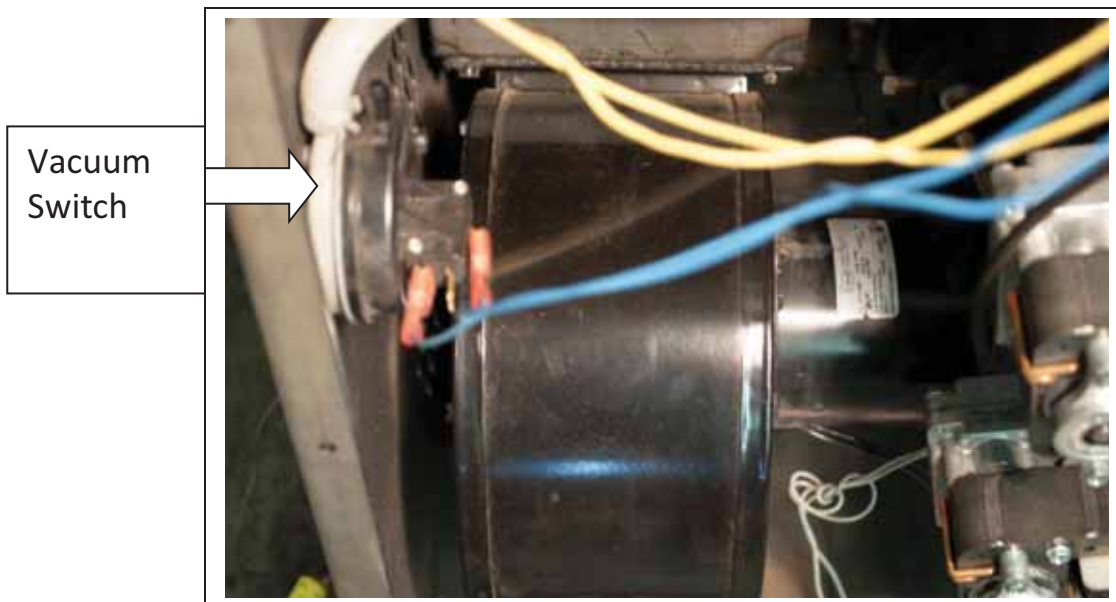
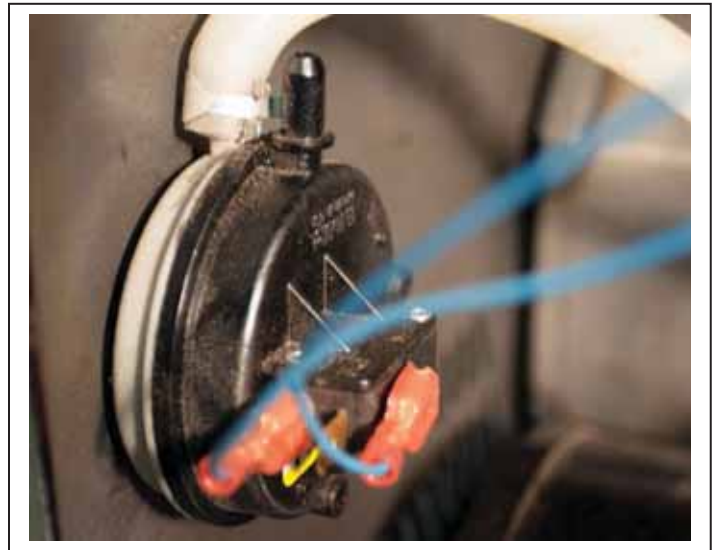

REPLACING COMPONENTS

Igniter

- Before beginning any component replacement, be certain the unit is unplugged and thoroughly cooled down.
- Remove the back panel of the unit, using a 5/16" wrench.
- Locate the igniter on the left side of the feeder assembly (as viewed from the rear of the unit).
- Disconnect the power leads to the igniter.
- Loosen the 5/16" square head set screw from the igniter tube and remove the old igniter cartridge (your unit may have Allen set screw which needs a 1/8" Allen wrench).
- Install the new igniter in the igniter tube, being sure the igniter is flush with the back of the housing.
- Retighten the set screw and remember to reconnect the power leads.
- Reinstall the rear panel.
- See [youtube.com/heatredefined](https://www.youtube.com/heatredefined) for a service video that shows how to replace the igniter.

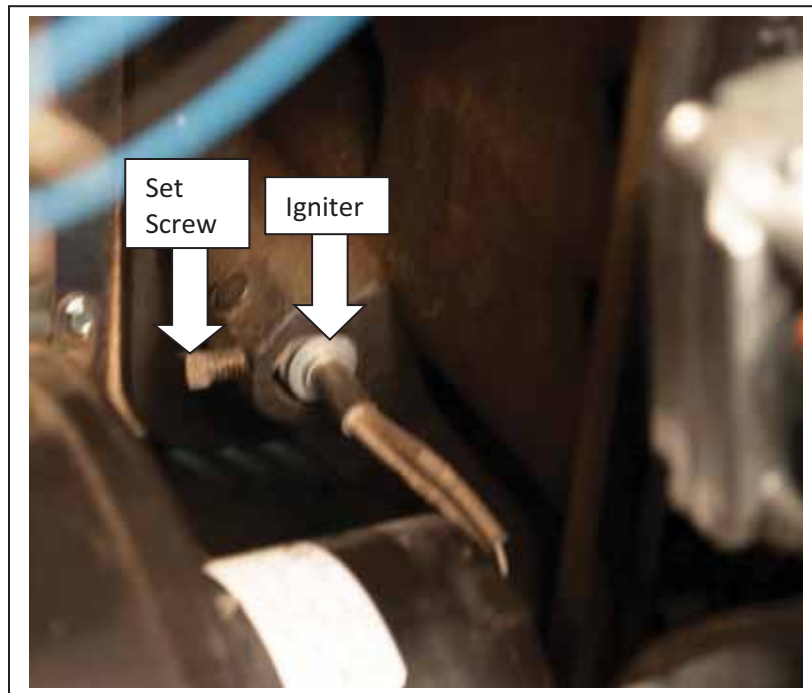

REPLACING COMPONENTS

IMPROPER GASKET MAINTENANCE, INCLUDING FAILURE TO REPLACE GASKETS,
CAN CAUSE AIR LEAKS RESULTING IN SMOKE-BACKS.
IT IS MANDATORY TO REPLACE GASKETS ANNUALLY.

Gaskets

1. Door

- This unit comes with a $\frac{3}{4}$ " rope gasket in the channel around the door opening that should be replaced at least once every year. To replace the door gasket (Part # AC-DGKHD), the old gasket must first be removed entirely — prior to adding the new adhesive, you may have to scrape the old cement from the channel. Once the cement and gasket have been added, the door should be closed and latched for twenty-four hours to allow the cement to harden. See next page for more info.

2. Window

- If you are replacing the window gasket (Part # AC-GGK), the new gasket will already have adhesive on one side. Remove the paper on the adhesive side and place the gasket around the outside edge of the glass, centered over the edge. Fold the gasket edges over on the glass, forming a "U" shape.

3. Combustion Blower

- The Combustion Blower Gasket (Part # PU-CBMG) should be replaced whenever you remove or clean the Combustion Blower assembly.
- Remove the gasket with a putty knife, and install the new gasket by applying adhesive to the blower flange and installing the new gasket (instructions and adhesive are provided with the gasket).

4. Combustion Blower Motor

- The combustion blower motor gasket (Part # PU-CBMG) generally does not need replacement, as it is not normally removed from the unit. However, if the exhaust blower is cleaned by removing only the motor, rather than the entire blower assembly, this gasket must be inspected and replaced as necessary.

REPLACING COMPONENTS

Glass

This unit has one ceramic glass panel (Part # AC-G9) in the door; self adhesive window gasket is included with replacement windows purchased directly from Englander. Never replace ceramic glass with tempered or any other type of glass and never operate this unit with cracked or broken glass. Surface scratches are acceptable and normal, but if this glass becomes cracked in any area, the unit should be shut down and the glass replaced with this high-temperature ceramic glass.

Ceramic Glass Specifications

- Glass Size: 9.125 in. (231.78 mm) x 9.125 in. (231.78 mm)
- Glass Type: 5mm Ceramic Glass

Glass Precautions

- Never replace ceramic glass with tempered or any other type of glass.
- Never operate this unit with cracked or broken glass.
- Do not slam the door or strike the glass with any objects.

Glass Cleaning

1. Be certain the stove is Off, and the stove **and** the glass are completely cool.
2. The build-up on the glass will generally be light and water is normally sufficient to remove the deposits. If stubborn soot persists, use a cleaner made specifically for this purpose. Do not scrape the glass or use abrasive cleaners.
3. Rinse the glass with clean water and dry the glass before resuming normal operation.

Glass Replacement (includes Door Gasket replacement instructions)

1. Remove the door from the stove and rest it face-down on a firm work surface.
2. Remove the door gasket using a pair of pliers to pull it out of the channel.
3. Using a $\frac{5}{16}$ " wrench, remove the (4) screws that hold the glass tabs in place on the door.
4. Lift the old glass panel out and discard (be especially careful if the old glass is broken or cracked).
5. The new glass panel must be wrapped with a self-adhesive fiberglass tape gasket (Part # AC-GGK). This gasket serves to cushion the glass from the steel door and brackets.
6. Reinstall the glass tabs using the screws previously removed. Do not over-tighten the screws.
7. Install the new door gasket (Part# AC-DGKHD) using the provided high temperature adhesive.
8. Hang the door back on the stove and close tightly and allow 24 hours for adhesive to cure.

See diagram on page 56 for door assembly.

REPLACING COMPONENTS

Top Mounted Control Board

BEFORE REPLACING THE CONTROL BOARD BE SURE THE UNIT IS COOLED COMPLETELY AND UNPLUGGED.

The Control Board (Part # PU-CB14) is a digital read-out board. To replace the control board, first unplug the power cord from the wall outlet. Remove the front face of the control board by pulling it forward. Once the board is apart, use a pair of needle nose pliers to disconnect the wiring harness, room sensor, thermostat, hopper lid and vacuum switch connectors.

When connecting the new board, reconnect the components mentioned above and snap the front face of the control panel back into place. Reconnect power when ready to use the unit.

Recommended Heat Ranges (For Manual Mode):

Low Burn:	Heat Range setting: 1	Room Air Blower setting: 1
Medium Low:	Heat Range setting: 2 – 3	Room Air Blower setting: *
Medium High:	Heat Range setting: 4 – 8	Room Air Blower setting: *
High Burn:	Heat Range setting: 9	Room Air Blower setting: 9

* *NOTE:* Blower Speed will automatically be adjusted to the desired Heat Range that you select.



Note: The overlay on your unit may vary in appearance.

Control Board Wiring – Top Mount Control Board

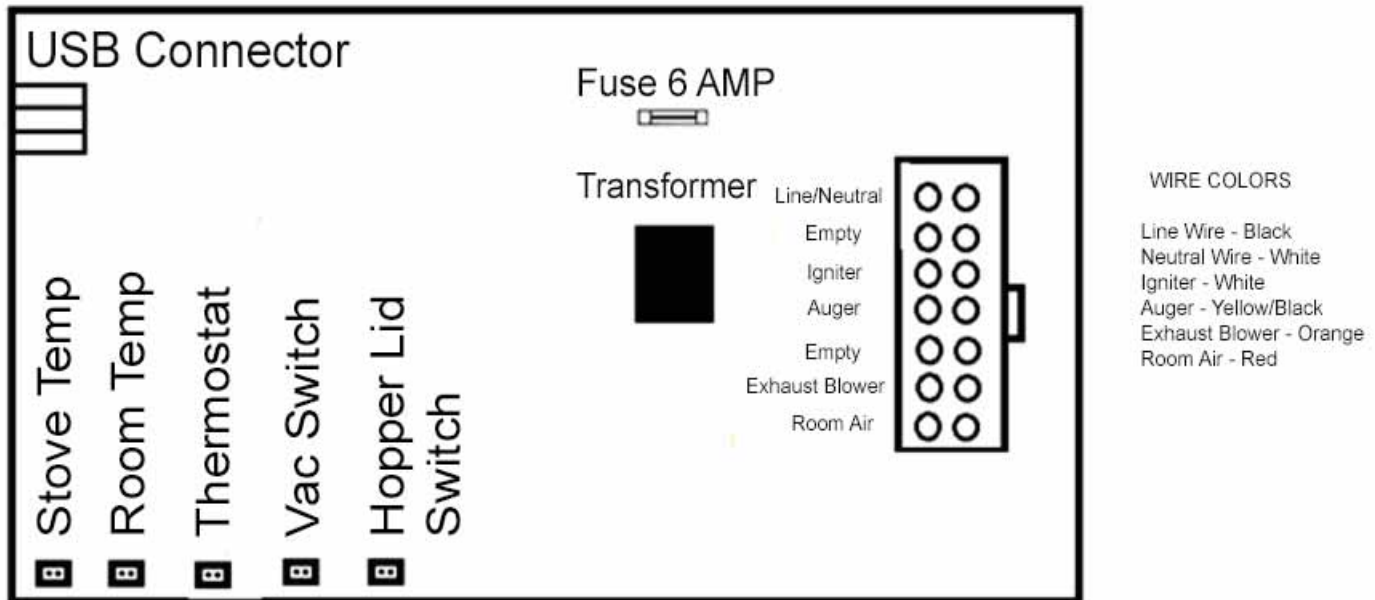

Caution – Shock Hazard

- Press the “Off” button and let the appliance completely cool BEFORE unplugging the appliance and beginning any maintenance or component replacement.
- Risk of shock if appliance is not unplugged before service.

Caution

Should you see any evidence of smoke in the hopper (smoke back), immediately close and latch the hopper lid and main door to the unit. Open the nearest windows and door to the outside, then press the OFF button and let the unit cool for at least 3 hours. Do not open the door or hopper lid. This is a maintenance problem that needs to be addressed.

Call Technical Support at (877) 356-6663

REPLACING COMPONENTS – SIDE MOUNTED CONTROL BOARD

The Control Board (Part # **PU-CB19**) is a digital read-out board. This board offers a wide variety of settings to operate the unit. This part can be removed from the unit by loosening the two outside screws and pulling the board back to the inside of the stove. The rear access panel should be removed prior to removing the control board. A 6-amp “quick-blow” fuse (Part # **PU-CBF6**) is used on this Control Board.

NOTE: The bottom three control buttons are preset at the factory and should *not* require any changes. See “Operating Instructions” and “Daily Operation” section of the manual for instructions on other Control Board settings.

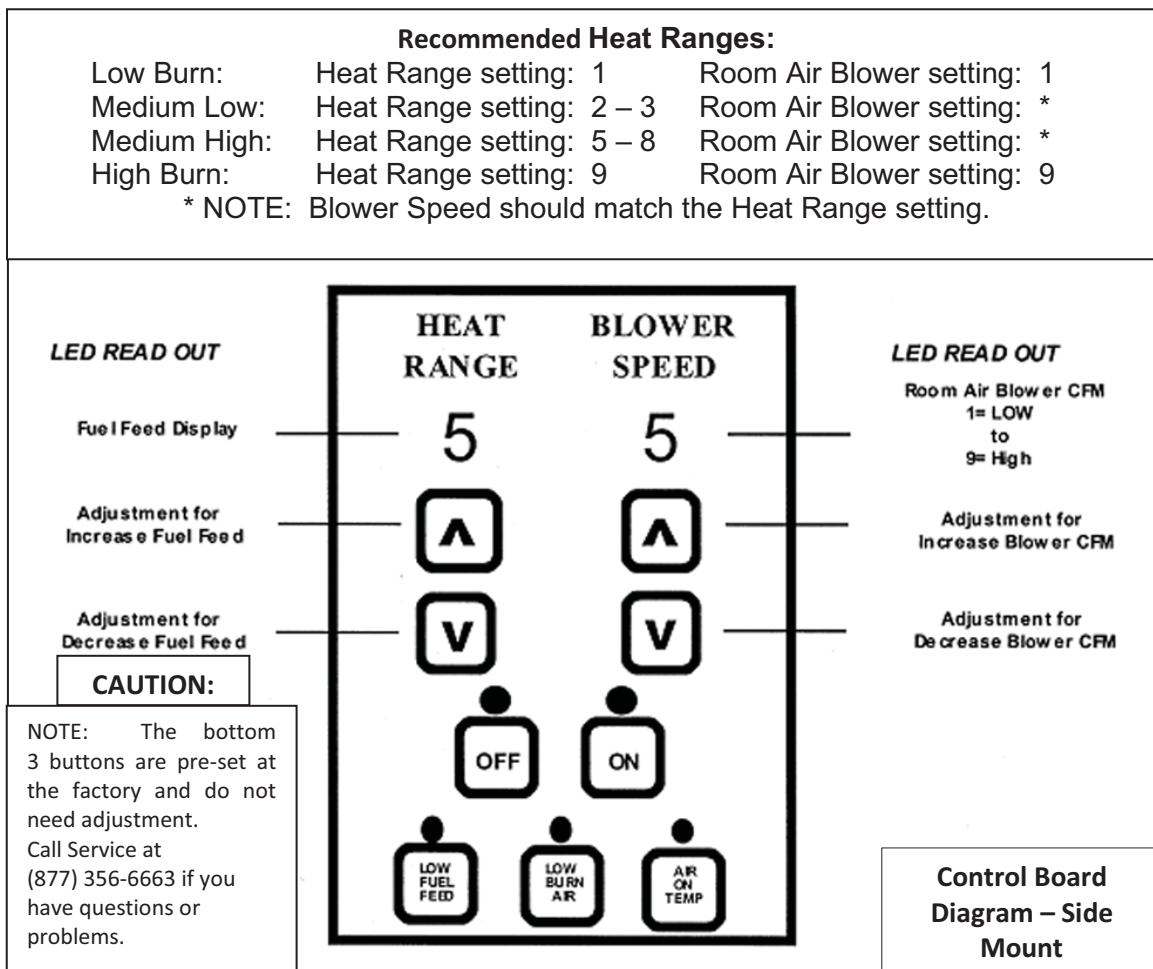

Caution

Should you see any evidence of smoke in the hopper (smoke back), immediately close and latch the hopper lid and door to the unit. Open the nearest windows and door to the outside, then press the OFF button and let the unit cool for at least 3 hours. Do not open the door or hopper lid. This is a maintenance problem that needs to be addressed.

Call Technical Support at (877) 356-6663

**Side Mounted
Control Board Wiring Diagram**

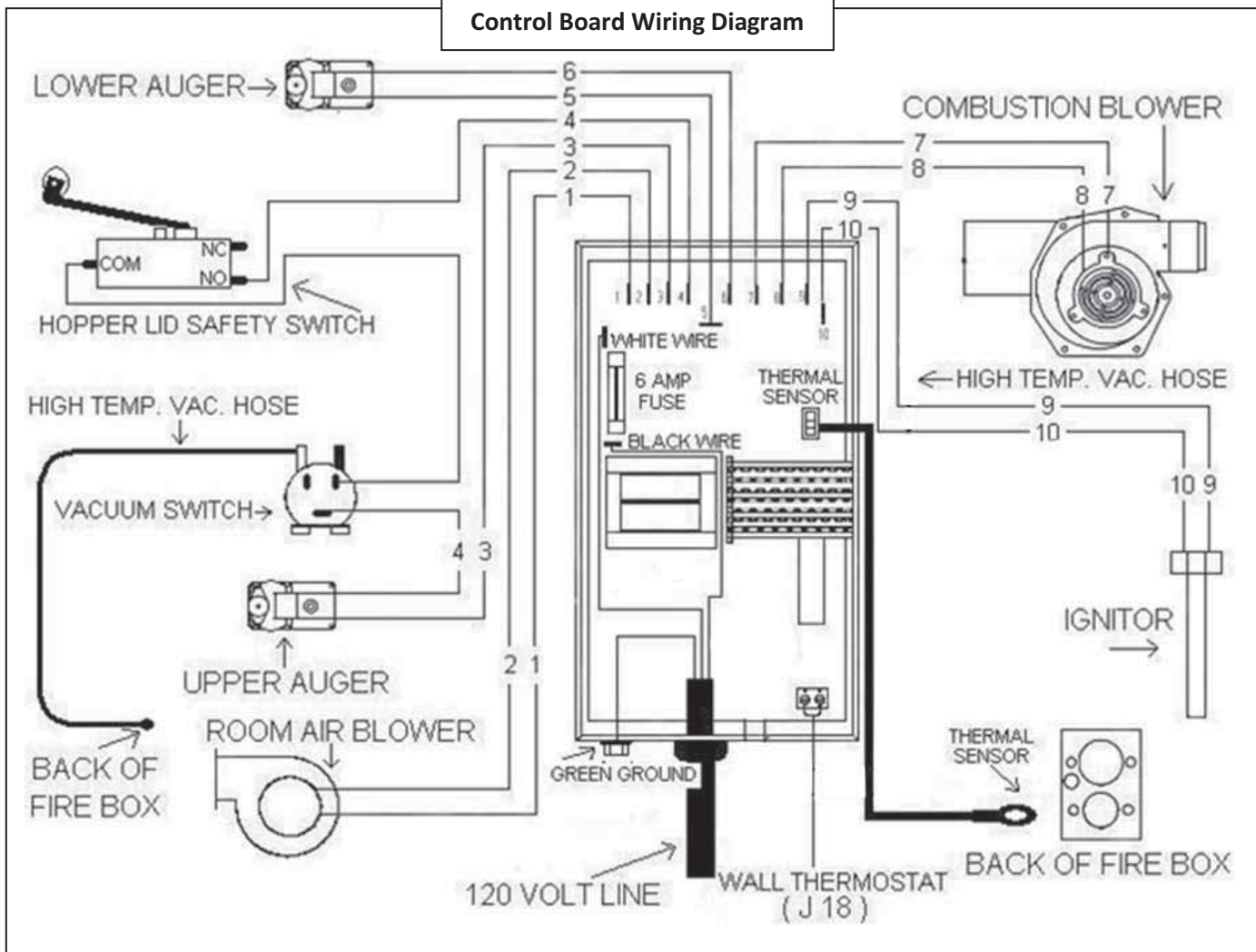

CAUTION: Moving Parts May Cause Injury.

Do NOT Operate with Panel(s) Off.

DANGER: Parts May Be Hot. Risk of Electric Shock.

Disconnect Power Before Servicing Unit.

IMPORTANT SAFETY NOTE: If the unit or chimney connector pipe “glows” red (or white), the stove is over-fired. This condition could cause a house or chimney fire. Do not operate your unit too hot, or over-firing may result.

Adjusting Hopper Lid Latch

The seals around the top of the pellet hopper are important to safe and efficient operation of the unit. The latch installed on this unit is designed to pull the hopper lid tight against this seal. Over the course of operation as these seals “wear in” and compress, the tension of the latch should be tested periodically, and adjusted if necessary.

To adjust the lid latch, the following tools will be needed; two ½ inch wrenches, or a ½ inch wrench and a ½ inch socket.

In order to adjust the latch, first (with the unit unplugged and cooled down) open the hopper lid and then lock the latch in its closed position. Take the ½ inch wrench and loosen the nut closest to the latch. This nut is then adjusted closer to the lid itself to tighten the latch. After adjusting this nut to the desired location, hold this nut in place with the ½ inch wrench, then tighten down the holding nut on the end of the latch shaft with the ½ inch socket (or second wrench) to hold the latching assembly in place.

After tightening the latch, test the latch for proper tension by locking the lid down and lifting each front corner of the lid. The lid should be firmly held down by the latch. Repeat the same procedure if the latch is still not tight enough.

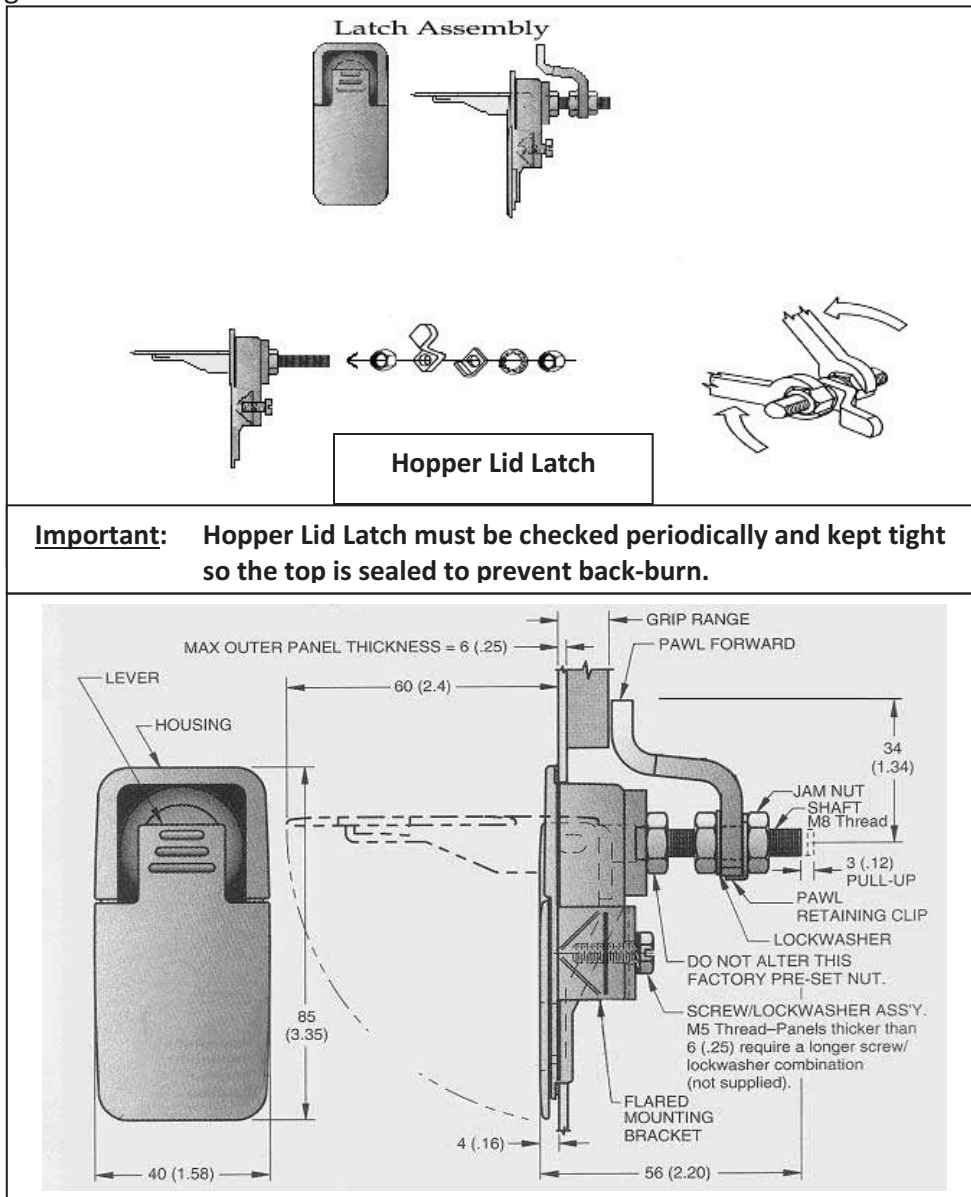

Pellet Stove – Exploded View Diagram

NUMBER	PART DESCRIPTION
1	Door (Part # CA-19A)
2	Door Gasket (Part # AC-DGKC)
3	Glass with Gasket (Part # AC-G9)
4	Impingement Plate*
5	Burn Pot
5a	Wear Plate for Burn Pot**
6	Burn Pot Gasket
7	Side Access Panel
8	Combustion Blower
9	3" Blower Adapter
10	Gasket for Combustion Blower Part # PU-CBG
11	Pellet Feeder Pot
12	Digital Control Board
13	Convection Blower
14	Augers: (Top Auger and Bottom Auger)
15	Block Bearing Gaskets
16	Block Bearings Part # PU-UCF204-12
17	3/4" I.D. Shaft Collars Part # PU-2X570
18	Auger Motors
19	Rear Access Panel
20	Hopper Flange Gasket Part # PU-HFG
21	Hopper
22	Hopper Lid Gasket Part # PU-HLG
23	Hopper Lid
24	Vacuum Shut Down Switch(es)
25	Hopper Lid Latches
26	Brass Louvers (Certain models only)
27	Cartridge Heater (Igniter) Assembly Part # PU-CHA

NOTE ON PART NUMBERS:

This diagram is a basic England's Stove Works pellet unit diagram. Your model may vary somewhat. See our online store at www.englishstoves.com or the parts list in your manual for specific part numbers for your model stove. If a part is not listed in the manual or on the website, or if you have questions, call (800) 245-6489.

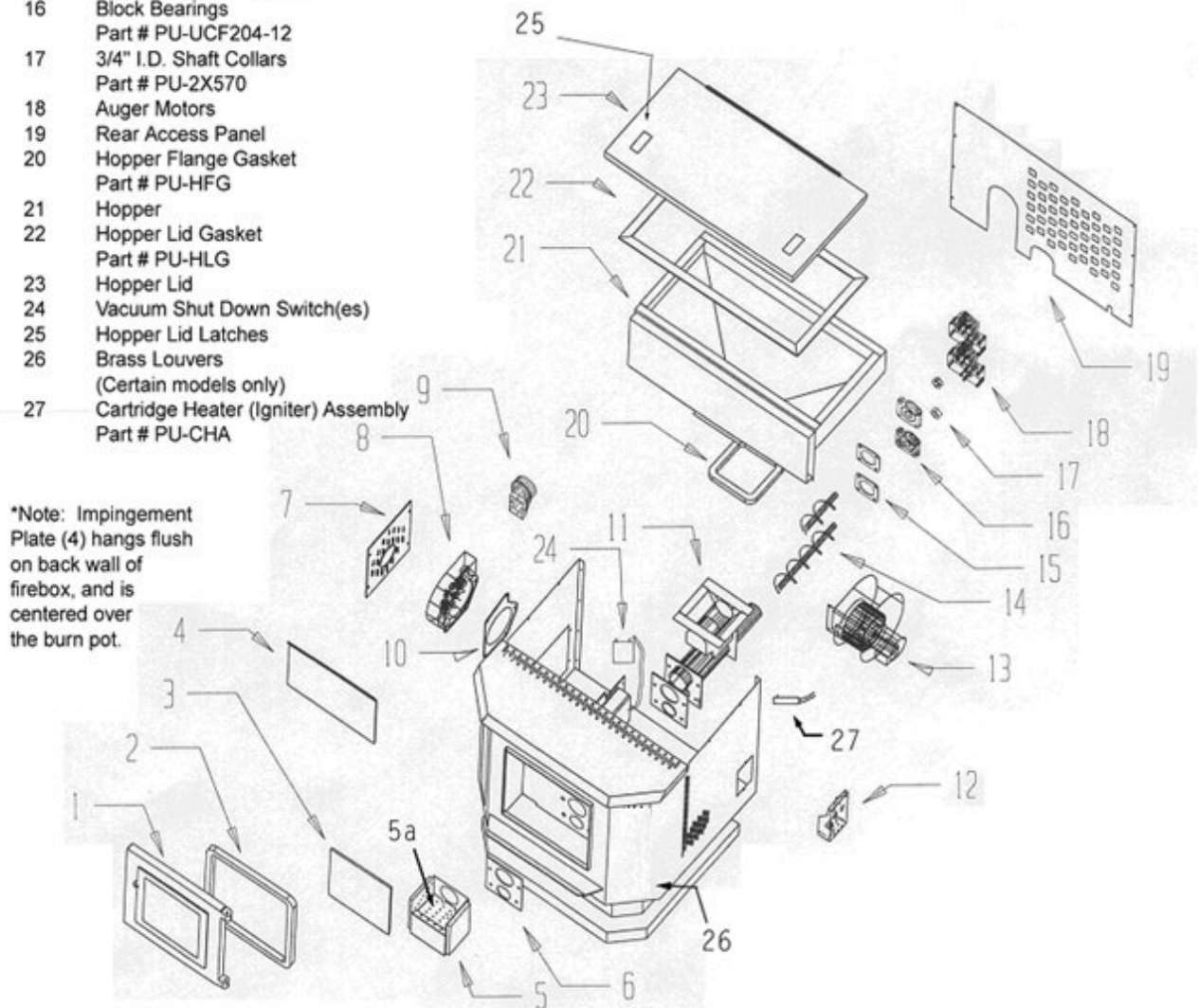

REPLACEMENT PARTS LIST

Part No	Description
AC-GGK	Glass Gasket Kit (gasket only, no glass)
AC-DGKC	Door Gasket Kit
AC-G9	9"x9" Glass with Gasket
AC-SHN	Nickel Door Spring Handle
AC-MBSP	Hi-Temperature Black Spray Paint
PU-047040	1 RPM Auger Motor Assembly
PU-BP18	Burn Pot Assembly
PU-BP18WP	Wear Plate (fits inside burn pot)
PU-076002B	Combustion (Exhaust) Blower – includes 3" adapter
PU-4C447	Convection (Room Air) Blower
PU-AF6T	Top Auger Shaft
PU-AF11B	Bottom Auger Shaft
PU-62-40-151-3	Hopper Lid Latch
PU-UCF204-12	Auger Bearing
PU-2X570	¾" Locking Collar
CU-VS	Vacuum Shut-Down Switch
PU-VH	Vacuum Hose
PU-CBMG	Combustion Blower & Motor Gasket
PU-BPG	Burn Pot Gasket
PU-ABGN	Auger Bearing Gasket
PU-HLG	Hopper Lid Gasket
PU-CHA	Cartridge Heater (Igniter) Assembly
PU-CBF6	6 AMP Control Board Fuse
AC-HLSB	Hopper Lid Safety Switch
AC-HP	Hinge Pin – rivet for cast door
PU-SSTCW	Thermocouple Wire <i>(only included on top mounted control board)</i>
IP-25PDVC	Top Baffle (inside firebox)
PU-SSCBHS	Heat Sensor for Control Board (for Top Mount models)
PU-CB14	Top Mounted Control Board (for Top Mount models)
AC-CMB	Control Board Mounting Box (included with top mounted control board)
PU-CB19	Side Mounted Control Board (for Side Mount models)

Parts may be ordered online at www.englander-stoves.com

If you have any questions, please contact the Technical Support Department:

Questions: (877) 356-6663

Website:

www.englander-stoves.com

You may write your unit's Manufacture Date and Serial Number in the blank spaces on this sample tag (next page), for future reference.

This sample tag also shows the safety info such as UL/ULC testing standard, etc. for your local officials, or anyone else who may need it for reference information.



MODEL 25-CAB80 55-SHPCAB80 55-TRPCAB80
 25-CAB80S 55-SHPCAB80S 55-TRPCAB80S

Pellet Fuel Room Heater; Free Standing Model Also for Use in Mobile Homes
 Certified to ASTM E 1309 / ULC S627 / ASTM E2779 / ASTM E2515 / CSA B415.1

U.S. Test Standards: US EPA 40 CFR Part 60, Subpart 60.536

Manufactured by:
 Stove Builder International Inc.
 589 S. Five Forks Rd.
 Monroe, VA 24574

Manufacture Date	20130308
Serial Number	999998
Work Order	(# test)

PREVENT HOUSE FIRES

- Install and use only in accordance with the Owner's manual provided with this appliance.
- Contact local building or fire officials about restrictions and installation inspections in your area.
- For use with wood pellet fuel only, 1/4 inch in diameter.
- Do not connect this unit to a chimney flue serving another appliance
- Keep viewing and ash removal doors tightly closed during operation.
- Maximum input rating: 3.8 lbs/hr
- 1.13 Grams/hr
- U.S. ENVIRONMENTAL PROTECTION AGENCY Certified to comply with 2020 particulate emission standards.
- Use only approved type L or P pellet vent pipe.
- Room heater, pellet fuel-burning type, also for use in mobile homes.
- Inspect and clean chimney frequently. Under certain conditions of use, creosote buildup may occur rapidly.
- Replace with ceramic glass only.
- A source of fresh air must be provided to the room. When installed in a mobile home, air from outdoors must be provided.
- Do not obstruct combustion air opening.

FREESTANDING INSTALLATION REQUIREMENTS - Refer to local codes and the chimney manufacturer's instructions for precautions required for passing a chimney through a combustible wall or ceiling. The unit must be installed on a non-combustible floor protection, which extends 6-inches to the front and 6-inches on each side of the door opening. See owner's manual for additional clearance information.

Clearances to combustibles

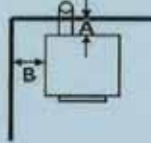

A: 0 in. 0 mm
 B: 7 in. 178 mm

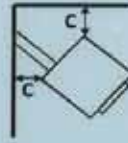

C: 5 in. 127 mm



Floor protection
 Protection de plancher
 E: 6 in. 152 mm
 F: 6 in. 152 mm

Electrical rating: 115 V, 60 Hz, 4 A. ROUTE THE POWER CORD SO THAT IT DOES NOT COME INTO CONTACT WITH ANY HOT SURFACES ON THE UNIT AND DOES NOT CROSS IN FRONT OF THE UNIT.

Refer to Intertek's directory of building products (<https://bpdirectory.intertek.com>) for detailed information.

CAUTION - Moving parts may cause injury. Do not operate with panels removed.
CAUTION - Hot parts. Do not operate unit with panels removed.
DANGER - Risk of electric shock. disconnect power before servicing unit.

CAUTION - Operate this unit only with the fuel hopper lid closed. Failure to do so may result in emission of products of combustion from the hopper under certain conditions. Maintain hopper seal in good condition. Do not overfill the hopper.

This wood heater needs periodic inspection and repair for proper operation. Consult the owner's manual for further information. It is against US federal regulations to operate this wood heater in a manner inconsistent with the operating instructions in the owner's manual.



CAUTION

- **HOT WHILE IN OPERATION. DO NOT TOUCH. KEEP CHILDREN, CLOTHING AND FURNITURE AWAY. CONTACT MAY CAUSE SKIN BURNS. SEE NAME-PLATE AND INSTRUCTIONS. OPERATE THIS UNIT ONLY WITH THE FUEL HOPPER LID CLOSED. FAILURE TO DO SO MAY RESULT IN EMISSION OF PRODUCTS OF COMBUSTION FROM THE HOPPER UNDER CERTAIN CONDITIONS. DO NOT OVERFILL THE HOPPER. MOVING PARTS MAY CAUSE INJURY. HOT PARTS. DO NOT OPERATE UNIT WITH THE SIDE OR REAR PANELS REMOVED. MAINTAIN HOPPER SEAL IN GOOD CONDITION.**



WARNING: This product can expose you to carbon monoxide, which is known to the State of California to cause cancer, birth defects or other reproductive harm. (For more information go to www.p65warnings.ca.gov)



Fabricant de poêles international
 Stove Builder International

27907

IMPORTANT! READ AND FOLLOW ALL INSTALLATION AND MAINTENANCE INSTRUCTIONS, INCLUDING CLEANING THE UNIT AS SPECIFIED, AND REPLACING GASKETS ANNUALLY, AND PARTS AS NEEDED. ENGLANDER IS NOT RESPONSIBLE FOR ANY DAMAGE OR INJURY INCURRED DUE TO NEGLIGENCE, OR DUE TO UNSAFE INSTALLATION OR USAGE OF THIS PRODUCT. CALL TECHNICAL SUPPORT WITH ANY QUESTIONS.

LIMITED FIVE (5) YEAR WARRANTY

From the date of purchase to the original owner.

Model Numbers 25-CAB80 / 55-SHPCAB80 / 55-TRPCAB80

The manufacturer extends the following warranties:

Five Year Period:

1. Carbon steel and welded seams in the firebox are covered for five (5) years against splitting.
2. The steel door and hinges are covered for five (5) years against cracking.

One Year Period:

1. Component parts such as the hopper, auger, burn-pot, auger shaft and fasteners are covered for one (1) year against cracking, breakage and welded seam separation.
2. Electrical components, accessory items, glass and the painted surface of the stove are covered for one (1) year from the date of purchase.

Conditions and Exclusions

1. Damage resulting from over-firing will void your warranty.
2. This warranty does not apply if damage occurs because of an accident, improper handling, improper installation, improper operation, abuse or unauthorized repair made or attempted to be made.
3. The manufacturer is not liable for indirect, incidental, or consequential damages in connection with the product including any cost or expense, providing substitute equipment or service during periods of malfunction or non-use.*
4. All liability for any consequential damage for breach of any written or implied warranty is disclaimed and excluded.
5. This unit is EPA certified using high quality, Premium Grade pellet fuel. Warranty is void if the unit is used to burn materials for which the unit is not certified by the EPA.

Warranty is void if unit is not used according to the owner's manual.

*Some states do not allow the exclusion of limitations of incidental or consequential damages, so the above may not apply to you

Procedure

Purchaser must give notice of claim of defect within the warranty period and pay transportation to and from a service center designated by the manufacturer. The dealer from which the unit was purchased or the factory, at our option, will perform the warranty service.

Other Rights

This warranty gives you specific legal rights; you may also have other rights, which may vary from state to state.

To submit a Warranty Claim, call (877) 356-6663 to speak with our Technical Support department. You may also file a Warranty Claim at www.englander-stoves.com

For parts, warranty replacement procedures may be found at our parts store site located at Englander-stoves.com

Important Notice

This registration information **MUST** be on file for this warranty to be valid. Please send this information within thirty (30) days from the original date of purchase.

Use any of these three easy ways to send your warranty information in!

Mailing Address

Stove Builder International inc.

250, rue de Copenhague,
St-Augustin-de-Desmaures
(Québec) Canada
G3A 2H3

Fax Number

(418) 878-3001 – Twenty-four hours a day

Online Registration

To register online, visit our warranty registration website at:

<https://www.englander-stoves.com/ca/en/warranty-registration/>

Please Note: This warranty is null and void if the attached warranty registration AND a copy of the sales receipt is not returned within thirty (30) days from the date of purchase.

Warranty is not transferable.

WARRANTY REGISTRATION for Englander

Purchaser Information*

I. Purchased By (Name) _____

II. Address _____

III. City _____ State _____ Zip Code _____

IV. Telephone Number _____

V. Email Address _____

Dealer Information*

VI. Purchased From _____

VII. Address _____

VIII. City _____ State _____ Zip Code _____

Unit Information*

IX. Model Number _____ Purchase Date _____

X. Purchase Price _____

XI. Serial Number _____ Mfg. Date _____

Purchase Questions

How did you first hear about our product? (Please check one)

Word of Mouth _____ Burn Trailer Demonstration _____ Internet _____

Other: _____

Where did you receive information about our product?

Via Telephone _____ Dealer (Name of dealer) _____ Internet _____

Other: _____

*** Required Information**