

Specifications

Applications

DuraChimney II is a double-wall, air-cooled chimney system for use with masonry fireplaces which burn wood, oil, coal, or gas.

Materials and Construction

.016" 430 stainless steel inner wall and .021" galvanized steel outer wall. For stainless steel outer wall, contact Customer Service for a quote.

Unitized pipe sections. No field assembly of inners and outers required.

Clearances

2" clearance to combustibles.

Shrouds

UL Listed with DuraVent shroud specifications. Information available online at www.duravent.com

Diameters

8", 10", 12", 14", and 16".

Listings

UL Listed to UL 103 and ULC S604 standards (MH7399).



UL 103 and ULC S604 System

DuraChimney II

DuraChimney II is an exceptional factory-built alternative to pre-fabricated masonry chimneys. DuraChimney II is a unitized, lightweight design which eliminates the need for field assembly of pipe sections, allowing for faster installation.

DuraChimney II is designed to stay cool on the outside, to provide a hot draft on the inside and to provide a fire-safe design that protects both the chimney and the building.

The double-wall, air-cooled design allows the chimney to expand both radially and lengthwise under high temperatures.

DuraChimney II is tested and listed for continuous operation at 1000°F flue gas temperatures, one hour at 1400°F and ten-minutes at 1700°F, in accordance with the UL 103 test standard.



Typical Installations

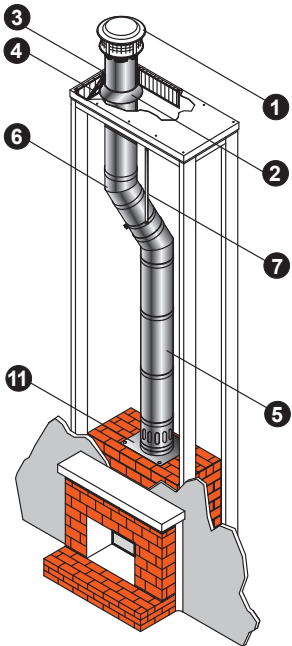

Masonry Firebox with Metal Chimney

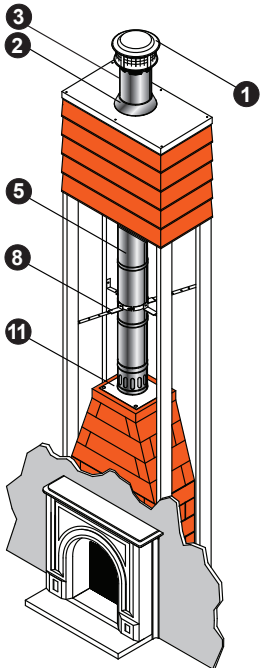

Prefabricated Masonry Fireplace Kit with Metal Chimney

Installation Key			
1	Chimney Cap	8	Stabilizer
2	Storm Collar	9	Firestop
3	Chase Top Flashing	10	Attic Insulation Shield
4	Roof Radiation Shield	11	Anchor Plate/ Anchor Plate with Damper
5	Chimney Section	12	Supplementary Support
6	Elbow	13	Wall Strap
7	Elbow Strap		

Refer to our Typical Installation drawings to select the appropriate component parts for your installation.

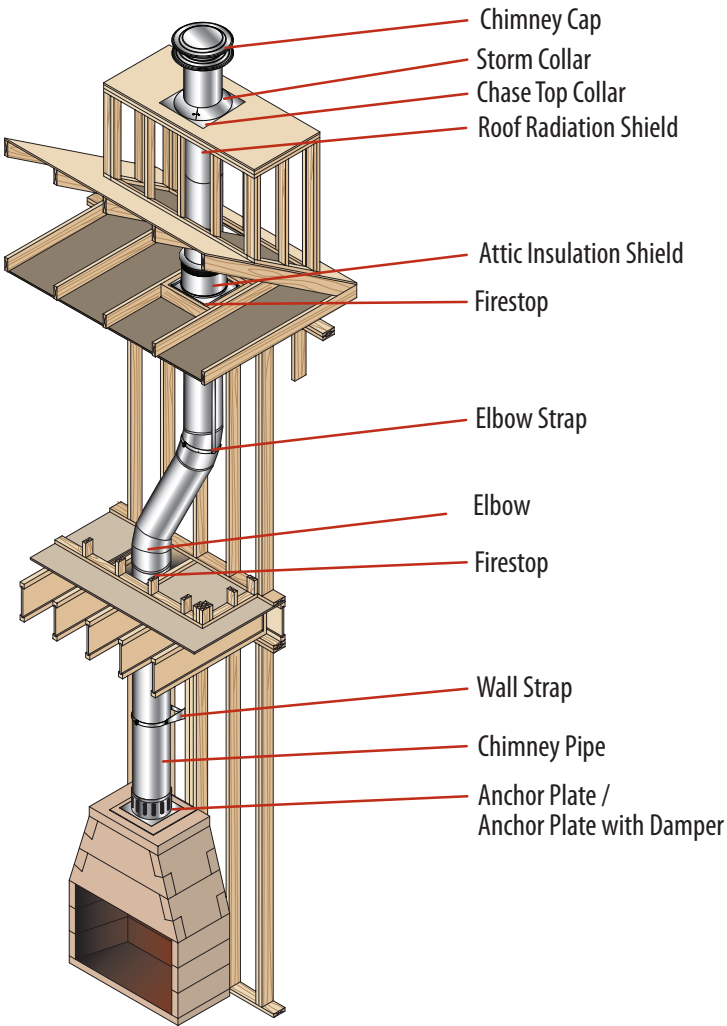

Planning Your Installation

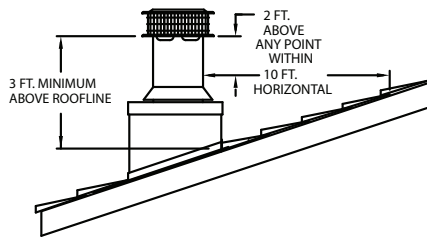
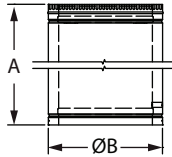

Figure 1

The following recommendations are a general guideline to assist in the layout and selection of the chimney components needed for your installation. Always follow DuraVent Installation instructions enclosed with the cap or support box before installing your chimney system. Installation instructions can be viewed online at www.duravent.com, under catalogs > instructions.

- Measure the diameter of the fireplace flue outlet. An improperly sized chimney results in poor draft and excessive creosote formation.
- Select the chimney with the same size diameter as the fireplace flue outlet. Refer to the chimney sizing chart in the back of this catalog section for masonry fireplaces.
- Install the chimney in an enclosed chase.
- If possible, avoid offsets. A straight vertical installation is more efficient and less likely to develop creosote. If an offset is required to avoid rafters or other obstructions, measure the horizontal distance required and the vertical height available. Both 15° and 30° elbows are available. Elbows greater than 30° are not allowed in the United States. Two offsets (four elbows) in a single installation are permitted. Refer to the offset chart in the back of this catalog section. At least one Elbow Strap is required. Elbow Straps ensure adequate support.
- Determine the minimum chimney height above the roof line. Building codes require a minimum of 3' above the roof penetration and at least 2' higher than any portion of a building within 10'. See figure 1. The termination cap is installed above that point.
- A Chase Top Flashing is available. A pitched roof flashing can be locally made, if required. A storm collar is required for all installations using a flashing.
- Determine the total length of chimney required for the installation. To calculate the installed per length of 10"-16" DuraChimney II pipe, subtract 1" per joint. Minimum recommended chimney height, at sea level, of straight vertical chimney, is 10' to 15' above the fireplace outlet. Higher elevations, or the use of elbows, will require approximately 30% to 60% more height to provide for an adequate draft.
- For a UL approved shroud, see the DuraChimney II Shrouds Installation Instructions (L181). View online at www.duravent.com, under catalogs > instructions.
- Be fire safe. Maintain at least 2" clearance to combustibles. Follow local building codes and have your chimney inspected by a certified professional.

Chimney Pipe



DuraChimney II pipe is available in 12", 18", 36", and 48" lengths. To calculate the installed length of DuraChimney II pipe, subtract 1" from each length of chimney pipe.

For stainless steel outer wall, call Customer Service for quote and part number. DuraChimney II is built to order and is not returnable.

SIZE	ORDER #	STOCK #	A	B
8"	8DCA-12	810013678	12"	12"
8"	8DCA-18	810013677	18"	12"
8"	8DCA-24	810013676	24"	12"
8"	8DCA-36	810013675	26"	12"
8"	8DCA-48	810013674	48"	12"
10"	10DCA-12	810000781	12"	13"
10"	10DCA-18	810000782	18"	13"
10"	10DCA-36	810000783	36"	13"
10"	10DCA-48	810000784	48"	13"
12"	12DCA-12	810000803	12"	15"
12"	12DCA-18	810000804	18"	15"
12"	12DCA-36	810000805	36"	15"
12"	12DCA-48	810000806	48"	15"
14"	14DCA-12	810000824	12"	17"
14"	14DCA-18	810000825	18"	17"
14"	14DCA-36	810000826	36"	17"
14"	14DCA-48	810000827	48"	17"
16"	16DCA-12	810000845	12"	19"
16"	16DCA-18	810000846	18"	19"
16"	16DCA-36	810000847	36"	19"
16"	16DCA-48	810000848	48"	19"

15° Elbow

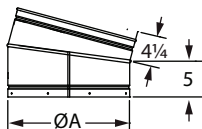

Use elbows to offset obstructions such as rafters, ridgepoles, or joists. 10"-16" DuraChimney II may have two pair of elbows, if needed. Offsets greater than 30° are not allowed. Elbows are not adjustable.

SIZE	10"	12"	14"	16"
A	13"	15"	17"	19"
ORDER #	10DCA-E15	12DCA-E15	14DCA-E15	16DCA-E15
STOCK #	810000785	810000807	810000828	810000849

30° Elbow



Use elbows to offset obstructions such as rafters, ridgepoles, or joists. 10"-16" DuraChimney II may have two pair of elbows, if needed. Offsets greater than 30° are not allowed. Elbows are not adjustable.

SIZE	10"	12"	14"	16"
A	13"	15"	17"	19"
ORDER #	10DCA-E30	12DCA-E30	14DCA-E30	16DCA-E30
STOCK #	810000786	810000808	810000829	810000850

15° Elbow Kit



The 8" DuraChimney II Elbow Kits include 2 elbows and 1 elbow strap. Use to offset around obstructions such as rafters, ridge poles, or joists. Offsets greater than 30° is not allowed. Elbows are not adjustable.

15°	8"
A	12"
ORDER #	8DCA-E15K
STOCK #	810013697

30° Elbow Kit



The 8" DuraChimney II Elbow Kits include 2 elbows and 1 elbow strap. Use to offset around obstructions such as rafters, ridge poles, or joists. Offsets greater than 30° is not allowed. Elbows are not adjustable.

30°	8"
A	12"
ORDER #	8DCA-E30K
STOCK #	810013679

Elbow Strap

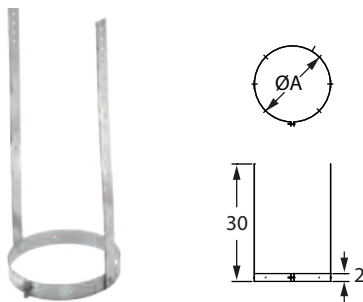

Use between two elbows to support the weight of the chimney.

SIZE	8"	10"	12"	14"	16"
A	12 3/8"	13 3/8"	15 3/8"	17 3/8"	19 3/8"
ORDER #	8DCA-ES	10DCA-ES	12DCA-ES	14DCA-ES	16DCA-ES
STOCK #	810013698	810000787	810000809	810000830	810000851

Supplementary Support

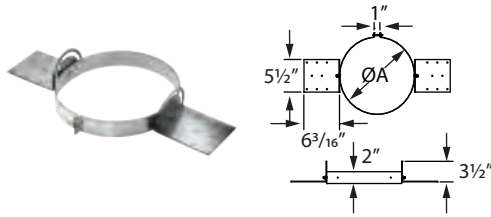

Use to help support the weight of DuraChimney II. Supports a maximum of 25' of chimney. Use additional Supplementary Supports as needed.

SIZE	8"	10"	12"	14"	16"
A	12 3/8"	13 3/8"	15 3/8"	17 3/8"	19 3/8"
ORDER #	8DCA-SS	10DCA-SS	12DCA-SS	14DCA-SS	16DCA-SS
STOCK #	810013699	810000788	810000810	810000831	810000852

Wall Strap

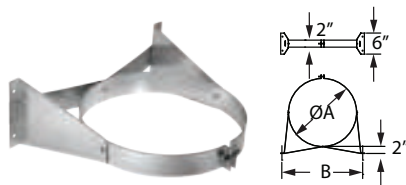

Use to support and to stabilize the chimney in interior or exterior installations to ensure a 2" clearance. Wall Straps are required every 8' on exterior of the building only.

SIZE	8"	10"	12"	14"	16"
A	12 3/8"	13 3/8"	15 3/8"	17 3/8"	19 3/8"
B	15 3/4"	15 15/16"	18 1/8"	20 3/8"	22 1/16"
ORDER #	8DCA-WS	10DCA-WS	12DCA-WS	14DCA-WS	16DCA-WS
STOCK #	810013700	810000800	810000821	810000842	810000863

Stabilizer

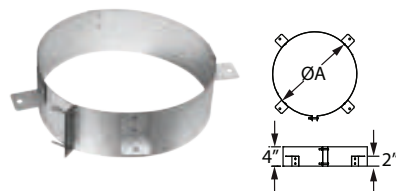

Use to hold DuraChimney II in place. Use inside chase enclosures to stabilize the chimney. Refer to the fireplace manufacturer for additional requirements on the use of Stabilizer.

SIZE	8"	10"	12"	14"	16"
A	12 3/8"	13 3/8"	15 3/8"	17 3/8"	19 3/8"
ORDER #	8DCA-ST	10DCA-ST	12DCA-ST	14DCA-ST	16DCA-ST
STOCK #	810013701	810000789	810000813	810000832	810000853

Anchor Plate

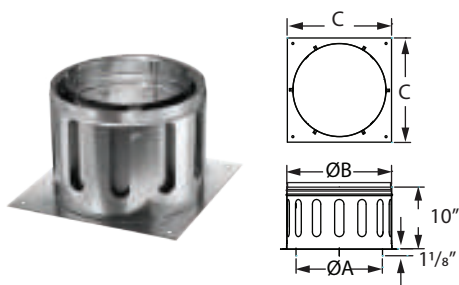

Use as a starter section for DuraChimney II. Bolts directly to the fireplace outlet.

SIZE	8"	10"	12"	14"	16"
A	8"	10"	12"	14"	16"
B	12"	13"	15"	17"	19"
C	14"	15"	17"	19"	21"
ORDER #	8DCA-AP	10DCA-AP	12DCA-AP	14DCA-AP	16DCA-AP
STOCK #	810013686	810000790	810000811	810000833	810000854

Anchor Plate w/ Damper

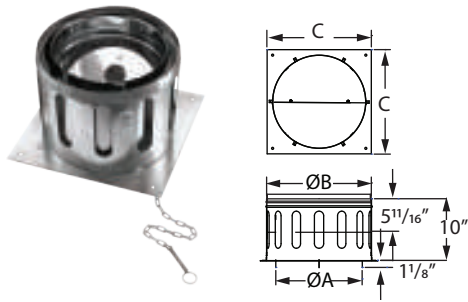

Use as a starter section for DuraChimney II. Bolts directly to the fireplace outlet. Damper section allows the chimney to be closed when the fireplace is not in use. Includes chain and lintel hook.

SIZE	10"	12"	14"	16"
A	10"	12"	14"	16"
B	13"	15"	17"	19"
C	15"	17"	19"	21"
ORDER #	10DCA-APD	12DCA-APD	14DCA-APD	16DCA-APD
STOCK #	810000791	810000812	810000834	810000855

Firestop

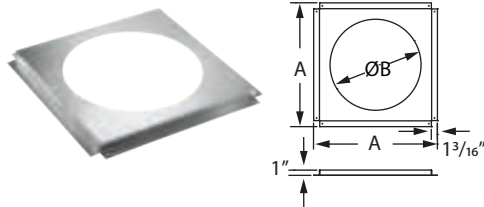

Use in ceiling/floor penetrations above fireplace. A Firestop is not required when passing through the roof. Fits on the underside of ceiling.

SIZE	8"	10"	12"	14"	16"
A	17 7/8"	19 5/8"	21 5/8"	23 5/8"	25 5/8"
B	12 3/8"	13 3/8"	15 3/8"	17 3/8"	19 3/8"
ORDER #	8DCA-FS	10DCA-FS	12DCA-FS	14DCA-FS	16DCA-FS
STOCK #	810013680	810000792	810000814	810000835	810000856

30° Firestop

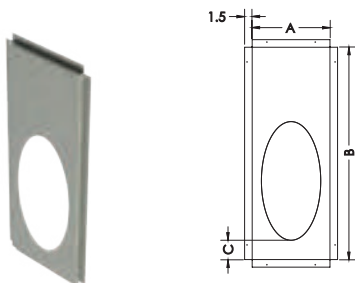

Designed for use when the chimney passes through a wall at a 30° angle from the vertical.

SIZE	8"
A	16"
B	43 1/2"
C	4"
ORDER #	8DCA-FS30
STOCK #	810013681

Attic Insulation Shield

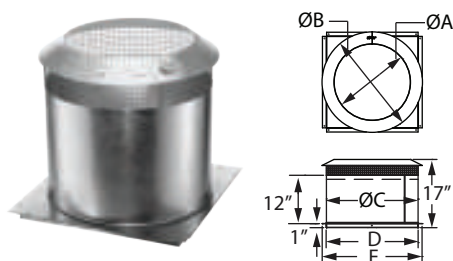

Use in all installations that pass through an attic to prevent insulation and debris from accumulating near the chimney, unless the chimney is enclosed through attic. Consists of two parts – a collar and a base.

SIZE	8"	10"	12"	14"	16"
A	12"	13"	15"	17"	19"
B	16"	17"	19"	21"	29"
C	15 13/16"	16 13/16"	18 13/16"	20 13/16"	22 13/16"
D	15 7/8"	16 7/8"	18 7/8"	20 7/8"	22 7/8"
E	17 13/16"	18 13/16"	20 13/16"	22 13/16"	24 13/16"
ORDER #	8DCA-IS	10DCA-IS	12DCA-IS	14DCA-IS	16DCA-IS
STOCK #	810013703	810000793	810000815	810000836	810000857

Roof Radiation Shield

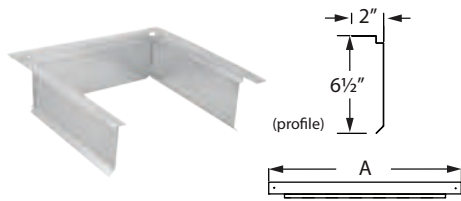

Required at the top of chase enclosure or where the chimney passes through the roof. A Roof Radiation Shield is not required if the chimney is unenclosed in the attic. Four plates (included) make up one shield. Three of the four plates shown.

SIZE	8"	10"	12"	14"	16"
A	19"	20"	22"	24"	26"
ORDER #	8DCA-RRS	10DCA-RRS	12DCA-RRS	14DCA-RRS	16DCA-RRS
STOCK #	810013704	810000794	810000816	810000837	810000858

Chase Top Flashing

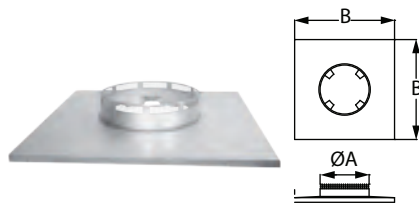

Encloses the top of a chase while providing a ventilation air passage to the chase. Includes spacer clips.

SIZE	8"	10"	12"	14"	16"
A	15"	16"	18"	20"	22"
B	34"	20"	36"	38"	40"
ORDER #	8DCA-CTF	10DCA-CTF	12DCA-CTF	14DCA-CTF	16DCA-CTF
STOCK #	810013705	810000795	810000817	810000838	810000859

Chase Top Collar

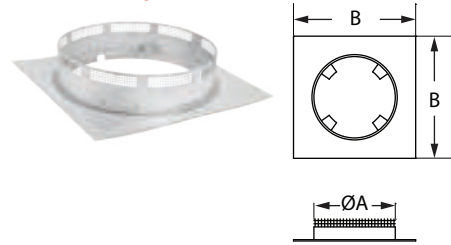

Use to construct custom sized chase tops. Provides necessary ventilation and spacing to maintain UL listing for chimney system.

SIZE	8"	10"	12"	14"	16"
A	15"	16"	18"	20"	22"
B	20"	20"	22"	24"	26"
ORDER #	8DCA-CTC	10DCA-CTC	12DCA-CTC	14DCA-CTC	16DCA-CTC
STOCK #	810013706	810000796	810000818	810000839	810000860

Storm Collar

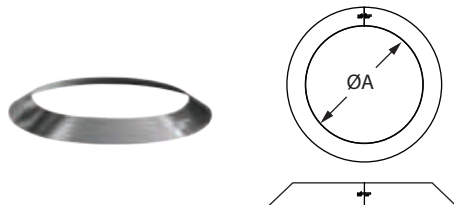

Use to help prevent rain from entering the chase. Use with a flashing and a Chimney Cap.

SIZE	8"	10"	12"	14"	16"
A	12"	13"	15"	17"	19"
ORDER #	8DCA-SC	10DCA-SC	12DCA-SC	14DCA-SC	16DCA-SC
STOCK #	810013682	810000798	810000820	810000841	810000862

Chimney Cap

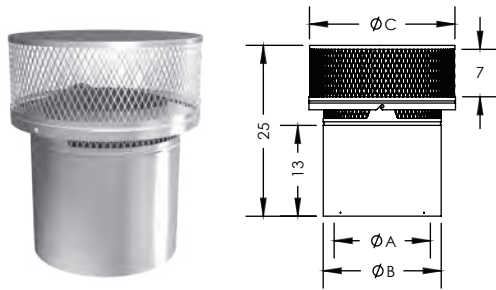

Use to terminate the chimney system. Required on all installations. Slides over the previous section of DuraChimney II pipe to allow for chimney height adjustment. Includes a Spark Arrestor.

For stainless steel outer wall, call Customer Service. DuraChimney II is built to order and is not returnable.

SIZE	10"	12"	14"	16"
A	10"	12"	14"	16"
B	13"	15"	17"	19"
C	18"	21"	21"	23"
ORDER #	10DCA-VC1	12DCA-VC1	14DCA-VC1	16DCA-VC1
STOCK #	810014049	810014050	810014051	810014052

8" Chimney Cap

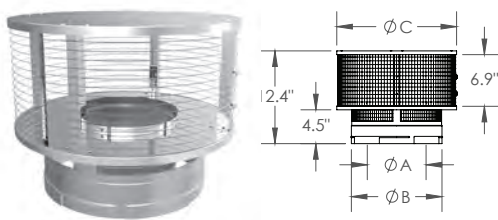

Use to terminate the chimney system. Required on all installations. Slides over the previous section of DuraChimney II pipe to allow for chimney height adjustment. Includes a Spark Arrestor.

For stainless steel outer wall, call Customer Service. DuraChimney II is built to order and is not returnable.

SIZE	8"
A	7 9/16"
B	12"
C	16"
ORDER #	8DCA-VC
STOCK #	810013683

Roof Flashing

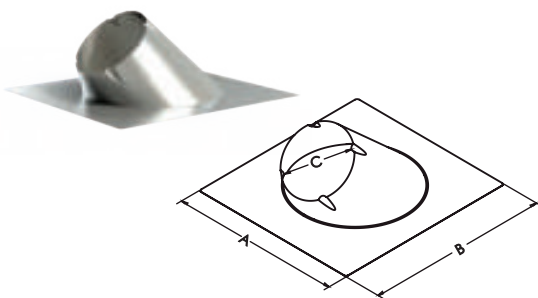

Use to weather proof the penetration of the chimney pipe through the roof. Storm collar required. Select a roof flashing based on the pitch of the roof. For example, a 6/12 pitch has a vertical rise of 6" over a horizontal distance of 12".

SIZE	8"	SIZE	8"		
0/12 - 6/12 PITCH	A	26"	7/12 - 12/12 PITCH	A	33 1/2"
	B	26"		B	36"
	C	12"		C	12"
	ORDER #	8DCA-F6		ORDER #	8DCA-F12
STOCK #	810013684	STOCK #	810013685		

European Copper Adapter - King Model

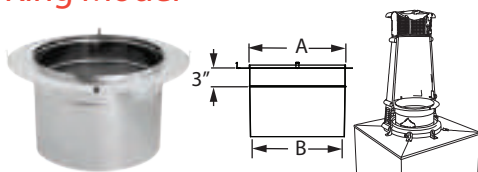

Use for installing the European Copper Chimney Pots King model shroud/pot onto DuraChimney II chimney.

SIZE	10"	12"	14"
A	10"	12"	14"
B	9 1/2"	11 1/2"	13 1/2"
ORDER #	10DCA-ECK	12DCA-ECK	14DCA-ECK
STOCK #	810000801	810000822	810000843

European Copper Adapter - Bishop Model

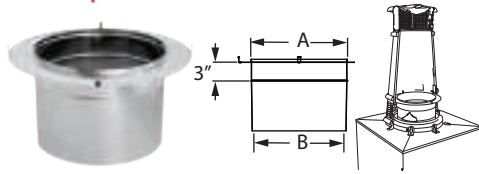

Use for installing the European Copper Chimney Pots Bishop model shroud/pot onto DuraChimney II chimney. King model shown.

SIZE	10"	12"	14"	16"
A	10"	12"	14"	16"
B	9 1/2"	11 1/2"	13 1/2"	15 1/2"
ORDER #	10DCA-ECB	12DCA-ECB	14DCA-ECB	16DCA-ECB
STOCK #	810000802	810000823	810000844	810000864

Snow Splitter

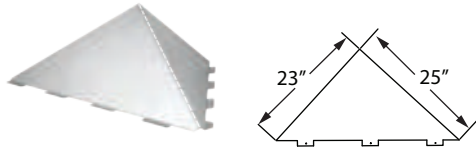

Use to divert snow around chimney, vent, and roof flashing. Constructed of paintable galvanized material. Ships flat for easy assembly.

SIZE	6"
ORDER #	6DT-SP
STOCK #	810000139

Elbow Offset Chart

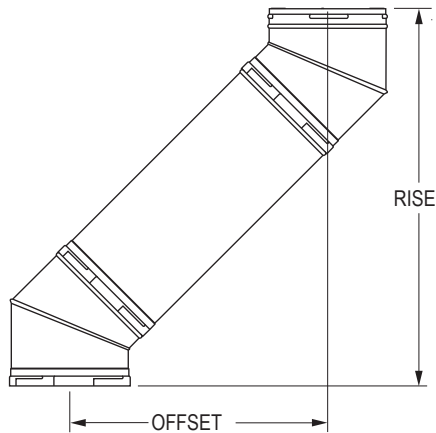

Elbow Angle From Vertical	Chimney Length Between Elbows	Size 10" I.D.		Size 12" I.D.		Size 14" I.D.		Size 16" I.D.	
		Offset Inches	Rise Inches	Offset Inches	Rise Inches	Offset Inches	Rise Inches	Offset Inches	Rise Inches
15°	0"	2 9/16"	20 3/8"	2 3/8"	21 5/8"	2 5/8"	21 5/8"	2 3/4"	21 1/8"
15°	12"	5 3/8"	31 1/4"	5 1/2"	31 3/4"	5 1/2"	32 1/4"	5 5/8"	32 3/4"
15°	18"	7"	37"	7"	37 1/2"	7 1/8"	38"	7 1/8"	36 1/2"
15°	36"	11 5/8"	54 1/2"	11 5/8"	55"	11 3/4"	55 3/8"	11 3/4"	55 7/8"
15°	48"	14 3/4"	66"	14 3/4"	66 1/2"	14 7/8"	67"	14 7/8"	67 1/2"
30°	0"	5 3/4"	22 3/8"	6"	22 3/8"	6 1/4"	24 1/2"	6 5/8"	25 1/2"
30°	12"	11 1/4"	32"	11 1/2"	33"	11 3/4"	34"	12"	35 1/2"
30°	18"	14 1/4"	37 1/8"	14 1/2"	38 1/8"	14 3/4"	39 1/4"	15"	40 5/8"
30°	36"	23 1/4"	52 3/4"	23 1/2"	53 3/4"	23 3/4"	54 7/8"	24"	56 1/4"
30°	48"	29 1/4"	63 1/8"	29 1/2"	64 1/8"	29 3/4"	65 1/4"	30"	66 5/8"

Chimney Sizing Chart for Fireplace Installations

