

**MODEL CR8T**  
**VENT-FREE OR VENTED GAS LOGS**  
FOR NATURAL OR LIQUID PETROLEUM (L.P.)



**WARNING: If the information in this manual is not followed exactly, a fire or explosion may result causing property damage, personal injury, or loss of life .**

-DO NOT STORE OR USE GASOLINE OR OTHER FLAMMABLE VAPORS AND LIQUIDS IN THE VICINITY OF THIS OR ANY OTHER APPLIANCE.

-WHAT TO DO IF YOU SMELL GAS

\*Do not try to light any appliance.

\*Do not touch any electrical switch; do not use any phone in your building.

\*Immediately call your gas supplier from a neighbor's phone.

Follow the gas supplier's instructions.

\*If you cannot reach the gas supplier, call the fire department.

-Installation and service must be performed by a qualified installer, service agency or the gas supplier.

This is an unvented and vented gas-fired heater. It uses air (oxygen) from the room in which it is installed. Provisions for adequate air for combustion and ventilation must be provided. Refer to Section V.

This appliance may be installed in an aftermarket, permanently located, manufactured home, where not prohibited by local codes.

This appliance is only for use with the type of gas indicated on the rating plate. This appliance is not convertible for use with other gases.

INSTALLER: Leave this manual with the appliance.  
CONSUMER: Retain this manual for future reference.

New Buck Corporation  
PO BOX 69  
200 ETHAN ALLEN DRIVE  
Spruce Pine, NC 28777  
[www.buckstove.com](http://www.buckstove.com)

October 2018



## TABLE OF CONTENTS

SECTION I: Safety Information .....	1
SECTION II: Residential Installation-Unvented Gas Logs .....	4
Clearances .....	5
Gas Connection .....	6
Preparing Log Kit.....	6
Gas Pressure Check.....	8
Lighting Instruction.....	9
Flame Check.....	13
Heat Output .....	13
SECTION III: Installation-Heat Shield.....	14
Wiring Diagram.....	16
SECTION IV: Installation-After Market Permanently Located Manufactured Home .....	18
SECTION V: Producing Adequate Air For Combustion And Ventilation .....	18
Ventilation Air For Combustion And Ventilation From Inside Building .....	21
Ventilation Air For Combustion And Ventilation From Outdoors .....	22
SECTION VI: Vented Logs .....	23
Important Safeguards .....	25
Cleaning.....	25
Trouble-Shooting.....	26
Servicing and Replacement Parts .....	30-31
Warranty .....	34
Owner Registration Card.....	37

# SECTION I

## SAFETY INFORMATION

### WARNINGS

**IMPORTANT: READ THIS OWNER'S MANUAL CAREFULLY AND COMPLETELY BEFORE TRYING TO ASSEMBLE, OPERATE, OR SERVICE THE APPLIANCE. IMPROPER USE OF THESE LOGS CAN CAUSE SERIOUS INJURY OR DEATH FROM BURNS, FIRE, EXPLOSION, AND CARBON MONOXIDE POISONING.**

- **NOTE: When burning any unit or appliance that combusts fuel for heat, such as coal, oil, wood or natural and (L.P.) liquid petroleum gas. We highly recommend the use of smoke and carbon monoxide detectors in your home.**

Early signs of carbon monoxide poisoning resemble the flu, with headaches, dizziness, and nausea. If you have these signs, the heater may not be working properly. Get fresh air at once ! Turn off gas. Have burner serviced. Some people (such as pregnant women, persons with heart or lung disease, persons with anemia, those under the influence of alcohol, and those at high altitudes) are more affected by carbon monoxide than others. Make certain you understand and read all Warnings. Keep this manual for reference. It is your guide to safe proper operation of these logs.

**CAUTION: Strong drafts, such as a ceiling fan placed directly in front of heater (pulling from either direction) may create sooting. Sooting will discolor walls.**

1. Install log set only in a solid-fuel-burning masonry fireplace or U.L. listed prefabricated fireplace constructed of non-combustible materials.
2. The installation and the provision for combustion and ventilation air must conform with local codes or, in the absence of local codes, with the National Fuel Gas Codes, **ANSI Z223.1/ NFPA54**.
3. This appliance may be installed in an After Market\* Manufactured Home, where not prohibited by state or local codes. (\*After Market: Completion of sale, not for purpose of resale from the manufacturer.)

**NOTE: This appliance is only for use with type of gas indicated on the rating plate. This appliance is not convertible for use with other gases.**

**NOTE: See Section IV for After-Market Manufactured Home Installation and Section V Fresh Air For Combustion And Ventilation.**

**IMPORTANT: VENT-FREE HEATERS ADD MOISTURE TO THE AIR. ALTHOUGH THIS IS BENEFICIAL, INSTALLING HEATER IN ROOMS WITHOUT ADEQUATE AIR FOR COMBUSTION AND VENTILATION MAY CAUSE MILDEW TO FORM FROM TOO MUCH MOISTURE.**

4. Never install the log set:
  - in a recreational vehicle.
  - where curtains, furniture, clothing, or other flammable objects are less than 42" from the front of the heater.
  - in high traffic areas or in windy areas.

**NOTE: This log set complies with both the ANSI Z21.11.2-2016 "Unvented Room Heater" and ANSI Z21.60-2017. CSA 2.26-2017 Decorative Appliance For "Solid Fuel Burning Fireplace".**

**"WARNING: ANY CHANGE TO THIS HEATER OR ITS CONTROLS CAN BE DANGEROUS".**

5. Two models are available. One specific model for propane (LP), and one for natural gas. Use the correct gas type for your home. This unit is not field convertible.
6. If these gas logs are for use with propane gas, do not place propane supply tank(s) inside any structure. Locate propane supply tank(s) outdoors.
7. **If you smell gas:**
  - Shut off gas supply.
  - Do not try to light any appliance.
  - Do not touch any electrical switch. Do not use any phone in your building.
  - Immediately call your gas supplier from a neighbor's phone . Follow the gas suppliers instructions.
  - If you cannot reach your gas supplier, call the fire department.
8. This heater shall not be installed in unusually tight construction unless provisions are provided for adequate combustion and ventilation air. See Section V-Producing Adequate Air For Combustion And Ventilation. See page 18.
9. Surface of gas logs becomes very hot when operating. Keep children and adults away from hot surface. Gas logs will remain hot for some time after shutdown. Allow surface to cool before touching.
10. Never place any objects on these gas logs .
11. These gas logs **MUST NOT BE USED** with glass doors in a closed position.
12. If equipped, fresh air dampers must be closed.
13. Keep appliance area clean and free from combustible materials, gasoline, and other flammable vapors and liquids. Keep burner and control compartment clean. See installation and operating instructions accompanying heater.
14. If burner shuts off, do not relight until you provide fresh outside air. If burner keeps shutting off, have unit serviced.
15. An **unvented** room heater having input rating of more than **10,000 BTU per hour** shall **not** be installed in a **bedroom** or **bathroom**.
16. Maintain clearance around air openings.
17. Do not use the appliance if any part has been under water. Immediately call a qualified service technician to inspect the appliance and to replace any part of control system and any gas control which has been under water.
18. Turn off the gas logs and let cool before servicing.

**WARNING**

**This appliance is equipped for (natural or propane) gas.  
Field conversion is not permitted.**

19. Make sure any safety screen or guard (if any) that was removed for servicing is in place before operating gas logs.
20. Strong drafts, such as a ceiling fan placed directly in front of the fireplace, may create sooting. Sooting may discolor walls.
21. Installation and repair should be done by a qualified service person. The heater and the gas logs should be inspected before use and at least annually by a professional service person. More frequent cleaning may be required due to excessive lint from carpeting, bedding materials, etc. It is important that the control compartment, burners, and circulating air passageways of these gas logs be kept clean and clear.
22. Do not use these gas logs for burning trash or cooking. Never place matches, paper, garbage, or any other material on top of logs or into the flames.
23. Do not install or operate these gas logs in areas where impurities in the air exist (such as tobacco smoke and heavy cooking grease). Particles from impurities may discolor walls.
24. The appliance and its individual shut off valve must be disconnected from the gas supply piping system during any pressure testing of that system at test pressures in excess of 1/2 psi (3.5 kPa).
25. The appliance must be isolated from the gas supply piping system by closing its equipment shut off valve during any pressure testing of the gas supply piping system at test pressure equal to or less than 1/2 psi (3.5 kPa).
26. Any outside air ducts and / or ash dumps in the fireplace shall be permanently closed at time of appliance installation.
27. Due to high temperatures, the appliance should be located out of traffic and away from furniture and draperies.
28. Do not place clothing or other flammable materials on or near the appliance.
29. The logs are made of light weight refractory. Hold both ends of the log when removing or replacing.
30. This appliance is intended for supplemental heating.
31. Children and adults should be alerted to the hazard of high surface temperature and should stay away to avoid burns or clothing ignition.
32. Young children should be carefully supervised when they are in the same room with the appliance.

**WARNING: State or local codes may only allow operation of this appliance in a vented configuration. Check your state on local codes.**

## SECTION II

# RESIDENTIAL INSTALLATION OF GAS LOGS

## FIREPLACE PREPARATION

The fireplace needs to be prepared before installing the gas logs.

- A. Turn off the gas supply to the fireplace.
- B. Any outside air ducts on the fireplace shall be permanently closed at the time of the appliance installation.

**WARNING: BEFORE INSTALLING IN A SOLID FUEL BURNING FIREPLACE, THE CHIMNEY FLUE AND FIREBOX MUST BE CLEANED OF SOOT, CREOSOTE, ASHES AND LOOSE PAINT BY A QUALIFIED CHIMNEY CLEANER.**

**WARNING: DO NOT ALLOW FANS TO BLOW DIRECTLY INTO THE FIREPLACE. AVOID ANY DRAFTS THAT ALTER BURNER FLAME PATTERN.**

## LOCATION

Centrally locate the gas logs in the fireplace. Place them deep enough into the fireplace to accomplish adequate draft (if use as a vented gas log set is planned). Ensure that front of the logs sit inside the edge of the fireplace.

**NOTE: IF THE EXISTING FIREPLACE IE EQUIPPED WITH A SCREEN IT MUST BE IN PLACE WHEN THE APPLIANCE IS OPERATING . THE SCREEN SHALL HAVE ADEQUATE OPENING (S) FOR INTRODUCTION OF AIR FOR COMBUSTION AND VENTILATION.**

**NOTE: MAINTAIN PROPER CLEARANCE FOR PURPOSE OF SERVICING, PROPER INSTALLATION, AND OPERATION.**

ANGLE MANTEL

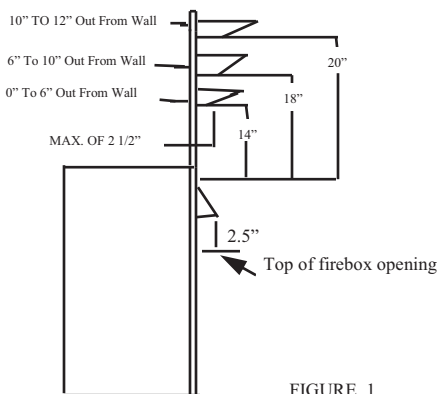
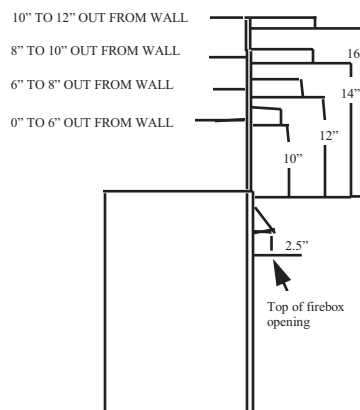

FIGURE 1

FLAT MANTEL



Mantel minimum clearances for a listed Zero Clearance Firebox or a Masonry Fireplace.

**\*WARNING: Canopy model MAPSFPC must be used at all times unless a 10-inch mantel is installed at 36-inches above the fireplace opening. (Can be obtained from your local dealer or purchased from the factory.)**

**WARNING: THIS APPLIANCE IS FOR INSTALLATION ONLY IN A SOLID FUEL BURNING MASONRY OR UL127 FACTORY BUILT FIREPLACE OR IN A LISTED VENTLESS FIREBOX ENCLOSURE.**

**IT HAS BEEN DESIGN CERTIFIED FOR THESE INSTALLATIONS . EXCEPTION: DO NOT INSTALL THIS APPLIANCE IN A FACTORY BUILT FIREPLACE THAT INCLUDES INSTRUCTIONS STATING IT HAS NOT BEEN TESTED OR SHOULD NOT BE USED WITH UNVENTED GAS LOGS.**

## **INSTALLATION AND CLEARANCES**

To ensure a safe installation into an existing solid fuel burning fireplace, the following instructions must be carefully followed.

NOTE: Gas control knobs are located in lower front center of base. “OFF/PILOT/ON” is the Right knob, Thermostat adjustment is the Left knob..

**1. Side wall Clearances:**

Clearance from the right and left side of the fireplace opening to any adjacent combustible wall should not be less than 12”.

**2. Ceiling Clearance:**

The ceiling height should not be less than 42” from the top of the fireplace opening.

**3. Mantel Clearance:**

Clearances from top of heater to mantel or mantel supports. See Figure 1.

**4. Front Clearances:**

No objects should be placed within 24” from the front of the fireplace opening.

**MINIMUM FIREPLACE DIMENSIONS FOR CR8T LOG SET MANUFACTURED BY NEW BUCK CORPORATION FOR SOLID FUEL BURNING FIREPLACE OR MASONRY FIREPLACE AND PREFAB OR MANUFACTURED FIREPLACES.**

NOTE: When using CR8T log set with the Model 19HS heat shield see page 14 for clearances.

<b>MODEL</b>	<b>HEIGHT OF OPENING</b>	<b>WIDTH OF OPENING AT FRONT</b>	<b>WIDTH AT REAR</b>	<b>DEPTH OF FIREPLACE</b>
<b>CR8T</b>	<b>17”</b>	<b>24”</b>	<b>18”</b>	<b>10”</b>

**WARNING: ANY CHANGE TO THIS HEATER OR ITS CONTROLS CAN BE DANGEROUS.**

**WARNING: ‘ CUTTING ANY SHEET METAL PARTS OF THE SOLID-FUEL BURNING FIREPLACE OR LISTED VENTLESS FIREBOX ENCLOSURE IN WHICH THE UNVENTED FIREPLACE INSERT (LOG SET) IS TO BE INSTALLED IS PROHIBITED.’**

NOTE: Smoke shelves, shields and baffles may be removed if attached by mechanical fasteners.

NOTE: Refractory, glass doors, screen rails, screen mesh and solid-fuel log grates (if applicable) can be removed from the fireplace before installing the unvented fireplace insert.



## GAS CONNECTION

Check gas type. Use only the type of gas indicated on the valve rating plate. If the type of gas listed on the plate is not your type of gas supply, **DO NOT INSTALL**. Contact your dealer for proper model.

Always use an external regulator for all LP heaters to reduce the supply tank pressure to a maximum of 13" W.C. This is in addition to the regulator furnished with the heater.

**Warning: Connection directly to an unregulated LP tank can cause an explosion.**

The normal gas connection is 3/8" N.P.T. made at the right side facing the log set. If a left side connection is desired, the connecting pipe may be routed under the rear of the burner base to terminate at the right hand side for connection to the inlet of the valve.

**NOTE:** The connecting pipe must be internally tinned copper tubing for use with natural gas. Test for leaks using a solution of soap and water after completing the connection.

**DO NOT USE OPEN FLAME.**

**NOTE:** "If the factory-built fireplace has no gas access hole(s) provided, an access hole of 1.5 inch (37.5mm) diameter or less may be drilled through the lower sides or bottom of the firebox. This access hole must be plugged with non-combustible insulation after gas supply line has been installed.

## PREPARING LOG KIT

Open the cartons containing the Burner Base and the Logs. Inside one of the cartons you will find the Burner Base. The Logs are boxed separately.

**CR8T (1) REAR LOG (2) FRONT LOG (3) LEFT TOP LOG**

**WARNING:** POSITIONING OF LOGS IS VERY CRITICAL (FIGURE 2).

LOG PLACEMENT FOR CR8T LOG SET.

1. Place Rear log #1 on rear log support. The log has alignment notch on left and right corners.
2. Place Front log #2 with alignment notches over front andirons.
3. Left Top log has locating hole in one end, place hole over pin on Left side of Rear log (#1). Make sure Front of Left Top log (#3) is resting on Left side of Left Andiron.

**Solid fuels shall not be burned in the same fireplace where an unvented room heater has been installed.**

**NOTE:** The following label has been provided with this appliance and must be read and then attached to the floor of the fireplace firebox area beneath the appliance. The label is a peel and stick label. Make sure the area is cleaned before attaching the label to it.

**WARNING:** This solid-fuel burning fireplace or listed ventless enclosure has been converted for use with an unvented fireplace insert only. A solid-fuel burning fireplace cannot be used for burning wood or solid fuels unless all original parts have been replaced, and the fireplace re-approved by the authority having jurisdiction. A ventless firebox enclosure cannot be used with an unvented gas log unless all original parts have been replaced, and the ventless firebox enclosure re-approved by the authority having jurisdiction.

## CR8T LOG PLACEMENT DIAGRAM

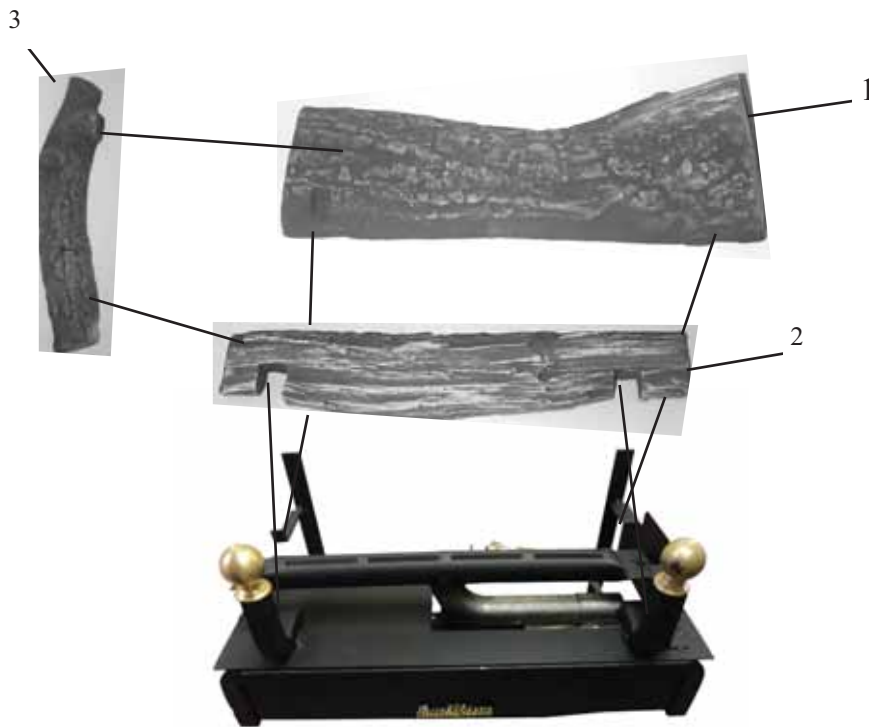

Figure 2

Refer to PREPARING LOG KIT page 6.

**WARNING:** Failure to position the parts in accordance with these diagrams or failure to use only parts specifically approved with this heater may result in property damage or personal injury.

## GAS PRESSURE CHECK

Check the inlet pressure to the burner to ensure that it is as shown in the table below.

**NOTE:** The pressure check point is located on right side of valve facing the burner.

The appliance and its main gas valve must be disconnected from the gas supply piping system during any pressure testing of that system at test pressures in excess of 1/2 psi (3.5kPa).

The appliance must be isolated from the gas supply piping system by closing its equipment shut-off valve during any pressure testing of the gas supply piping system at test pressures equal to or less than 1/2 psi (3.5 kPa).

### **MODEL CR8T**

Gas	Natural	Propane (LP)
Maximum Heat Input	27,000	27,000
Minimum Heat Input	11,000	11,000

### Gas Inlet Pressure:

Maximum	10.5 ins. W.C.	13.0 ins. W.C.
Minimum	5 ins. W.C.	11 ins. W.C.
Manifold Pressure	3.5 ins. W.C.	10 ins. W.C.

**NOTE:** On initial installation it may be required to bleed out air in the gas lines. Do this by holding the knob and turning the knob to the pilot position for about 30 seconds.

The pressure should be checked with the heater burning and the control set on high. After measuring the pressure, close pressure tap screw, ensuring there are no leaks. Regulator pressure check screw located above “OFF/ PILOT/ ON” knob at right upper corner of valve.

### **WARNING**

**This appliance equipped for (natural or propane) gas.  
Field conversion is not permitted.**

## **OPERATING INSTRUCTIONS**

Before operating this appliance, proceed through the following checklist

1. Read and understand these instructions before operating this appliance.
2. Check that there no leaks. If you smell gas do not attempt to light this appliance.
3. Verify that log placement is correct.

### **LIGHTING INSTRUCTIONS MODULATING VALVE(MAXITROL) FOR YOUR SAFETY, READ BEFORE LIGHTING**

#### **WARNING**

**IF YOU DO NOT FOLLOW THESE INSTRUCTIONS EXACTLY, A FIRE OR EXPLOSION MAY RESULT CAUSING PROPERTY DAMAGE, PERSONAL INJURY OR LOSS OF LIFE.**

- A. This appliance has a pilot which must be lit by hand. When lighting the pilot, follow these instructions exactly.
- B. **BEFORE LIGHTING:** Smell all around the appliance for gas. Be sure to smell next to the floor because gas is heavier than air and will settle on the floor.

#### **WHAT TO DO IF YOU SMELL GAS**

- \* Do not try to light any appliance.
  - \* Do not touch any electrical switch. Do not use any phone in your building.
  - \* Immediately call your gas supplier from a neighbor's phone. Follow the gas supplier's instructions.
  - \* If you cannot reach your gas supplier, call your local fire department.
- C. Use only your hand to push in or turn the gas control knob. Never use tools. If the knob will not push in or turn by hand, don't try to repair it, call a qualified service technician. Force or attempted repair may result in fire or explosion.
  - D. Do not use this appliance if any part has been under water. Immediately call a qualified service technician to inspect the appliance and to replace any part of the control system and any gas control which has been under water.

## LIGHTING INSTRUCTIONS

1. STOP! Read the safety information on the previous page.
2. Make sure manual shutoff valve is fully **closed**.
3. Open access panel door, located in lower front center of base for access to control knobs.
4. Turn off all electric power to the appliance.
5. Set thermostat (flame control) to lowest setting.
6. Push in and turn control knob clockwise  to the “OFF” position.

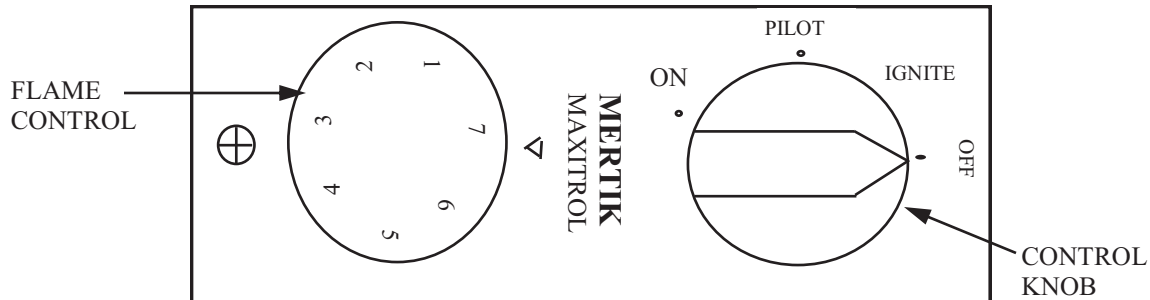





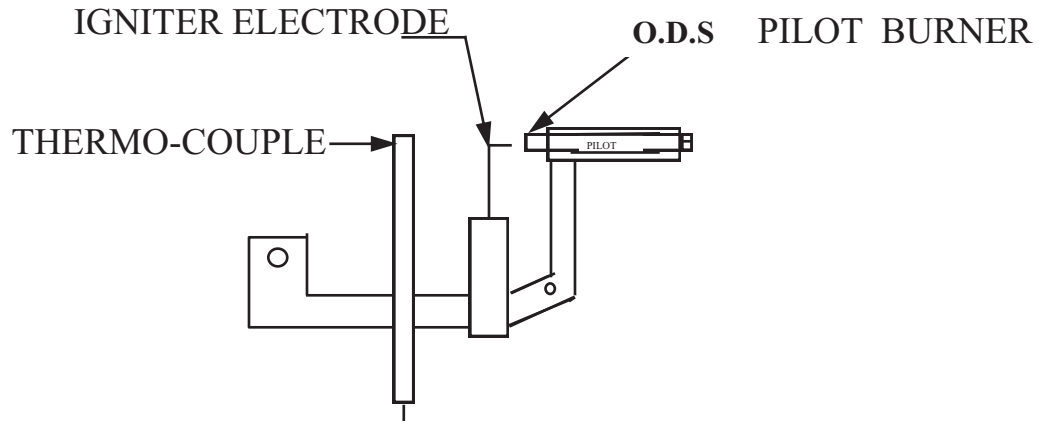

FIGURE 3

7. Wait (5) five minutes to clear out any gas. Then smell for gas, including near the floor. If you smell gas, STOP! Follow step “B” in the safety information on the previous page. If you don’t smell gas, go to the next step.
8. Find Pilot: follow the small metal tub from the right hand rear of the gas control valve. The pilot is located behind the burner tub and in front of the rear log. Fully **open** the manual shut-off valve.
9. Turn control knob counterclockwise  to the “PILOT” position. Press in control knob for (15) fifteen seconds (see figure 3).
10. With control knob pressed in, turn control knob clockwise  to **IGNITE** and then **immediately back** to **PILOT** with the button still pressed in. This will light the pilot. If needed, keep repeating this step until pilot lights.
11. Keep control knob pressed in for one (1) minute after lighting pilot. After (1) minute, release the control knob. If pilot goes out, repeat steps 1 through 9.
  - If the knob does not pop up when released, stop and immediately call your service technician or gas supplier.
  - If the pilot will not stay lit after several tries, turn the gas control knob to “OFF” and call your service technician or gas supplier.
12. Turn control knob counterclockwise  to “ON” position.
13. Set thermostat (flame control) to desired setting. Turn clockwise  for “LOW” and counterclockwise  for “HIGH”.



13. Close the access panel door.
14. Turn on all electric power to the appliance.

**CAUTION**

**DO NOT TRY TO ADJUST HEATING LEVELS BY USING THE MANUAL SHUTOFF VALVE.**

**TO TURN OFF GAS TO APPLIANCE**

**SHUTTING OFF UNIT:**

1. Open access panel door, located in lower front center of base for access to control knobs.
2. Set thermostat (flame control) to lowest setting.
2. Turn control knob clockwise to the full "OFF" position.
3. Turn off all electrical power to the appliance if service is to be performed.
4. Close access panel door.

**SHUTTING OFF BURNER ONLY (pilot stays lit)**

1. Open access panel door, located in lower front center of base for access to control knobs.
2. Turn control knob clockwise to the "PILOT" position.
2. Close access panel door.

**CAUTION:** Hot while in operation. Do Not Touch. Keep children, clothing, furniture, gasoline, and other liquids having flammable vapors away.

**CAUTION:** DO NOT TRY TO ADJUST HEATING LEVELS BY USING THE MANUAL SHUTOFF VALVE.

**WARNING:** Improper installation, adjustment, alteration, service or maintenance can cause property damage, personal injury, or loss of life. Refer to owner's information manual provided with this appliance. Installation and service must be performed by a qualified installer, service agency, or the gas supplier.





**IMPORTANT:** Always operate the appliance at the completely "ON" or the completely "OFF" positions. Never use the heater at a setting between these positions as this can result in improper combustion and excessive carbon monoxide emissions.

## THERMOSTAT CONTROL OPERATION

The thermostat control used on this heater differs from standard thermostats. Standard thermostats simply turn the burner on and off. The thermostat used on this heater senses the room temperature and adjusts the amount of gas flow to the burner. This will increase or decrease the flame height. At times, the room may exceed the set temperature, which will cause the burner to shut off. When room temperature drops below the thermostat setting, the burner will cycle itself on again. The flame control knob can be set to any level between 2 and 7.

**NOTE:** The thermostat sensing bulb measures the temperature of air near the heater cabinet. This may not always agree with room temperature ( depending on housing construction, installation location , room size, open air temperature, etc.). Frequent use of your heater will allow you to determine your personal comfort levels.

## MANUAL LIGHTING PROCEDURE

1. If the pilot cannot be ignited with the igniter on the control valve, it can be manually lit with the use of a paper match and a lighter rod.
2. Place the match in the holder and light. With other hand, depress the control knob counterclockwise  to PILOT.
3. Use rod to light match and ignite pilot. The pilot is located behind the burner tub and in front of the rear log. Fully **open** the manual shut-off valve.
4. Continue to hold the control knob for an additional (1) one minute to ensure the pilot is completely on.
  - If the knob does not pop up when released, stop and immediately call your service technician or gas supplier.
  - If the pilot will not stay lit after several tries, turn the gas control knob to “OFF” and call your service technician or gas supplier.
5. Turn control knob counterclockwise  to “ON” position.  
-Set thermostat (flame control) to desired setting. Turn clockwise  for “LOW” and counterclockwise  for “HIGH”.
6. Close the access panel door.
7. Turn on all electric power to the appliance.

## BURNER & PILOT FLAME CHECK

A periodic check of the flames should be made. The flame should always be present when the gas logs are in operation.

Flames: The flame should extend about 3” to 4” above the rear log for natural gas. For propane (LP) gas, the flame should be about 6”.

### CR8T LOGS & BASE

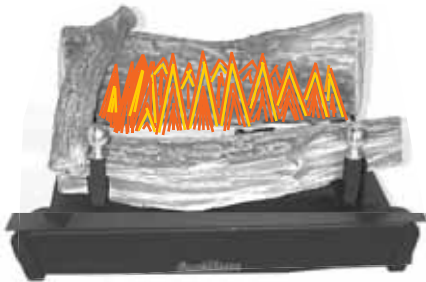

### PILOT

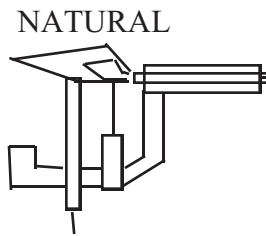

### PROPANE

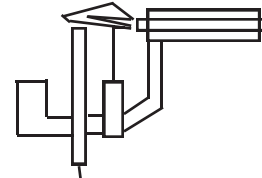

Figure 4

## WHEN USED AS A HEATING APPLIANCE HEAT OUTPUT

The heat output into the room can be controlled by the position of the flue damper, when used as “Vented Gas Logs”. See Section VI-Vented Models.

The gas logs may be used as non-vented gas logs only where permitted by local state and city codes. If non-vented gas logs are not permitted, then the fireplace vent area required by local codes must be met. **The installation must conform with local codes or, in the absence of local codes, with the National Fuel Gas, ANSI Z223.1/NFPA 54. Check your state or local codes.**



## SECTION III INSTALLATION OF LOG SET WITH (OPTION ) HEAT SHIELD MODEL 19HS

For installation of gas supply see “Fireplace and Gas Connection” Page 6, Section II.

**NOTE:** The same clearances for the log set are also used with the 19 Heat Shield.

See Page 4, Section II, Figure 1.

**NOTE:** Centrally locate the Heat Shield in the fireplace and place it deep enough into the fireplace to accomplish adequate draft (if use as a vented heater is planned). Ensure that the Heat Shield front is inside the front edge of the fireplace , see Figure 5. Using the screws and anchors provided, fasten the Heat Shield to the floor of the fireplace. On each side of floor frame of the Heat Shield base, there is a “go through hole”. Position the Heat Shield as described above. Mark the hole for drilling. See Figure 5.

**NOTE:** When using CR8T LOG SET with optional Heat Shield the following minimums must be met.

**FRONT 24”    REAR 23”    HEIGHT 20”    DEPTH 19 1/2”**

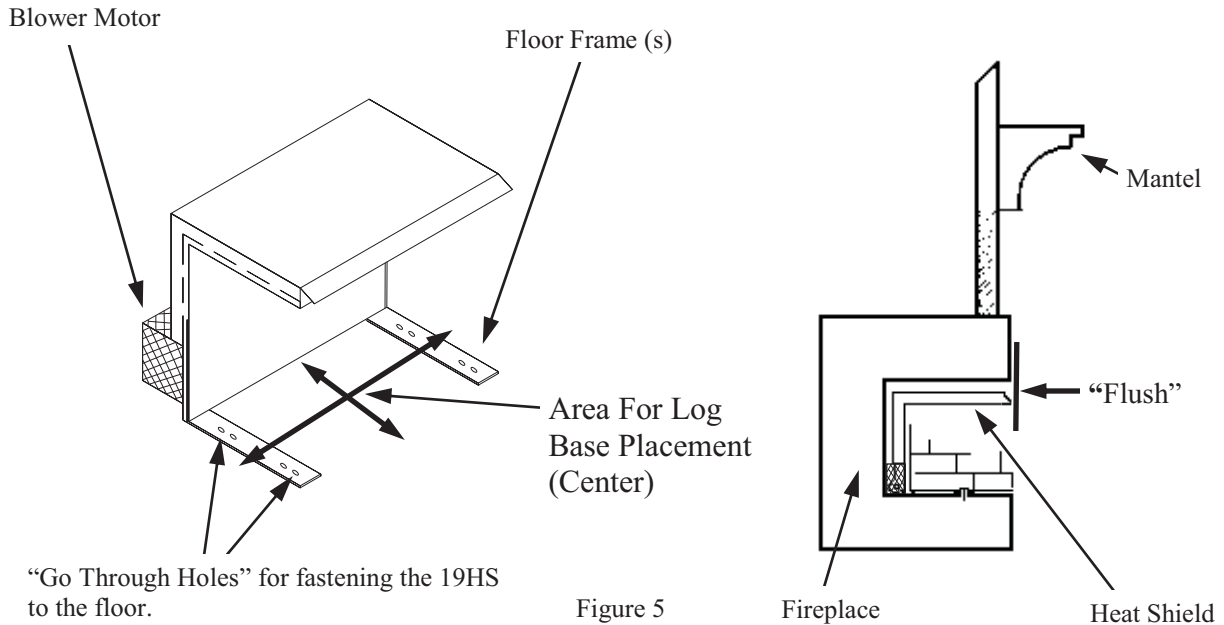

Figure 5

Follow log positioning in Section II.

**NOTE:** For the first few hours of burning, you will have paint and burning smell. It is recommended to leave the fan off during this period. You may also want to raise a window or open the doors.

## REPLACEMENT PARTS

### FOR (OPTIONAL) HEAT SHIELD MODEL 19HS

Always include correct name, part number, and model number when ordering service Parts.

KEYS#	PART DESCRIPTION	PART NUMBER
1.	BLOWER RATING:120volts/60HZ/ .54Amps	PEA2-40-01
2.	110 THERMOSTAT	PE400132
3.	CHROME SHIELD	POHS14
4.	POWER CORD	PE400240

**WARNING:** CHILDREN AND ADULTS SHOULD BE ALERTED TO THE HAZARDS OF HIGH SURFACE TEMPERATURES AND SHOULD STAY AWAY TO AVOID BURNS OR CLOTHING IGNITION. YOUNG CHILDREN SHOULD BE CAREFULLY SUPERVISED WHEN THEY ARE IN THE SAME ROOM AS THESE GAS LOGS.

**WARNING:** Clothing or other flammable material should not be placed on or near this appliance.

## WIRING DIAGRAM

(FOR OPTIONAL HEAT SHIELD MODEL 19HS )

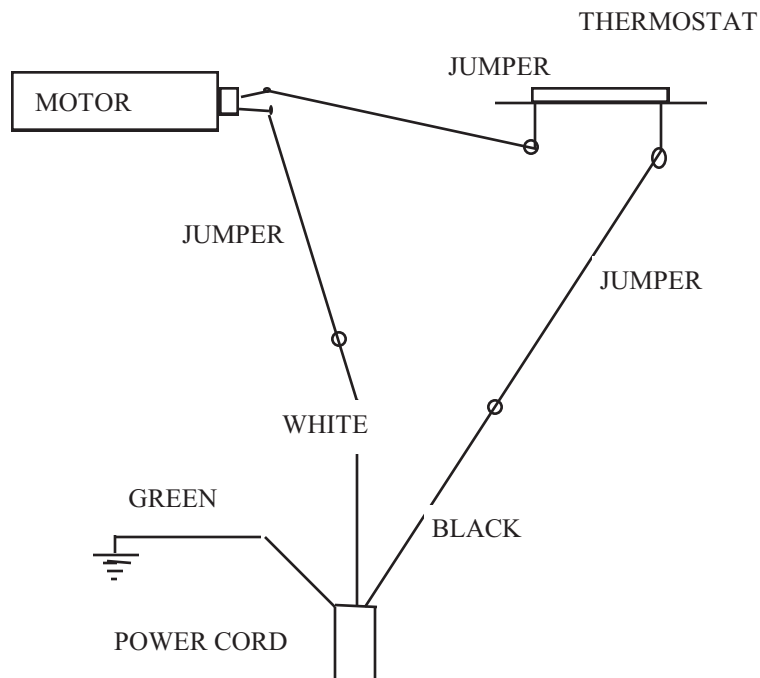

**NOTE:** If any of the original wire supplied with the appliance must be replaced, it must be replaced with a wire of at least a 105° C. temperature rating.

**NOTE:** Installation and repair should be done by a qualified service person. This heater should be inspected before use and at least annually by a qualified service person. More frequent cleaning may be required due to excessive lint from carpeting, bedding material, etc. It is imperative that control compartments and circulating air passageways of the heater be kept clean.

**CAUTION:** Label all wires prior to disconnection when servicing controls. Wiring errors can cause improper and dangerous operation.

Verify proper operation after servicing.

**WARNING:** ELECTRICAL GROUNDING INSTRUCTION: THIS APPLIANCE IS EQUIPPED WITH A THREE-PRONG GROUNDING PLUG FOR YOUR PROTECTION AGAINST SHOCK HAZARD. IT SHOULD BE PLUGGED DIRECTLY INTO A PROPERLY GROUNDED THREE-PRONG RECEPTACLE.

**WARNING:** DO NOT USE A BLOWER INSERT, HEAT EXCHANGER INSERT OR OTHER ACCESSORIES NOT APPROVED FOR USE WITH THIS HEATER.

**WARNING:** THE MOTOR IS PERMANENTLY LUBRICATED. DO NOT ADD ANY TYPE OF LUBRICANT.

## SECTION IV

### AFTER-MARKET MANUFACTURED HOME INSTALLATION

**THIS APPLIANCE MAY BE INSTALLED IN AN AFTERMARKET\*, PERMANENTLY LOCATED, MANUFACTURED HOME, WHERE NOT PROHIBITED BY LOCAL CODES. \*After Market: Completion of sale, not for the purpose of resale from the manufacturer. THIS APPLIANCE IS ONLY FOR USE WITH THE TYPE OF GAS INDICATED ON THE RATING PLATE. THIS APPLIANCE IS NOT CONVERTIBLE FOR USE WITH OTHER GASES.**

**NOTE:** FOR AFTER-MARKET MANUFACTURED HOME INSTALLATION FOLLOW RESIDENTIAL INSTALLATION. SECTION II, PAGE 4.

## SECTION V

### PRODUCING ADEQUATE AIR FOR COMBUSTION AND VENTILATION

**NOTE:** This heater shall not be installed in a room or space unless the required volume of indoor combustion air is provided by the method in the *National Fuel Gas Code, ANSI Z223.1/NFPA 54*, the *International Fuel Gas Code*, or applicable codes.

*The National Fuel Gas Code, ANSI Z223.1/NFPA 54* defines unusually tight construction or unconfined space as a space whose volume is less than 50 cubic feet per 1,000 BTU per hour (4.8m<sup>3</sup> per kw) of the aggregate input rating of all appliances installed in that space and an unconfined space as a space whose volume is not less than 50 cubic feet per 1,000 BTU per hour (4.8m<sup>3</sup> per kw) of the aggregate input rating of all appliances installed in that space. Rooms communicating directly with the space in which the appliances are installed, through openings not furnished with doors, are considered a part of the unconfined space.

**WARNING: IF THE AREA IN WHICH THE HEATER MAY BE OPERATED DOES NOT MEET THE REQUIRED VOLUME FOR INDOOR COMBUSTION AIR, COMBUSTION AND VENTILATION AIR SHALL BE PROVIDED BY ONE OF THE METHODS DESCRIBED IN THE NATIONAL FUEL GAS CODE, ANSI Z223.1/NFPA 54, THE INTERNATIONAL FUEL GAS CODE, OR APPLICABLE CODES.**

**WARNING: IF THE AREA IN WHICH THE HEATER MAY BE OPERATED IS SMALLER THAN THAT DEFINED AS AN UNCONFINED SPACE OR IF THE BUILDING IS OF UNUSUALLY TIGHT CONSTRUCTION, PROVIDE ADEQUATE AIR FOR COMBUSTION AND VENTILATION BY ONE OF THE METHODS DESCRIBED IN THE NATIONAL FUEL GAS CODE, ANSI Z223.1/NFPA 54 AIR FOR COMBUSTION AND VENTILATION, OR APPLICABLE LOCAL CODES.**

Unusually tight construction is defined as construction where:

- a) Walls and ceilings exposed to the outside atmosphere have a continuous water vapor retarder with a rating of 1 perm ( $6 \times 10^{-11}$  kg per pa-sec-m<sup>2</sup>) or less with openings gasketed or sealed.
- b) Weather stripping has been added on openable windows and doors.
- c) Caulking or sealants are applied to areas such as joints around window and door frames, between sole plates and floors, between wall-ceiling joints, between wall panels, at penetrations for plumbing, electrical, and gas lines, and at other openings.

# NOTICE

**SOME AREAS IN THE UNITED STATES HAVE HIGHER REQUIREMENTS FOR CUBIC FEET PER 1000 BTU/ HOUR INPUT. (EX. CINCINNATI, OHIO CODES REQUIRE 70 CUBIC FEET). CHECK YOUR LOCAL CODE BEFORE INSTALLATION.**

## DETERMINING FRESH-AIR FLOW FOR HEATER LOCATION

DETERMINE IF YOU HAVE UNUSUALLY TIGHT CONSTRUCTION OR UNCONFINED SPACE.

Use this worksheet to determine if you have unusually tight construction or unconfined space.

SPACE: Includes the room in which you install the heater plus adjoining rooms with door less passageways or ventilation grills between the rooms.

**1. Determine the volume of the space (length x width x height).**

Length x Width x Height = \_\_\_\_\_ cu. ft. (volume of space)

EXAMPLE: 20 ft. (length) x 16 ft. (width) x 8 ft. (ceiling Height) =  
2560 cu. ft. (volume of space)

If additional ventilation to adjoining room is supplied with grills or openings, add the volume of these rooms to the total volume of the space.

**2. Divide the space volume by 50 cubic feet to determine the maximum BTU/Hr the space can support.**

\_\_\_\_\_ (volume of space) / 50 cu. Ft.= maximum BTU/Hr the space  
can support)

EXAMPLE: 2560 cu. Ft. (volume of space /50 cu. Ft.=51.2 or  
51200 (maximum BTU/Hr the space can support)

**3. Add the BTU/Hr of all fuel burning appliances in the space.**

Vent-free Heater	_____	BTU/Hr
Gas Water Heater*	_____	BTU/Hr
Gas Furnace	_____	BTU/Hr
Vented Gas Heater	_____	BTU/Hr
Gas Fireplace Logs	_____	BTU/Hr
Other Gas Appliances*	+ _____	BTU/Hr
TOTAL	= _____	BTU/Hr

EXAMPLE: Gas Water Heater 40,000 BTU/Hr  
Vent-Free Heater +18,000 BTU/Hr  
TOTAL = 58,000 BTU/Hr

\*DOES NOT INCLUDE DIRECT-VENT GAS APPLIANCES. DIRECT-VENT DRAWS COMBUSTION AIR FROM OUTDOORS AND VENTS TO THE OUTDOORS.

4. Compare the maximum BTU/Hr the space can support with the actual amount of BTU/Hr used.

\_\_\_\_\_ BTU/Hr (maximum the space can support)  
\_\_\_\_\_ BTU/Hr ( actual amount of BTU/Hr used)

EXAMPLE: 51200BTU/Hr (maximum the space can support)  
58000BTU/Hr (actual amount of BTU/Hr used)

The space in the above example is unusually tight construction because the actual BTU/Hr used is more than the maximum BTU/Hr the space can support. You must provide additional fresh air .

Your options are as follows:

- A. Rework worksheet, adding the space of an adjoining room. If the extra space provides an unconfined space, remove door to adjoining room or add ventilation grills between rooms. See “Ventilation Air For Combustion And Ventilation From Inside Building”, page 21.
- B. Vent room directly to the outdoors . See “Ventilation For Combustion And Ventilation From Air Outdoors”, page 22.
- C. Install a lower BTU/Hr heater , if lower BTU/Hr size makes room unconfined.

If the actual BTU/Hr used is less than the maximum BTU/Hr the space can support, the space is an unconfined space. You will need no additional fresh air ventilation.

## WARNING

**YOU MUST PROVIDE ADDITIONAL VENTILATION AIR IN  
UNUSUALLY TIGHT CONSTRUCTION**

## VENTILATION AIR FOR COMBUSTION AND VENTILATION FROM INSIDE BUILDING

This fresh air would come from an adjoining unconfined space. When ventilating to an adjoining space, you must provide two permanent openings: one within 12" of the ceiling and one within 12" of the floor on the wall connecting the two spaces (See options 1 and 2, Figure 6). You can also remove door into adjoining room (See option 3, Figure 6).

### WARNING

REWORK WORKSHEET, ADDING THE SPACE OF THE ADJOINING UNCONFINED SPACE. THE COMBINED SPACES MUST HAVE ADEQUATE AMOUNT OF AIR TO SUPPLY ALL APPLIANCES IN BOTH SPACES.

**NOTE:** Each opening shall have a minimum free area of 1 square inch per 1000 BTUs per hour of the total input rating of all gas utilization equipment in the confined space, but not less than 100 square inch.

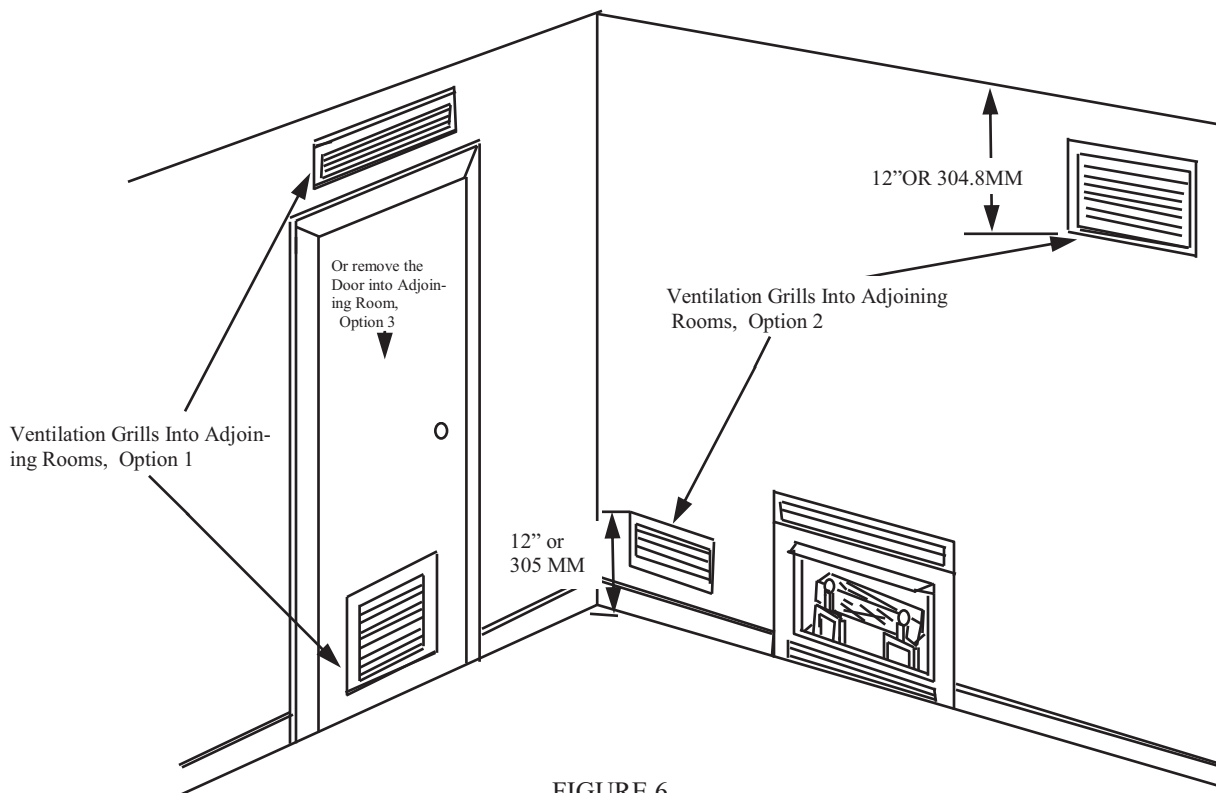

FIGURE 6

**NOTE:** This heater shall not be installed in a room or space unless the required volume of indoor combustion air is provided by the method in the *National Fuel Gas Code, ANSIZ223.1/ NFPA 54*, the *International Fuel Gas Code*, or applicable codes.





## WARNING

THIS HEATER MUST HAVE ADEQUATE AMOUNT OF AIR FOR PROPER OPERATION. IF NOT, POOR FUEL COMBUSTION COULD RESULT. READ THE FOLLOWING INSTRUCTIONS TO ENSURE PROPER AMOUNT OF AIR FOR THIS AND OTHER FUEL-BURNING APPLIANCES IN YOUR HOME.

## VENTILATION AIR FOR COMBUSTION AND VENTILATION FROM OUTDOORS

Provide extra fresh air by using ventilation grills or ducts. You must provide two permanent openings: one within 12" of the ceiling and one within 12" of the floor. Connect these items directly to the outdoors. These spaces include attics and crawl spaces. Follow the National Fuel Codes NFPA 54/ANSI Z223.1, Section 5.3, Air For Combustion and Ventilation for required size of ventilation grills or ducts.

**IMPORTANT:** Do not provide openings for inlet air into attic if attic has a thermostat—controlled power vent. Heated air entering the attic will activate the power vent.

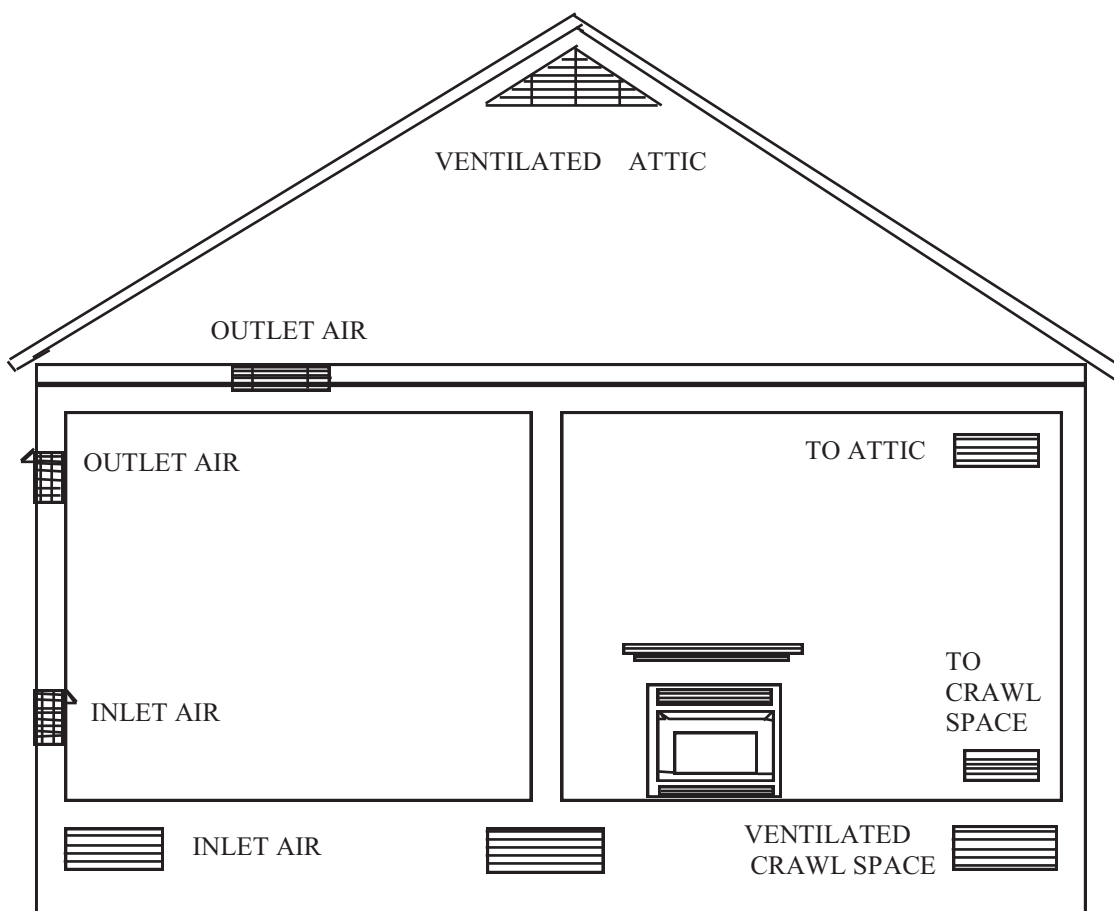

FIGURE 7

## SECTION VI VENTED

- (1) This appliance must be installed only in a solid-fuel burning fireplace with a working flue and constructed of non-combustible materials.
- (2) A minimum of 25.7 sq. in. (Min. 6" chimney) or see page 24, permanent flue opening must be provided by either the fireplace chimney or chimney damper to vent the flue gases.
- (3) Obtain a Damper Flap Lock from your dealer or manufacture. Adjust the Lock on the side of the damper flap in position to maintain a permanent opening of 25.7 sq. in. and lock in place.
- (4) Solid fuels shall not be burned in a fireplace where a decorative appliance is installed.

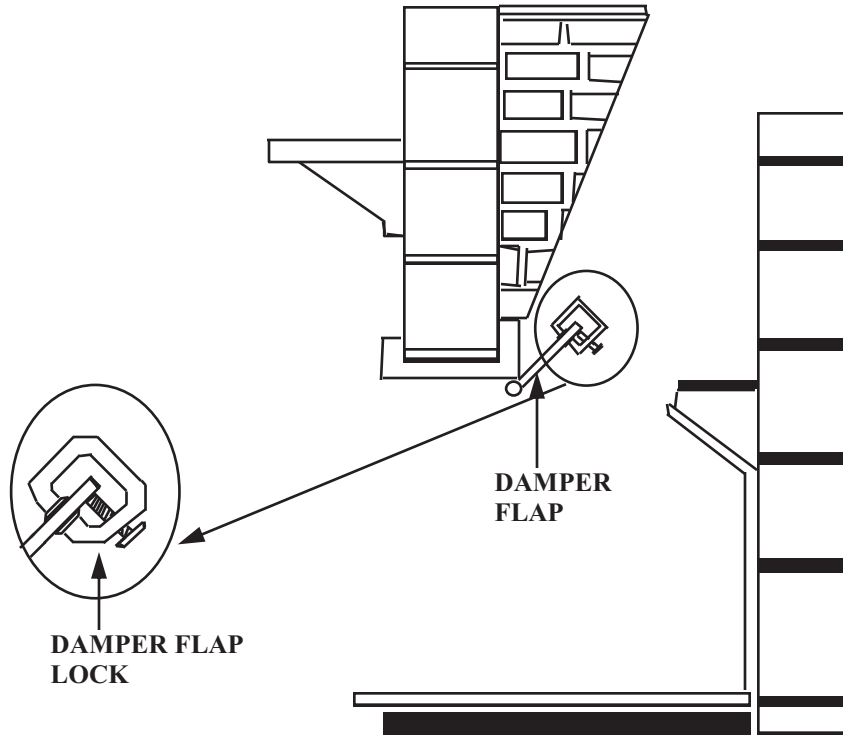

FIGURE 8

- (5) Any chimney damper must be fixed in a manner which will maintain the minimum permanent vent opening at all times.

**NOTE:** See chart on page 24.

- (6) Periodic cleaning of the venting system of a solid fuel burning fireplace should be done by a qualified agency. Clean once a year. Periodic examination and cleaning of the venting system of a solid fuel burning fireplace should be done once a year.

**MINIMUM FIREPLACE DIMENSIONS FOR CR8T LOG SET MANUFACTURED BY NEW BUCK CORPORATION FOR SOLID FUEL BURNING FIREPLACE OR MASONRY FIREPLACE AND PREFAB OR MANUFACTURED FIREPLACES.**

MODEL	HEIGHT OF OPENING	WIDTH OF OPENING AT FRONT	WIDTH AT REAR	DEPTH OF FIREPLACE
CR8T	17"	24"	18"	10"

(7) See: GAS PRESSURE CHECK, page 8.

(8) See: OPERATING INSTRUCTIONS, pages 9-12.

(9) See: BURNER & PILOT FLAME CHECK, for proper flame pattern, page 13.

(10) See: CLEANING INSTRUCTIONS, page 13-25.

NOTE: Visually check the pilot and burner flames annually, and monthly during seasons that the appliance is operating frequently. See page 13.

NOTE: The installation of appliances designed for manufactured home (US only) or mobile home installation must conform with the Standard CAN/CSA Z240 MH, Mobile Housing, in Canada, or with the Manufactured Home Construction and Safety Standard, Title 24 CFR, Part 3280, in the United States, or when such a standard is not applicable, ANSI/NCSBCS A225.1/NFPA 501A, Manufactured Home Installations Standard.

**WARNING: Do not use this appliance if any part has been under water. Immediately call a qualified service technician to inspect the appliance and to replace any part of the control system and any gas control which has been under water.**

**WARNING: Keep the appliance area clear and free from combustible materials, gasoline and other flammable vapors and liquids.**

When using as a vented log set, refer to chart below to calculate minimum damper opening.  
**FOR MASONRY BUILT FIREPLACES FREE OPENING AREA OF CHIMNEY DAMPER FOR VENTING COMBUSTION PRODUCTS FROM DECORATIVE APPLIANCES FOR INSTALLATION IN SOLID FUEL BURNING FIREPLACES.**

	APPLIANCE INPUT RATE (Kbtu/Hr)										
	20	30	40	50	60	70	80	90	100	110	120
Chimney Height* (ft)	Minimum Openings** ( sq. in. )										
6	17.6	25.7	33.8	41.7	49.2	56.6	64.0	71.4	78.8	86.2	93.5
8	16.5	23.7	31.2	38.7	45.5	52.4	59.7	66.9	74.1	81.3	88.6
10	15.1	21.7	28.7	35.2	41.7	48.2	54.3	60.2	66.1	72.0	77.9
15	14.1	19.9	26.1	32.0	37.7	43.2	48.8	54.1	59.4	64.6	69.9
20	12.9	18.5	23.7	28.8	34.3	39.8	44.4	49.1	53.8	58.4	63.0
30	12.2	16.9	21.6	26.5	31.2	35.9	40.3	44.5	48.6	52.7	56.6

\*Height is from hearth to top of chimney and the minimum height is 6 feet.

\*\*Chart shows minimum opening (sq. in.) for a given height and input rate.

## IMPORTANT SAFEGUARDS

Although your gas logs are very realistic in appearance, it is not a real burning fireplace and must not be used for burning solid fuel.

To avoid irreparable damage to the heater or personal injury, matches, paper, garbage, or any other material **must not** be placed or thrown on top of the logs or into the flames.

To avoid personal injury, **do not touch hot surfaces** when the heater is operating. Close supervision is necessary when the heater is being operated near children.

**WARNING:** IN THE EVENT OF THE LOG BEING REMOVED, CARE SHOULD BE TAKEN TO NOT DAMAGE THE LOGS.

THE HEATER IS INTENDED FOR USE AS A GAS HEATER MOUNTED IN A VENTED OR VENT-FREE FIREPLACE AS DESCRIBED IN THESE INSTRUCTIONS. IT SHOULD NOT BE USED FOR ANY OTHER PURPOSE.

## CLEANING

**CAUTION** BEFORE CLEANING OR MOVING LOGS OR OTHER PARTS OF THE HEATER, BE SURE TO READ THE ABOVE SECTION ON “IMPORTANT SAFEGUARDS”.

All cleaning should be carried out when the heater is cold. Only limited cleaning will be required under normal use. Dusting the front of the base, the top of the piezo cover, or the control knob panel may be required occasionally. **Do not use any cleaning fluids to clean the logs or any other part of the heater.**

If the flames show any unusual shapes or behavior, or if the burners fail to ignite properly, then the burner holes may require cleaning. If this occurs, it is preferable to contact your nearest dealer to get your heater serviced.

Alternatively, the heater can be cleaned by removing the top, front, and rear logs. Handle the logs gently so as not to damage them. Always lift each log by holding it carefully at each end. Use a vacuum cleaner to carefully remove dust and loose particles from the base, logs, and from around the burners.

**WARNING:** Failure to keep the primary air openings(s) of the burner(s) clean may result in sooting and property damage.

## TROUBLESHOOTING

### WARNING

**TURN OFF, UNPLUG HEATER AND LET COOL BEFORE SERVICING.  
ONLY A QUALIFIED SERVICE PERSON SHOULD SERVICE AND  
REPAIR HEATER.**

### CAUTION

**NEVER USE A WIRE, NEEDLE, OR SIMILAR OBJECT TO CLEAN ODS/  
PILOT. THIS CAN DAMAGE ODS/PILOT.**

OBSERVED PROBLEM	POSSIBLE CAUSE	SOLUTION
When igniter button is pressed, there is no spark at ODS/PILOT	<ol style="list-style-type: none"> <li>1. Igniter electrode positioned incorrectly</li> <li>2. Igniter electrode broken</li> <li>3. Igniter electrode not connected to igniter cable</li> <li>4. Igniter cable pinched or wet</li> <li>5. Broken igniter cable</li> <li>6. Bad piezo igniter</li> </ol>	<ol style="list-style-type: none"> <li>1. Replace igniter</li> <li>2. Replace igniter</li> <li>3. Reconnect igniter cable</li> <li>4. Free igniter cable if pinched by any metal or tubing. Keep igniter cable dry.</li> <li>5. Replace piezo igniter cable.</li> <li>6. Replace igniter cable</li> </ol>

OBSERVED PROBLEM	POSSIBLE CAUSE	SOLUTION
When igniter button is pressed, there is spark at ODS/PILOT but no ignition.	<ol style="list-style-type: none"> <li>1. Gas supply turned off or manual shutoff valve is closed</li> <li>2. Control knob not in "PILOT" position</li> <li>3. Control knob not pressed in while in "PILOT" position</li> </ol>	<ol style="list-style-type: none"> <li>1. Turn on gas supply or open manual shutoff valve</li> <li>2. Turn control knob to "PILOT" position</li> <li>3. Press in control knob while in "PILOT" position.</li> </ol>

- |   |  |
|---|--|
| 4. Air in gas lines when installed      | 4. Continue to hold down control knob. Repeat igniting operation until air is removed. |
| 5. Depleted gas supply                  | 5. Contact local propane gas company   |
| 6. ODS/PILOT is clogged                 | 6. Clean ODS/PILOT or replace ODS/PILOT assembly                                       |
| 7. Gas regulator setting is not correct | 7. Replace gas regulator   |

<b>OBSERVED PROBLEM</b>	<b>POSSIBLE PROBLEM</b>	<b>SOLUTION</b>
ODS/PILOT lights but flame goes out when control knob is released	1. Control knob is not fully pressed in	1. Press in control knob completely
	2. Control knob not pressed in long enough	2. After ODS/PILOT lights keep control knob pressed in 30 seconds
	3. Safety interlock system has been triggered ( if equipped)	3. Wait 1 minute for safety interlock system to reset
	4. Manual shutoff valve not fully open	4. Fully open manual shutoff valve
	5. Thermocouple connection loose at control valve	5. Hand tighten until snug, then tighten 1/4 turn
	6. Pilot flame not touching thermocouple, which allows thermocouple to cool, causing pilot flame to go out. This problem can be caused by one or both of the following: A) low gas pressure B) dirty or partially clogged ODS/PILOT	6. A) Contact local propane gas company B) Clean ODS/PILOT (See Cleaning and Maintenance), or replace ODS/PILOT assembly
	7. Control valve damaged	7. Replace control valve

<b>OBSERVED PROBLEM</b>	<b>POSSIBLE CAUSE</b>	<b>SOLUTION</b>
Burner does not light after ODS/PILOT is lit.	<ol style="list-style-type: none"> <li>1. Burner orifice is clogged</li> <li>2. Inlet gas pressure is too low</li> </ol>	<ol style="list-style-type: none"> <li>1. Clean burner (see Cleaning and Maintenance) or replace burner orifice</li> <li>2. Contact your local propane company</li> </ol>
Delayed ignition of burner	<ol style="list-style-type: none"> <li>1. Manifold pressure is too low</li> <li>2. Burner orifice is clogged</li> </ol>	<ol style="list-style-type: none"> <li>1. Contact local propane company</li> <li>2. Clean burner (see Cleaning and Maintenance ) or replace burner orifice</li> </ol>
Burner backfiring during combustion	<ol style="list-style-type: none"> <li>1. Burner orifice is clogged or damaged</li> <li>2. Burner damaged</li> <li>3. Gas regulator defective</li> </ol>	<ol style="list-style-type: none"> <li>1. Clean burner (see Cleaning and Maintenance) or replace burner</li> <li>2. Replace burner</li> <li>3. Replace gas regulator</li> </ol>
Slight smoke or odor during initial operation	<ol style="list-style-type: none"> <li>1. Residues from manufacturing process</li> </ol>	<ol style="list-style-type: none"> <li>1. Problem will stop after a few hours of operation</li> </ol>
Heater produces a whistling noise when burner is lit	<ol style="list-style-type: none"> <li>1. Turning control knob to “HI” position when burner is cold (if equipped with this type of valve)</li> <li>2. Air in gas line</li> <li>3. Air passageways on heater blocked</li> <li>4. Dirty or partially clogged burner orifice</li> </ol>	<ol style="list-style-type: none"> <li>1. Turn control knob to “LOW” position and allow to warm for a minute</li> <li>2. Operate burner until air is removed from line. Call local propane company to check gas line.</li> <li>3. Observe minimum installation clearances</li> <li>4. Clean burner or replace orifice</li> </ol>

## WARNING

**IF YOU SMELL GAS:**

- \* **SHUT OFF GAS SUPPLY**
- \* **DO NOT TRY TO LIGHT APPLIANCE**
- \* **DO NOT TOUCH ANY ELECTRICAL SWITCH; DO NOT USE ANY PHONE IN YOUR BUILDING**
- \* **IMMEDIATELY CALL YOUR GAS SUPPLIER FROM A NEIGHBOR'S PHONE. FOLLOW THE GAS SUPPLIER'S INSTRUCTIONS.**
- \* **IF YOU CAN NOT REACH YOUR GAS SUPPLIER, CALL THE FIRE DEPARTMENT.**

**IMPORTANT:** Operating heater where impurities in the air exist may create odors. Cleaning supplies, paint, paint remover, cigarette smoke, cements and glues, new carpet or textiles , etc. create fumes. These fumes may mix with combustion air and create odors.

OBSERVED PROBLEM	POSSIBLE CAUSE	SOLUTION
Heater produces a clicking/ticking noise just after burner is lit or shut off	1. Metal expands while heating or contracts while cooling	1. This is common with most heaters. If noise is excessive, contact a qualified service person.
Heater produces unwanted odors	1. Heater burning vapors from paint, hair spray, glues, etc. (See "Important" above) 2. Low fuel supply 3. Gas leak (See WARNING above)	1. Ventilate room. Stop using odor causing products while heater is running. 2. Refill supply tank. 3. Locate and control all leaks. See "Checking Gas Connections".
Heater shuts off in use (ODS operates)	1. Not enough fresh air is available 2. Low line pressure 3. ODS/PILOT is partially clogged	1. Open window/door for ventilation 2. Contact local propane company 3. Clean ODS/PILOT
Gas odor even when control knob is in OFF position	1. Gas leak (see WARNING above) 2. Control valve defective	1. Locate and correct all leaks (see Checking Gas Connections) 2. Replace control valve



<b>OBSERVED PROBLEM</b>	<b>POSSIBLE CAUSE</b>	<b>SOLUTION</b>
Gas odor during combustion	1. Foreign matter between control valve and burner  2. Gas Leak. See WARNING statement at top of previous page	1. Take apart gas tubing and remove foreign matter  2. Locate and correct all leaks (see “Checking Gas Connections”)

---



---

**OPTIONAL PARTS NOT PROVIDED WITH CR8T LOG SET**

<b>PART#</b>	<b>DESCRIPTION</b>
MAPSFPC	CANOPY (HOOD)
MA19HS	19HS (HEAT SHIELD)

**NOTE:** CANOPY and 19HS are sold separately. They can be purchased from your local dealer or from the factory. Instructions for the Canopy and 19HS are provided when purchased.

# PARTS LIST

## Maxitrol Valve

KEY#	PART#	DESCRIPTION	QTY
1	PE GV30B5A2N7B	Maxitrol Nat. Valve	1
1A	PE GV30B5A2L7B	Maxitrol LP Valve	1
2	PH 4966	3/8" - 3/8" Elbow	1
3	PO TBURN	Single Burner	1
4	PE TPT100/433	Thermocouple (Copreci)	1
5	PE 2150053	Copreci ODS Nat. Pilot	1
5A	PE 2150054	Copreci ODS LP Pilot	1
6	PE RV12LF30	Pilot Regulator—Nat.	1
6A	PE RV12LF90	Pilot Regulator—LP	1
7	RF 14ALMTUB	1/4" Aluminum Tubing	1
8	PH 1166	3/8" Street Elbow	1
9	PH 6842	1/4" - 1/8" Compression Adapter	1
10	PO 42ORF	Nat. Orifice	1
10A	PO 54ORF	LP. Orifice	1
11	PO 389ALMTUB	3/8" x 9" Aluminum Supply Tube	1
12	PO 54ORFHLD	Angled Orifice Holder	1
13	PO 38312BINIP	3/8" x 3-1/2" Black Pipe	1

*Note: Refer To Figure 9 On Page 32.*

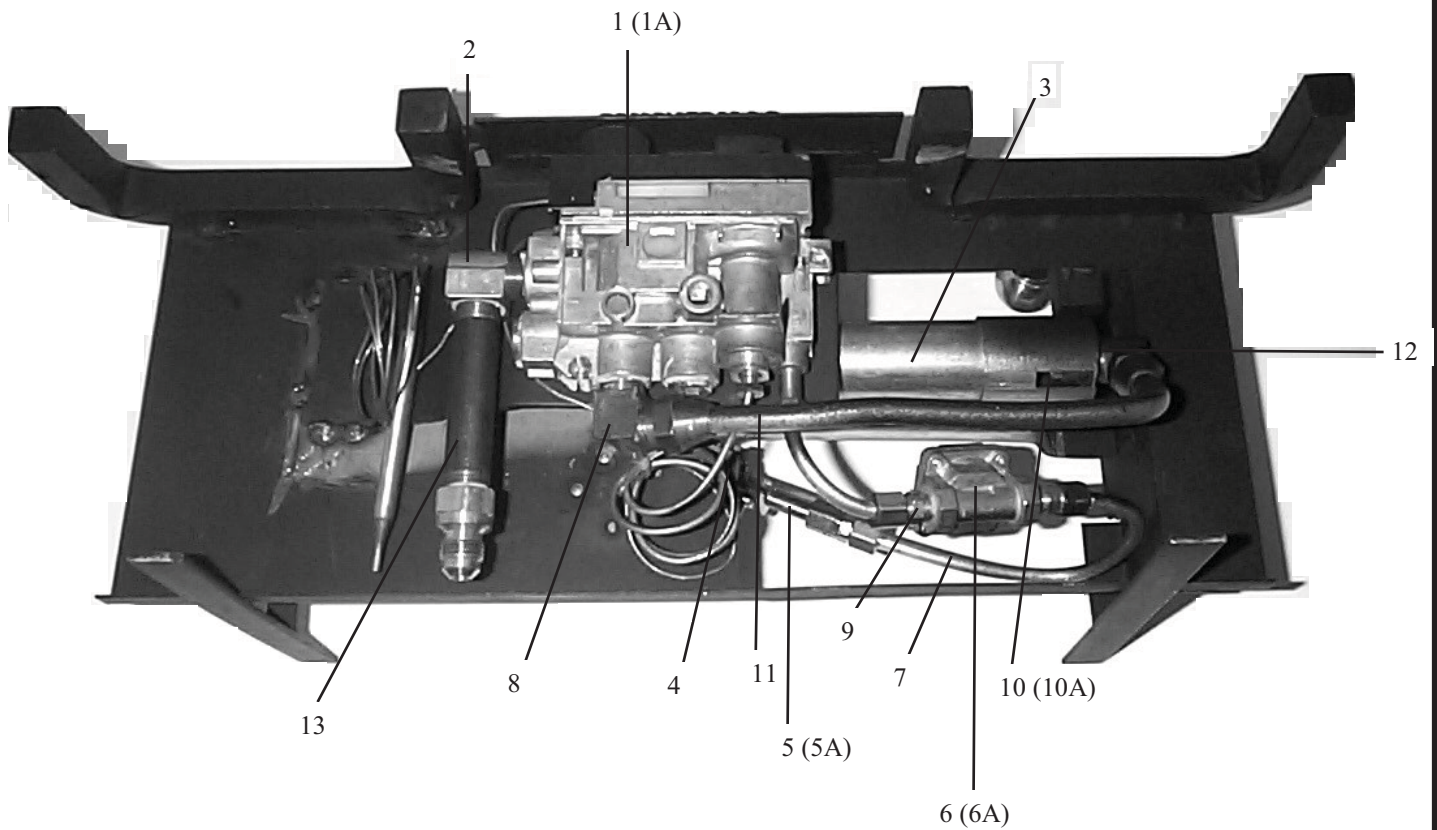

**FIGURE 9**

## BASE IDENTIFICATION

- (1) Brass Knobs
- (2) Right Burner Support
- (3) Air Adjustment Shutter
- (4) Access Door
- (5) Front Log Support
- (6) Rear Log Holder
- (7) Igniter Control And Pilot Control
- (8) Flame Adjustment Control
- (9) Mertik Valve
- (10) Left Burner Support
- (11) Burner
- (12) Buck Stove Logo

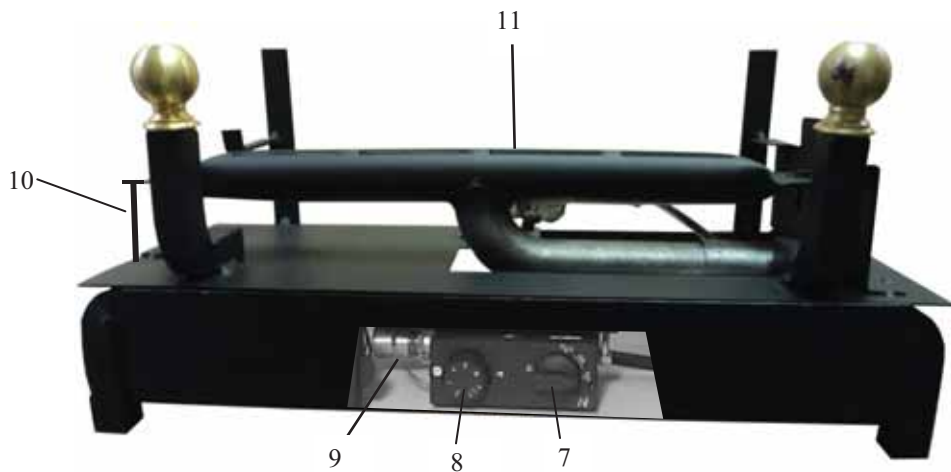

**NEW BUCK CORPORATION  
PO BOX 69  
SPRUCE PINE, NC 28777**

We reserve the right to amend these specifications at any time without notice. The only warranty applicable is our standard written warranty. We make no other warranty, expressed or implied.

**LIMITED WARRANTY  
VENT-FREE AND VENTED GAS LOGS**

New Buck warrants this product to be free from defects in materials and components for two (2) years from the date of first purchase, provided that the product has been properly installed, operated and maintained in accordance with all applicable instructions. To make a claim under this warranty the Bill of Sale or canceled check must be presented.

This warranty is extended only to the original retail purchaser. This warranty covers only the cost of part (s) required to restore this heater to proper condition. Warranty part (s) MUST be obtained through authorized dealers of this product and/or NEW BUCK who will provide original factory replacement parts . Failure to use original factory replacement parts voids this warranty. The heater MUST be installed by a qualified installer in accordance with all local codes and instructions furnished with the unit.

This warranty does not apply to parts that are not in original condition, because of normal wear and tear, or parts that fail or become damaged as a result of misuse, accidents, lack of proper maintenance or defects caused by improper installation.

What is not covered:

- \*Removal and re-installation costs.
- \*Labor costs for replacement or repairs.
- \*Transportation or labor costs.
- \*The cost of a service call to diagnose trouble.
- \*Painted surfaces.
- \*Damage or defect caused by improper installation, accident, misuse, abuse, or alteration.

TO THE FULL EXTENT ALLOWED BY THE LAW OF THE JURISDICTION THAT GOVERNS THE SALE OF THE PRODUCT, THIS EXPRESS WARRANTY EXCLUDES ANY AND ALL OTHER EXPRESSED WARRANTIES AND LIMITS THE DURATION OF ANY AND ALL IMPLIED WARRANTIES, INCLUDING WARRANTIES OF MERCHANTABILITY AND FITNESS FOR A PARTICULAR PURPOSE TO ONE (1) YEAR FROM THE DATE OF FIRST PURCHASE, NEW BUCK LIABILITY IS HERBY LIMITED TO THE PURCHASE PRICE OF THE PRODUCT AND NEW BUCK SHALL NOT BE LIABLE FOR ANY OTHER DAMAGES WHATSOEVER INCLUDING INDIRECT, INCIDENTAL OR CONSEQUENTIAL DAMAGES.

Some states do not allow a limitation on how long an implied warranty lasts or an exclusion or limitation of incidental or consequential damages, so the previous limitation on implied warranties, or exclusion or limitation on damages may not apply to you.

This warranty gives you specific legal rights, and you may also have other rights that vary from state to state.

## OWNER REGISTRATION CARD

The attached owner registration card must be completed in its entirety and mailed within 30 days from the date of installation in order for warranty coverage to begin to:

New Buck Corporation  
P.O. Box 69  
Spruce Pine, NC 28777  
Email: info@buckstove.com

PLEASE NOTE: The Owner Registration Card must contain the Authorized Buck Stove Dealer Number and the Certified Installer's number (if applicable) for warranty coverage to begin.

NAME \_\_\_\_\_

ADDRESS \_\_\_\_\_

CITY \_\_\_\_\_ STATE \_\_\_\_\_ ZIP \_\_\_\_\_

CUSTOMER EMAIL \_\_\_\_\_

MODEL # \_\_\_\_\_

SERIAL # \_\_\_\_\_ DATE OF INSTALLATION \_\_\_\_\_

INSTALLER'S NAME \_\_\_\_\_

DEALER NAME \_\_\_\_\_