

ZECL-30-3226 Electric Fireplace with log set
and optional ZECL-30 mantle in Espresso



ZERO CLEARANCE & INSERTS

LED LIGHT - HEATER WITH FAN

Amantii

ZERO-CLEARANCE SERIES



ZECL-26-2923 Electric Fireplace with Harvest Moon fire glass

ZECL-26-2923 SPECIFICATIONS

ZERO CLEARANCE SERIES Fireplace Features

- Clean black glass face
- No grills
- Three stage heater
- 4-stage front and 4-stage back light
- Featuring the latest LED light technology with multi colour
- Heat can operate without flame
- Approx. heating area – 400-500 sq. ft.
- Flame operates with or without heat
- Remote control for flame and heater included
- Front and rear control for lighting effects
- Plug located on the left side
- Three colours of fire glass media & log all included in the box



Enduring Style.

By design the ZECL-26-2923 is an excellent choice for new construction or renovation projects. Simple and quick to install, this aesthetically pleasing unit features a black glass surround that easily compliments any decor. Comes with three colours of fire glass media & log set.

Volts	120
Amps	12.5
Watts	1500 max
Heater	1500 watts high, 750 watts low
No Heater	22 watts
Lamps	LED 22 watts
Rotor Motor	1 at 5 watts
Height, Width, Depth	22 1/2 x 25 1/2 x 8 1/2
Glass Viewing Opening	21 x 11 3/8
Glass Size	29 1/4 x 23
Shipping Size	25 1/4 x 32 3/4 x 12 1/4
Shipping Weight	55 lbs. Glass Included
Cord Length	76"

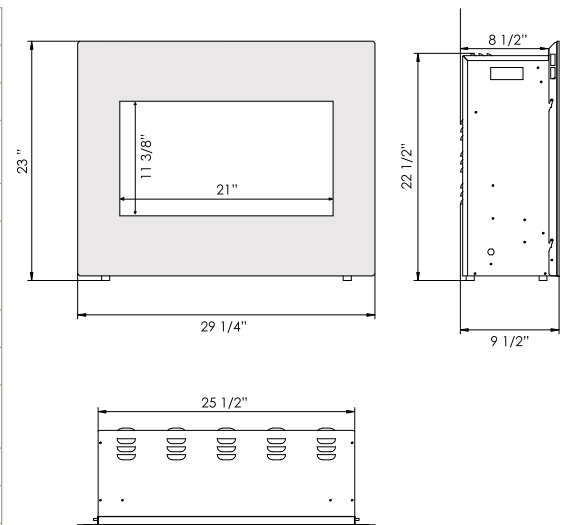

work of art



ZECL-30-3226 Electric Fireplace with log set in a ZECL-30 Simply White Mantle

ZECL-30-3226 SPECIFICATIONS



Hot & Fashionable.

Designed for new construction or renovation projects, the electric ZECL-30-3226 is an excellent alternative to gas or wood fireplaces. Quick and easy installation allows for immediate enjoyment of the state-of-the-art flame and heating system. Comes with three colours of fire glass media & log set.

The ZECL-30-3226 also fits into our optional ZECL-30 Mantel (see page 4.)

Volts	120
Amps	12.5
Watts	1500 max
Heater	1500 watts high, 750 watts low
No Heater	22 watts
Lamps	LED 22 watts
Rotor Motor	1 at 5 watts
Height, Width, Depth	24 3/4 x 29 1/2 x 8 1/2
Glass Viewing Opening	24 5/8 x 13
Glass Size	32 1/2 x 25 5/8
Shipping Size	27 3/4 x 35 1/4 x 12 1/4
Shipping Weight	64 lbs. Glass Included
Cord Length	76"

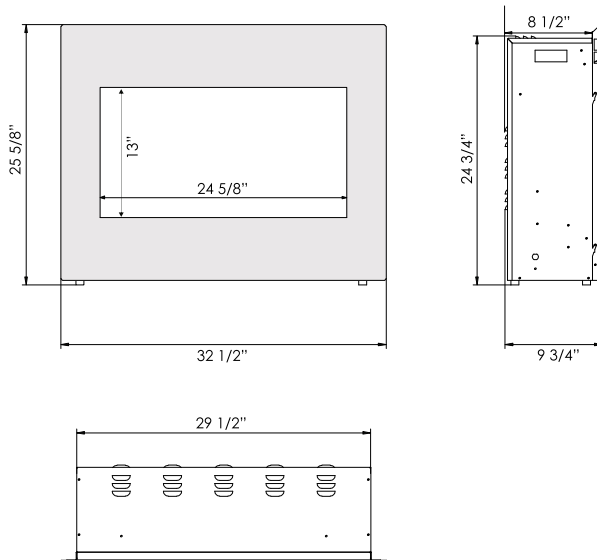

ZECL-30 MANTLE



Quality Craftsmanship.

The ZECL-30 mantle is beautifully hand crafted from maple hardwood and is the perfect mantle to house the ZECL-30-3226. The mantle is available unfinished and ready to take on any colour you choose, as well as in two stained finishes - Simply White and Espresso. It is easy to assemble and available only for the ZECL-30-3226. Cabinet (left) shown in Espresso. Unassembled pieces below.

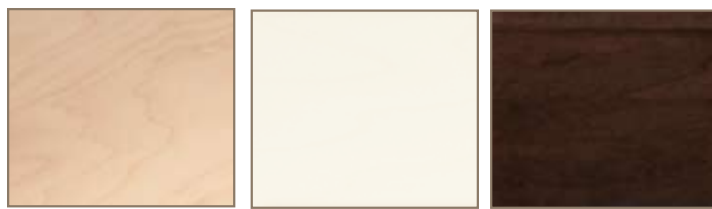

Natural Grain
(unfinished)

Simply White

Espresso

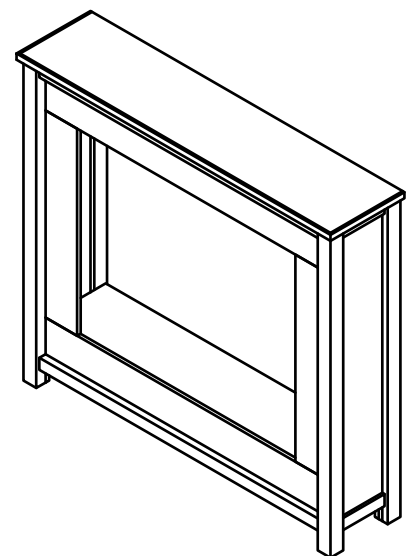
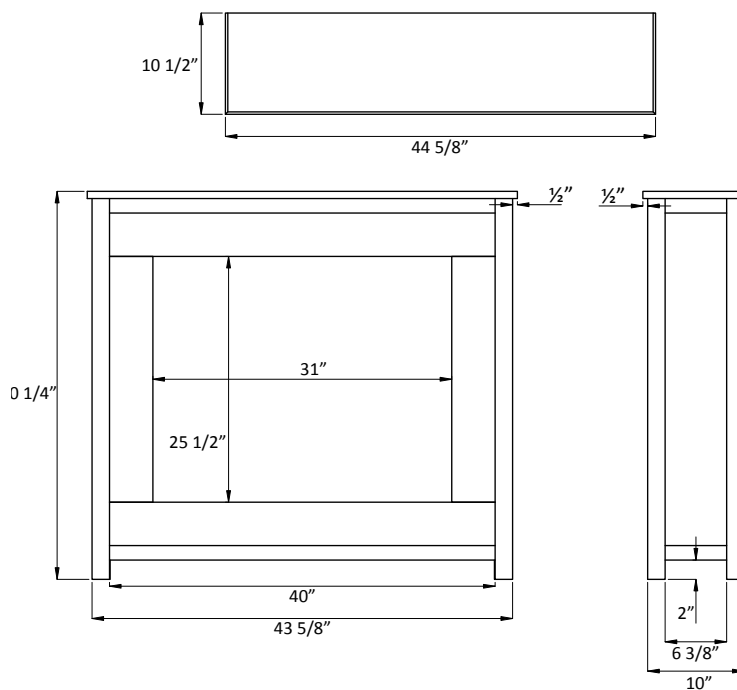

versatile



ZECL-33-3624 Electric Fireplace with optional Blaze fire glass

ZECL-33-3624 SPECIFICATIONS

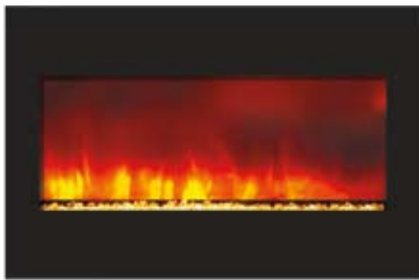

Clean & Distinct.

An excellent alternative to gas or wood fireplaces, the electric ZECL-33-3624 is designed for new construction or renovation projects. Enjoy the state-of-the-art flame and heating system faster thanks to a quick and easy installation. Comes with three colours of fire glass media & log set.

Volts	120
Amps	12.5
Watts	1500 max
Heater	1500 watts high, 750 watts low
No Heater	22 watts
Lamps	LED 22 watts
Rotor Motor	1 at 5 watts
Height, Width, Depth	22 1/4 x 30 3/4 x 8 1/2
Glass Viewing Opening	30 x 11 1/2
Glass Size	36 x 24
Shipping Size	26 x 38 1/4 x 12 1/4
Shipping Weight	66 lbs. Glass Included
Cord Length	76"

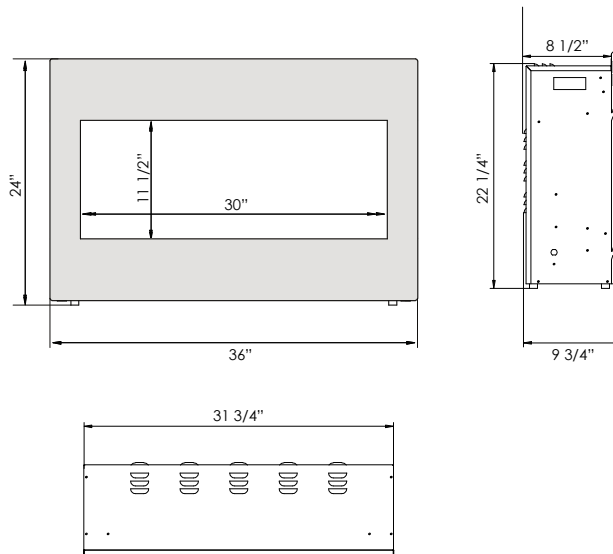



ZECL-39-4134 Electric Fireplace with optional Sable fire glass

ZECL-39-4134 SPECIFICATIONS



Striking & Bold.

This bold unit is both eye catching and practical. The ZECL-39-4134 is designed for easy, fast installation and is perfect for new construction builds or renovations. Features a black glass surround and comes with three colours of fire glass media & log set.

Volts	120
Amps	12.5
Watts	1500 max
Heater	1500 watts high, 750 watts low
No Heater	22 watts
Lamps	LED 22 watts
Rotor Motor	1 at 5 watts
Height, Width, Depth	32 x 37 1/2 x 8 1/2
Glass Viewing Opening	30 7/8 x 20 3/8
Glass Size	41 x 34 1/2
Shipping Size	36 3/8 x 44 1/8 x 12 1/4
Shipping Weight	86 lbs. Glass Included
Cord Length	76"

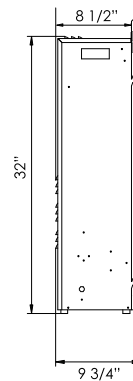
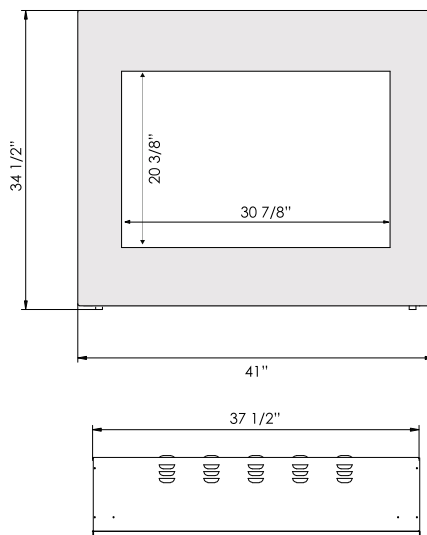



ZECL-2939 Electric
Fireplace with log set

ZECL-2939 SPECIFICATIONS



Versatile & Cozy.

The ZECL-2939 electric fireplace is a stylish, vertical option. It gives you the benefit of fitting easily into a small room and adding warmth to any space in your home. Comes with three colours of fire glass media & log set. Ideal for new construction or renovations.

Volts	120
Amps	12.5
Watts	1500 max
Heater	1500 watts high, 750 watts low
No Heater	22 watts
Lamps	LED 22 watts
Rotor Motor	1 at 5 watts
Height, Width, Depth	37 3/4 x 24 1/4 x 8 1/2
Glass Viewing Opening	21 1/2 x 26 3/4
Glass Size	29 1/2 x 39 1/4
Shipping Size	41 x 32 1/2 x 12 1/4
Shipping Weight	66 lbs. Glass Included
Cord Length	76"

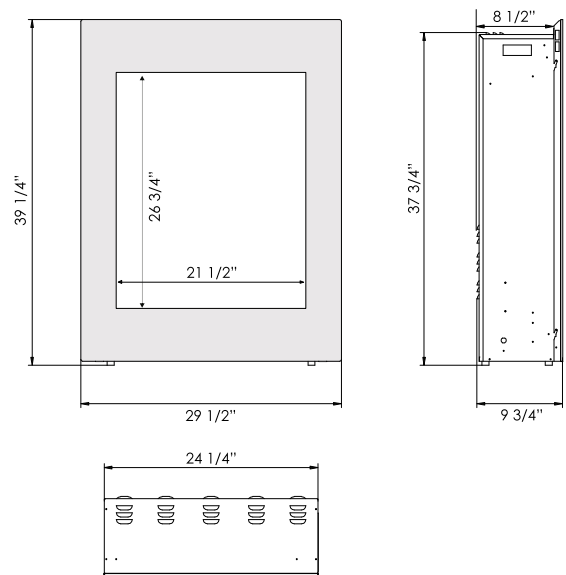

ACCESSORIES & FIRE GLASS OPTIONS



ZECL-39-4134 Electric Fireplace with Clear fire glass

LOG SET

The logs come with both the WM/BI Series, ZECL Series, INSERT Series and the WM-50.



Variations in colour and shade are inherent in all printing processes, the actual colours may vary slightly from those shown in this brochure. Please visit your local dealer to view a sample.

FIRE GLASS COLOURS

The three fire glass colours below are included with the WM/BI Series, ZECL Series, BLT-IN Series, WM-50 and WM-3522CF



Hz-01 Clear



Hz-04 Harvest Moon



Hz-09 Sun Tea

OPTIONAL FIRE GLASS

The three optional fire glass colours below are available to purchase at an additional charge.



Hz-05 Goldenrod



Hz-06 Blaze



Hz-07 Sunset



Hz-08 Sable

INSERT SERIES



Small INSERT-26-3825 Electric Fireplace with optional Goldenrod fire glass

INSERT-26-3825 SPECIFICATIONS

INSERT SERIES Fireplace Features

- Clean black glass face
- No grills
- Three stage heater
- 4 stage front and 4 stage back light
- 4 leveling legs on the underside
- Featuring the latest LED light technology with multi colour
- Heat can operate without flame
- Approx. heating area – 400-500 sq. ft.
- Flame operates with or without heat
- Remote control for flame and heater included
- Front and rear control for lighting effects
- Plug located on the left side
- Cord length - 76"
- Three colours of fire glass media & log set

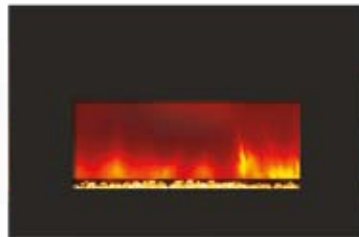

Ideal for Home Improvements

Designed as an alternative for wood or gas inserts the INSERT-26-3825 is modern and sophisticated. This unit is quick and easy to install making it an ideal application if you are renovating an existing fireplace. Comes with three colours of fire glass media & log set.

Volts	120
Amps	12.5
Watts	1500 max
Heater	1500 watts high, 750 watts low
No Heater	22 watts
Lamps	LED 22 watts
Rotor Motor	1@5 watts
Height, Width, Depth	16 3/4 x 25 1/4 x 8 1/2
Glass Viewing Opening	23 3/4 x 9 1/2
Glass Size	38 x 25
Shipping Size	27 1/4 x 41 3/8 x 12 1/4
Shipping Weight	62 lbs. Glass Included

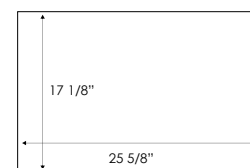
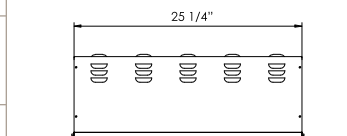
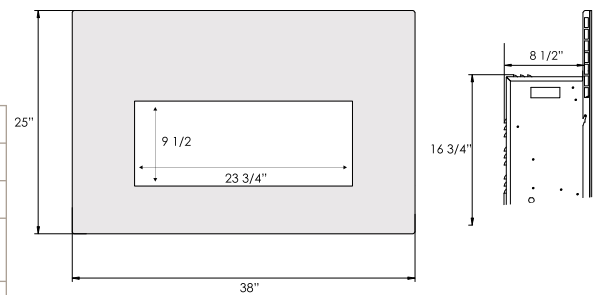

Minimum opening size required 17 1/8" H x 25 5/8" W

INSERT-26-3825
winner of a Vesta Award
in Electric Products.

The Vesta Awards recognize
specific products for innovation
in design and/or technology.





Medium INSERT-30-4230 Electric Fireplace with a mix of Clear and Harvest Moon fire glass

INSERT-30-4026 SPECIFICATIONS

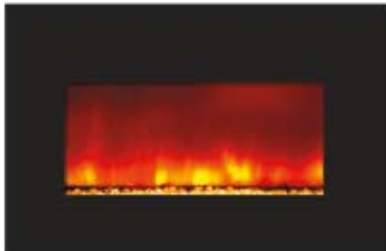

Practical & Efficient.

Breathe new life into existing masonry or metal fireplaces with the stylish electric Insert-30-4026. Designed as an alternative to wood or gas units the Insert-30-4026 is modern and sophisticated. This medium sized unit is ideal for renovations and is quick and easy to install. Comes with three colours of fire glass media & log set.

Volts	120
Amps	12.5
Watts	1500 max
Heater	1500 watts high, 750 watts low
No Heater	22 watts
Lamps	LED 22 watts
Rotor Motor	1@5 watts
Height, Width, Depth	19 1/4 x 29 1/2 x 8 1/2
Glass Viewing Opening	26 3/4 x 11 1/2
Glass Size	40 x 26
Shipping Size	32 3/8 x 44 3/4 x 12 1/4
Shipping Weight	73 lbs. Glass Included

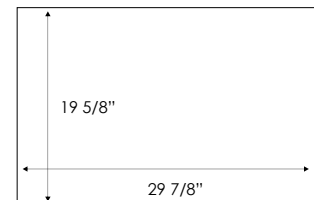
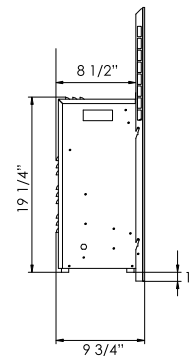
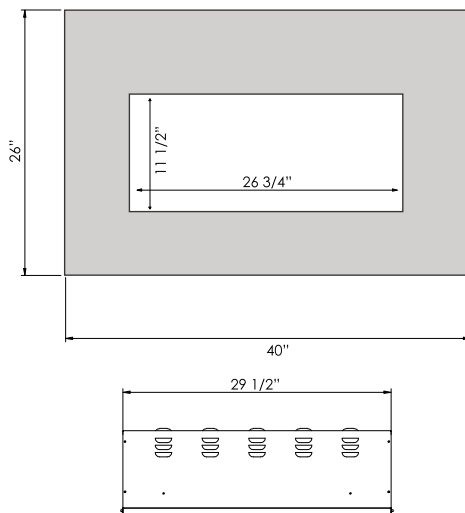

Minimum opening size required 19 5/8" H x 29 7/8" W



Large INSERT-33-4230
Electric Fireplace with log set

make an impact

INSERT-33-4230 SPECIFICATIONS



Charming & Resourceful.

A perfect alternative for wood or gas inserts, the electric Insert-33-4230 is stylish and practical. This large sized unit is quick and easy to install making it an ideal application if you are renovating an existing fireplace. Comes with three colours of fire glass media & log set.

Volts	120
Amps	12.5
Watts	1500 max
Heater	1500 watts high, 750 watts low
No Heater	22 watts
Lamps	LED 22 watts
Rotor Motor	1@5 watts
Height, Width, Depth	22 1/4 x 31 3/4 x 8 1/2
Glass Viewing Opening	29 3/4 x 11 3/4
Glass Size	42 x 30
Shipping Size	32 3/8 x 45 1/8 x 12 1/4
Shipping Weight	80 lbs. Glass Included

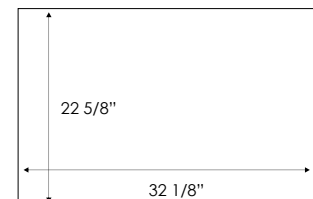
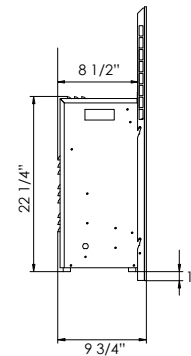
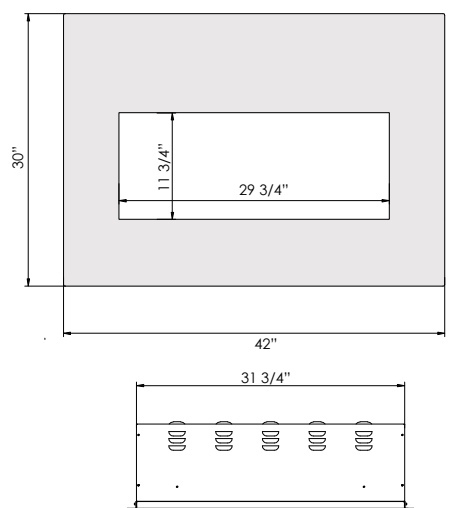

Minimum opening size required 22 5/8" H x 32 1/8" W

PRICE LIST

Part Number	Description	MSRP
-------------	-------------	------

ZERO CLEARANCE

ZECL-26-2923	26" Zero Clearance Unit with 29" x 23" Black Glass Surround
ZECL-30-3226	30" Zero Clearance Unit with 32" x 26" Black Glass Surround
ZECL-30-3226-MANT-NATURALGRAIN	30" Unit with Natural Grain (Unfinished) Mantle
ZECL-30-3226-MANT-ESPRESSO	30" Unit with Espresso stained Mantle
ZECL-30-3226-MANT-SIMPLYWHITE	30" Unit with White stained Mantle
ZECL-33-3624	33" Zero Clearance Unit with 36" x 24" Black Glass Surround
ZECL-39-4134	39" Zero Clearance Unit with 41" x 34" Black Glass Surround
ZECL-2939	Zero Clearance Electric Fireplace

INSERTS

INSERT-26-3825	Small Insert Electric Fireplace
INSERT-30-4026	Medium Insert Electric Fireplace
INSERT-33-4230	Large Insert Electric Fireplace

Amantii

Phone: 888.406.8764
Fax: 877.498.4206
Web site: www.amantii.com



Distributed By:



Intertek