

Amantii

ELECTRIC FIREPLACES

INSTALLATION /OWNER'S MANUAL WALL-MOUNT & BUILT-IN UNIT



WM-FM-26-3623-BG
(WM-G190026-1)

WM-FM-48-5823-BG
(WM-G190048-1)

WM-FM-72-8123-BG
(WM-G190072-1)

WM-FM-34-4423-BG
(WM-G190034-1)

WM-FM-60-7023-BG
(WM-G190060-1)

WM-FM-88-10023-BG
(WM-G190088-1)

SAFETY INFORMATION



WARNING

For your safety, always comply with all warnings and safety instructions contained in this manual to prevent personal injury or property damage.

Do not store or use gasoline or other flammable vapors and liquids in the vicinity of this appliance.

**INSTALLER: LEAVE OWNER'S MANUAL WITH THE APPLIANCE.
CONSUMER: RETAIN OWNER'S MANUAL FOR FUTURE REFERENCE.**



WARNING: This product can expose you to chemicals including Lead in the wiring, which is [are] known to the State of California to cause birth defects or other reproductive harm. For more information visit: www.p65warnings.ca.gov



TABLE OF CONTENTS

Please read and carefully follow all of the instruction found in this manual. The instructions included here will assure that you have many years of dependable and enjoyable service from your Amantii product.

IMPORTANT INSTRUCTIONS.....	3
FCC CAUTIONS	4
UNPACKING AND TESTING THE APPLIANCE	5
GROUNDING APPLIANCE	5
LOCATING THE FIREPLACE.....	5
WM-FM-26-3623-BG (WM-G190026-1)	6
WM-FM-34-4423-BG (WM-G190034-1)	7
WM-FM-48-5823-BG (WM-G190048-1)	8
WM-FM-60-7023-BG (WM-G190060-1)	9
WM-FM-72-8123-BG (WM-G190072-1)	10
WM-FM-88-10023-BG (WM-G190088-1)	11
REMOVING FRONT GLASS.....	12
INSTALLATION WALL-MOUNT	13
INSTALLATION BUILT-IN.....	14
MANTEL CLEARANCE.....	15
HARDWIRE INSTALLATION	15
MEDIA OPTIONS	16
DECORATIVE MEDIA INSTALLATION.....	16
OPERATION.....	17
MANUAL OPERATION	17
REMOTE CONTROL OPERATION.....	18
WIFI OPERATION.....	21
REPLACEMENT PARTS.....	24
EXPLODED VIEW	26
TROUBLE SHOOTING.....	27
SERVICE HISTORY	28
WARRANTY	29

IMPORTANT INSTRUCTIONS

PLEASE RETAIN THIS USER GUIDE FOR FUTURE REFERENCE

When using electrical appliances, basic precautions should always be followed to reduce the risk of fire, electric shock, and injury to persons, including the following:

- 1) Read all instructions before using this fireplace
- 2) The fireplace is hot when in use. To avoid burns, do not let bare skin touch hot surfaces. Keep combustible material such as furniture, cushions, bedding, paper, clothes, curtains at least 3 feet from the front of the unit
- 3) Extreme caution is necessary when any heater is used near children and whenever the unit is left operating and unattended.
- 4) Do not operate a fireplace with a damaged cord or plug, or if the heater has malfunctioned, the fireplace has drooped or damaged in any manner
- 5) Not all fireplaces are suitable for use in bathrooms or laundry facilities. Please consult with individual product literature to confirm suitability
- 6) Do not run the cord under carpeting. Do not cover cord with throw rugs, runners or the like. Arrange the cord away from traffic area and where it will not be tripped over
- 7) Do not modify this fireplace. Use it as described in the manual. Any other use not recommended by the manufacture may cause fire, shock or injury to persons
- 8) Do not use this heater with programmer, timer, separate remote-control system or any other device that switches the heater on automatically, since a fire risk exists if the heater is covered or positioned incorrectly
- 9) Disconnect all power supply before cleaning, maintenance or relocation of the fireplace
- 10) Keep the heater clean. Do not allow any objects to enter any ventilation or exhaust opening as this may cause electric shock, fire or damage to the heater
- 11) Do not immerse the cord, plug or any part of the appliance in water or any other liquid
- 12) In order to avoid a hazard due to inadvertent resetting of the thermal cut-out, this appliance must not be supplied through an external switching device

SAVE THESE INSTRUCTIONS

CAUTION: Procedures and techniques, which, if not carefully followed, will result in damage to the equipment.

WARNING: Procedures and techniques, which, if not carefully followed, will expose the user to the risk of fire, serious injury, illness or death.

Consult with professional electrician and adhere to all code requirements for installations in bathrooms

FCC CAUTIONS

This device complies with part 15 of the FCC Rules. Operation is subject to the following two conditions: (1) This device may not cause harmful interference, and (2) this device must accept any interference received, including interference that may cause undesired operation.

Any Changes or modifications not expressly approved by the party responsible for compliance could void the user's authority to operate the equipment.

Note: This equipment has been tested and found to comply with the limits for a Class B digital device, pursuant to part 15 of the FCC Rules. These limits are designed to provide reasonable protection against harmful interference in a residential installation. This equipment generates uses and can radiate radio frequency energy and, if not installed and used in accordance with the instructions, may cause harmful interference to radio communications. However, there is no guarantee that interference will not occur in a particular installation. If this equipment does cause harmful interference to radio or television reception, which can be determined by turning the equipment off and on, the user is encouraged to try to correct the interference by one or more of the following measures:

Reorient or relocate the receiving antenna.

Increase the separation between the equipment and receiver.

Connect the equipment into an outlet on a circuit different from that to which the receiver is connected.

Consult the dealer or an experienced radio/TV technician for help.

This equipment complies with FCC radiation exposure limits set forth for an uncontrolled environment. This equipment should be installed and operated with minimum distance 20cm between the radiator & your body.

UNPACKING AND TESTING APPLIANCE

Carefully remove the appliance from the box. Prior to installing the appliance, test to make sure the appliance operates properly by plugging the power supply cord into a conveniently located 120 Volt grounded outlet.

There are two screws on each side to fix the front glass.

Please see the figure right side.

TAKE OUT THIS SCREW ON EACH SIDE
before you take off the front glass.

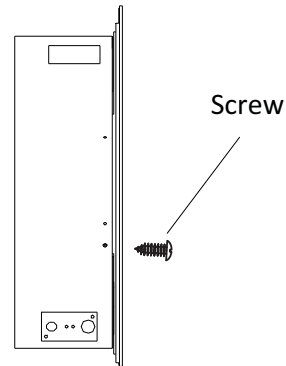

NOTE: There may be trace of odor during the first few minutes of initial use. This is harmless, normal and will never occur again.

GROUNDING APPLIANCE

This appliance is for use on 120 Volts. The cord has a plug as shown in (A). An adapter as shown in (C) is available for connecting three-blade grounding type plugs to two-slot receptacles. The green grounding lug extending from the adapter must be connected to a permanent ground such as a properly grounded outlet box. The adapter should not be used if a three-slot grounded receptacle is available.

To disconnect appliance, turn controls to off, then remove plug from outlet.

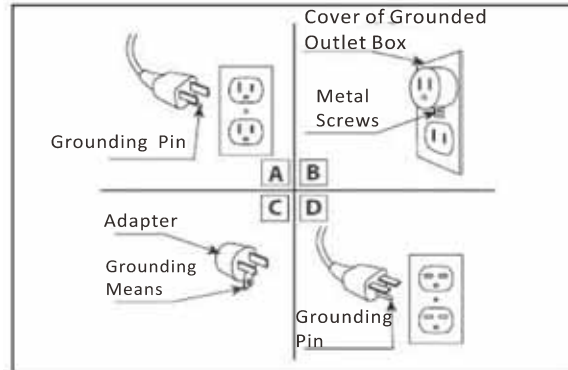

Note : Adaptor are NOT for use in Canada

LOCATING THE FIREPLACE

Plan where to locate and frame the fireplace. This will save time and money later when you install the fireplace. Before installation consider the following:

1. Where the fireplace is located must allow for wall and ceiling clearances (see **INSTALLATION-WALL MOUNT**)
2. Consider a location where the fireplace screen will not be exposed to direct sunlight from windows or doors.
3. A 15 ampere, 120 Volt, 60 Hz branch circuit with proper ground must be available at the location. Preferably a dedicated branch circuit should be provided to avoid circuit breakers to trip of fuses to blow.

WM-FM-26-3623-BG (WM-G190026-1)

Description	Built-in or Wall Mount Appliance
Voltage	120V AC 60Hz
Watts	1500W Max
NO HEATER	25W
MOTOR HEATER	19W
Appliance Width	25 1/2" or 64.9 cm
Appliance Height	19 7/8" or 50.6 cm
Appliance Depth	6 1/8" or 15.5 cm
Gross Weight	52.8 lbs or 24 kg
Plug Location	Left side
Cord Length	70 7/8" or 180 cm
Rough Wall Opening Size	27" × 20 1/2" or 68.60 cm × 52 cm
BTU	5118

This appliance has been tested in accordance with the UL Standard 2021 for fixed and location dedicated electric room appliances in the United States and Canada. If you need assistance during installation, please contact your local dealer.

NOTE: This appliance must be electrically wired and grounded in accordance with local codes. In the absence of local codes, use the current CSA C22.1 Canadian Electrical Code in Canada or the ANSI/NFPA 70 National Electrical Code in the United States.

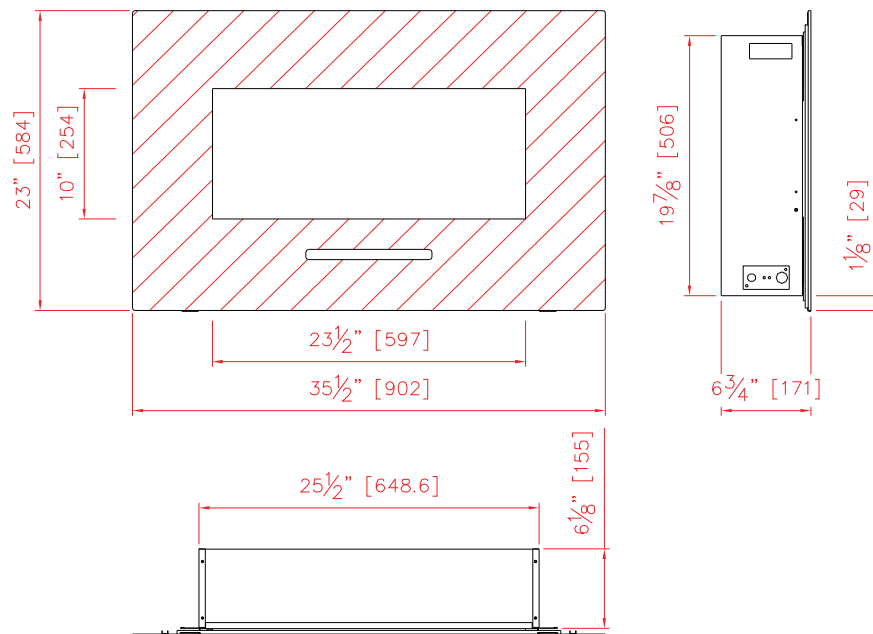

WM-FM-34-4423-BG (WM-G190034-1)

Description	Built-in or Wall Mount Appliance
Voltage	120V AC 60Hz
Watts	1500W Max
NO HEATER	25W
MOTOR HEATER	19W
Appliance Width	33 1/2" or 85.2 cm
Appliance Height	19 7/8" or 50.6 cm
Appliance Depth	6 1/8" or 15.5 cm
Gross Weight	63.1 lbs or 28.7 kg
Plug Location	Left side
Cord Length	70 7/8" or 180 cm
Rough Wall Opening Size	35" × 20 1/2" or 88.9 cm × 52 cm
BTU	5118

This appliance has been tested in accordance with the UL Standard 2021 for fixed and location dedicated electric room appliances in the United States and Canada. If you need assistance during installation, please contact your local dealer.

NOTE: This appliance must be electrically wired and grounded in accordance with local codes. In the absence of local codes, use the current CSA C22.1 Canadian Electrical Code in Canada or the ANSI/NFPA 70 National Electrical Code in the United States.

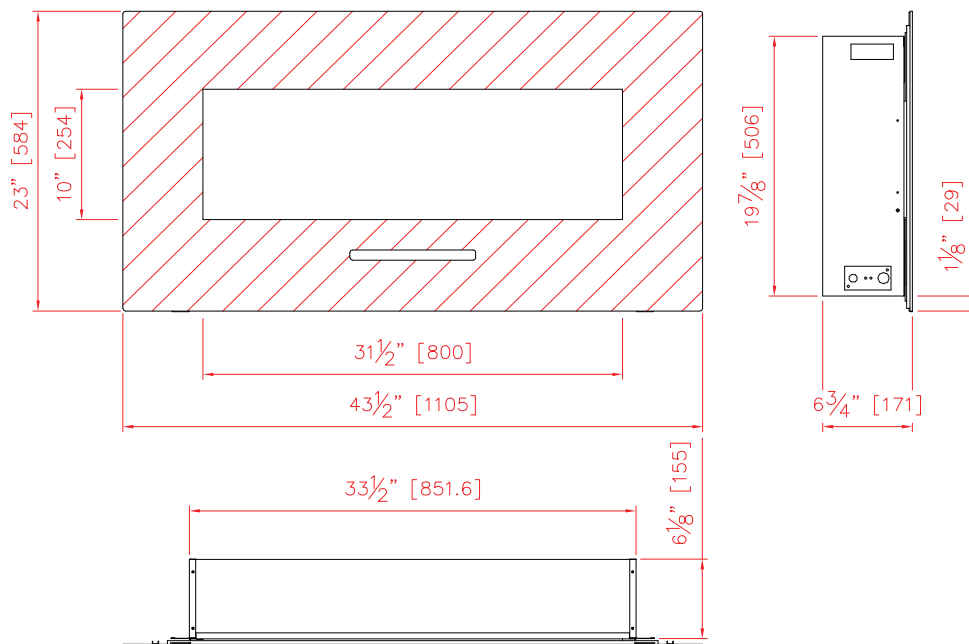

WM-FM-48-5823-BG (WM-G190048-1)

Description	Built-in or Wall Mount Appliance
Voltage	120V AC 60Hz
Watts	1500W Max
NO HEATER	25W
MOTOR HEATER	19W
Appliance Width	47 1/2" or 120.6 cm
Appliance Height	19 7/8" or 50.6 cm
Appliance Depth	6 1/8" or 15.5 cm
Gross Weight	81 lbs or 36.7 kg
Plug Location	Left side
Cord Length	70 7/8" or 180 cm
Rough Wall Opening Size	49" × 20 1/2" or 124.5 cm × 52 cm
BTU	5118

This appliance has been tested in accordance with the UL Standard 2021 for fixed and location dedicated electric room appliances in the United States and Canada. If you need assistance during installation, please contact your local dealer.

NOTE: This appliance must be electrically wired and grounded in accordance with local codes. In the absence of local codes, use the current CSA C22.1 Canadian Electrical Code in Canada or the ANSI/NFPA 70 National Electrical Code in the United States.

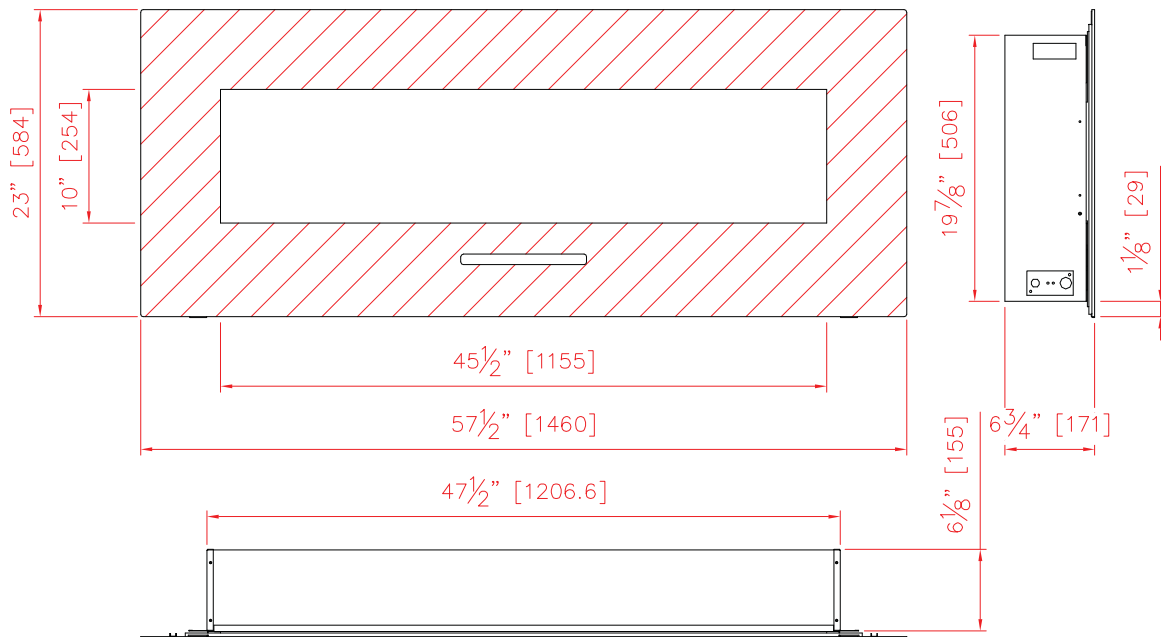

WM-FM-60-7023-BG (WM-G190060-1)

Description	Built-in or Wall Mount Appliance
Voltage	120V AC 60Hz
Watts	1500W Max
NO HEATER	25W
MOTOR HEATER	19W
Appliance Width	59 1/4" or 150.6 cm
Appliance Height	19 7/8" or 50.6 cm
Appliance Depth	6 1/8" or 15.5 cm
Gross Weight	97.2lbs or 44.2kg
Plug Location	Left side
Cord Length	70 7/8" or 180 cm
Rough Wall Opening Size	60 5/8" × 20 1/2" or 154 cm × 52cm
BTU	5118

This appliance has been tested in accordance with the UL Standard 2021 for fixed and location dedicated electric room appliances in the United States and Canada. If you need assistance during installation, please contact your local dealer.

NOTE: This appliance must be electrically wired and grounded in accordance with local codes. In the absence of local codes, use the current CSA C22.1 Canadian Electrical Code in Canada or the ANSI/NFPA 70 National Electrical Code in the United States.

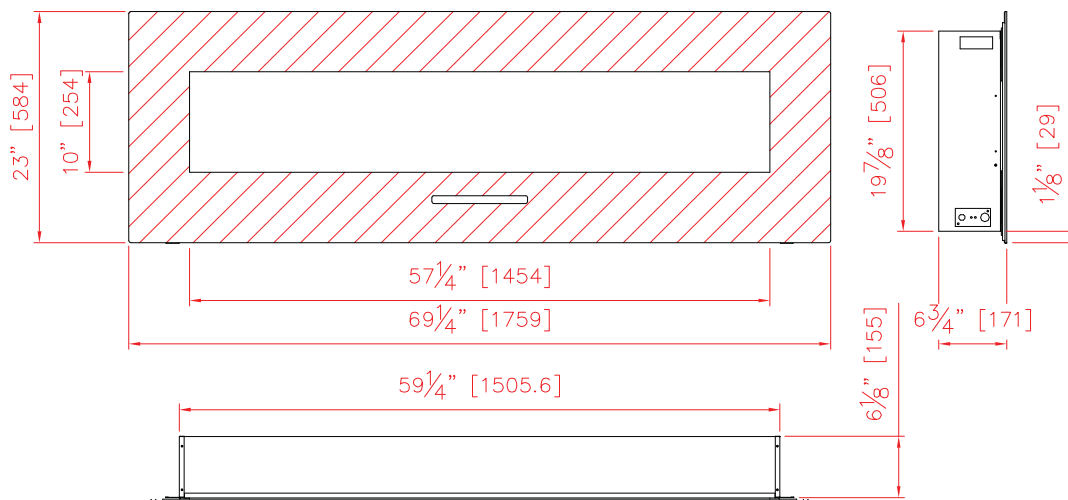

WM-FM-72-8123-BG (WM-G190072-1)

Description	Built-in or Wall Mount Appliance
Voltage	120V AC 60Hz
Watts	1500W Max
NO HEATER	25W
MOTOR HEATER	19W
Appliance Width	71" or 180.4 cm
Appliance Height	19 7/8" or 50.6 cm
Appliance Depth	6 1/8" or 15.5 cm
Gross Weight	113.3lbs or 51.5kg
Plug Location	Left side
Cord Length	70 7/8" or 180 cm
Rough Wall Opening Size	72 1/2" × 20 1/2" or 184 cm × 52 cm
BTU	5118

This appliance has been tested in accordance with the UL Standard 2021 for fixed and location dedicated electric room appliances in the United States and Canada. If you need assistance during installation, please contact your local dealer.

NOTE: This appliance must be electrically wired and grounded in accordance with local codes. In the absence of local codes, use the current CSA C22.1 Canadian Electrical Code in Canada or the ANSI/NFPA 70 National Electrical Code in the United States.

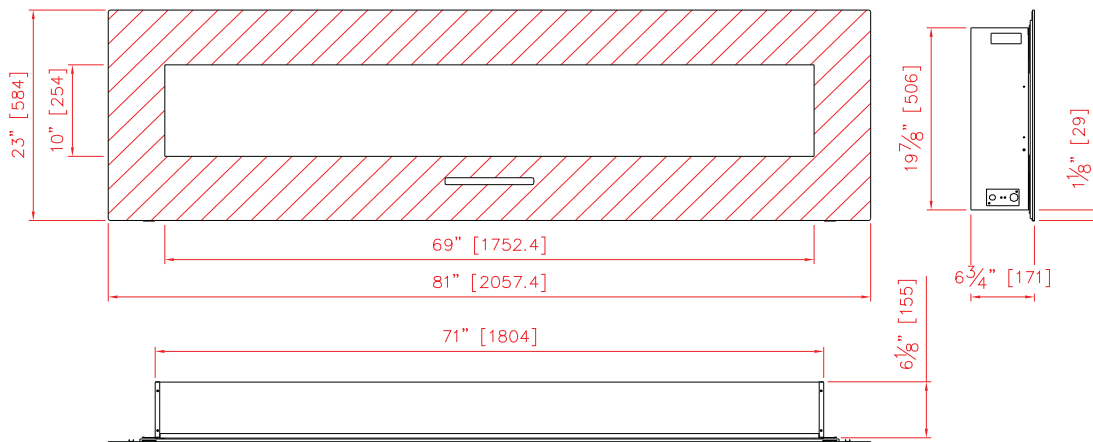

WM-FM-88-10023-BG (WM-G190088-1)

Description	Built-in or Wall Mount Appliance
Voltage	120V AC 60Hz
Watts	1500W Max
NO HEATER	25W
MOTOR HEATER	19W
Appliance Width	88" or 223.6 cm
Appliance Height	19 7/8" or 50.6 cm
Appliance Depth	6 1/8" or 15.5 cm
Gross Weight	138.6lbs or 63kg
Plug Location	Left side
Cord Length	70 7/8" or 180 cm
Rough Wall Opening Size	89 1/2" × 20 1/2" or 227.3 cm × 52 cm
BTU	5118

This appliance has been tested in accordance with the UL Standard 2021 for fixed and location dedicated electric room appliances in the United States and Canada. If you need assistance during installation, please contact your local dealer.

NOTE: This appliance must be electrically wired and grounded in accordance with local codes. In the absence of local codes, use the current CSA C22.1 Canadian Electrical Code in Canada or the ANSI/NFPA 70 National Electrical Code in the United States.

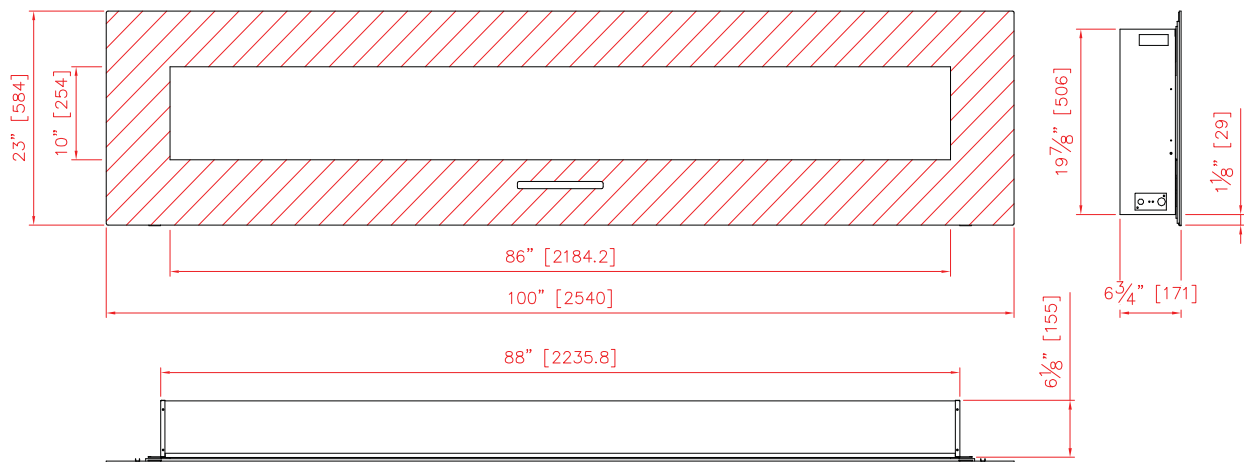

REMOVING FRONT GLASS

Models WM-FM-26-3623-BG , WM-FM-36-4423-BG , WM-FM-48-5823-BG and WM-FM-60-7023-BG each have 2 screws that secure the front glass in place. Models WM-FM-72-8123-BG and WM-FM-88-10023-BG have four screws secure the front glass in place.

Two people are required for the installation process.

1. The back-lighting LED is located on the back of the glass. Before removing the glass you must unplug the back-lighting from the unit. This plug is located at the bottom left hand side behind the front of the glass.

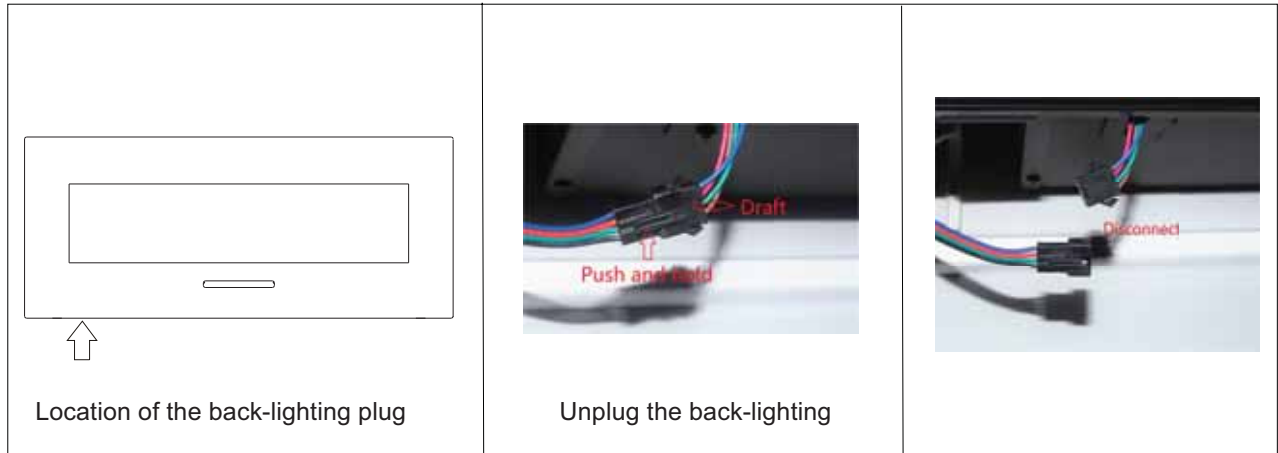

2. The screws are located on the sides of the unit. Once located, unscrew the two or four screws. You can then lift the front glass from the 4 shoulder posts on the sides of the unit and remove the glass.

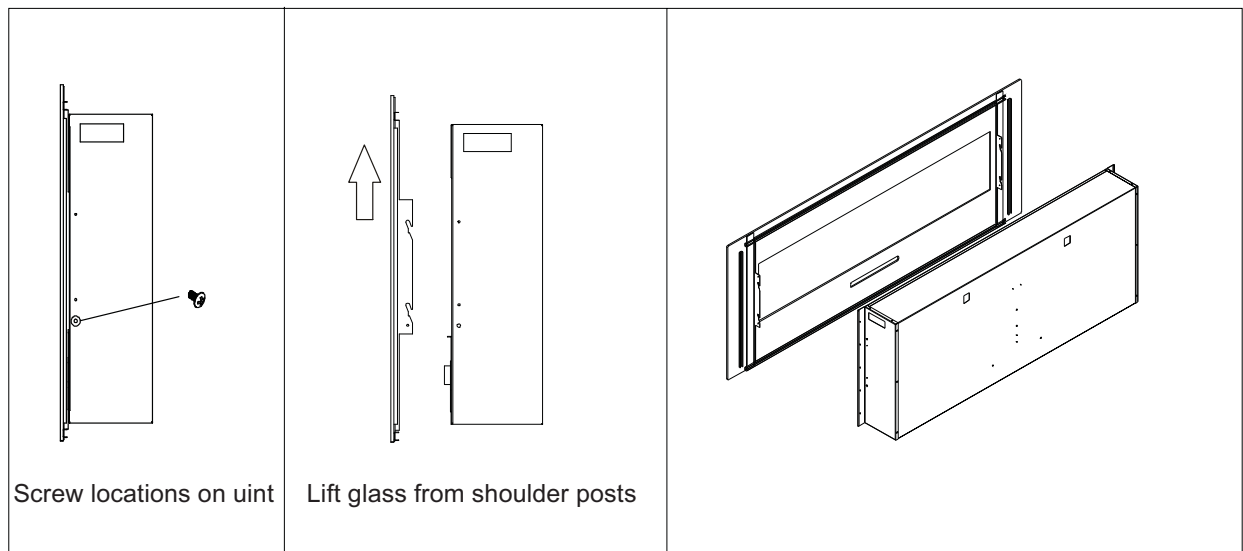

3. To replace the glass, lift onto the 4 shoulder posts. For a Wall Mount installation, replace the two or four screws to secure the glass. For Flush Mount installs it is not possible to replace the screws.

INSTALLATION WALL-MOUNT

NOTE: Due to the many different materials used on different walls, it is highly recommended that you consult your local builder before you install this appliance.

1. Select a location that is not prone to moisture and is located at least 0.91 m or 3 feet away from combustible materials such as curtains or drapes, furniture, bedding, paper, etc.
2. Referring to Fig. 1 below select a suitable position in which to mount the heater horizontally – use a spirit level to achieve this.
3. Check the wall to ensure there is no wiring, pipe wires etc in the area to be drilled. Drill 8 or more holes (8mm diameter & 40mm depth) using a suitable size drill and put the wall plugs into the holes.
4. Take out the hanger from the fireplace by unscrew the screw. Referring to Fig.2.
5. Referring to Fig. 3, fix the hanger to the wall.
6. Referring to Fig. 4, avoid fireplace to move, use screw fix fireplace to wall.

Warning!

Be sure that the bolts have been fixed firmly enough to withstand the weight !

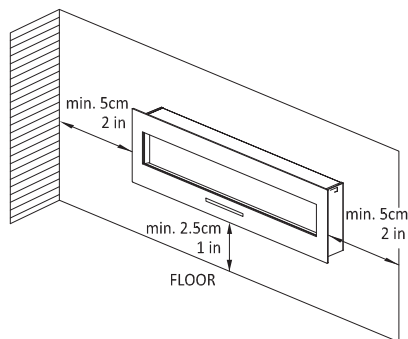

Fig. 1

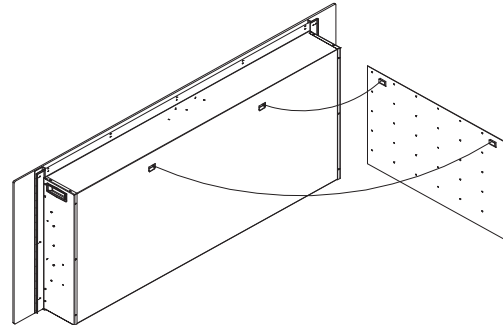

Fig. 2

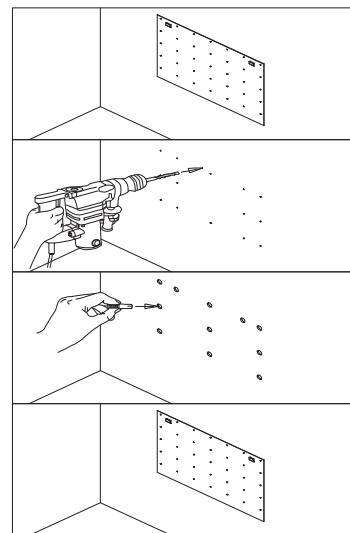

Fig.3

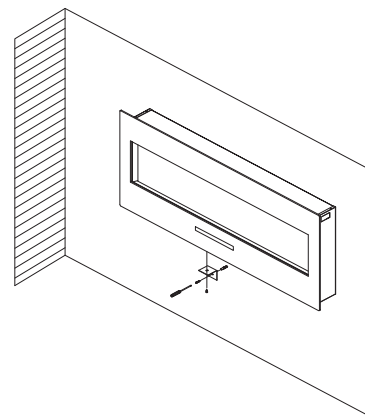

Fig. 4

INSTALLATION- BUILT-IN

NOTE: Due to the many different materials used on different walls, it is highly recommended that you consult your local builder before you install this appliance.

1. Select a location that is not prone to moisture and is located at least 0.91m or 3 feet away from combustible materials such as curtains or drapes, furniture, bedding, paper, etc.
2. Mark the desired location on the floor and store appliance in a safe, dry and dust free location.
3. Prepare a wall with a framed opening to accommodate the size of your unit. Leave at least 1/4" (6 mm) around the edge of the appliance. Any new wiring must be done in compliance with local and national codes and other applicable regulations.

Note: Fireplace must stick out of the wall a minimum of 1/2" or 1.5 cm.

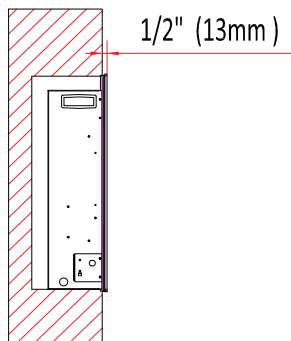

Prior to installing the appliance, test to make sure the appliance operates properly by plugging the power supply cord into a conveniently located 120 Volt grounded outlet.

The rough wall opening size of the fireplace:

	W(“)	D(“)	H(“)
WM-FM-26-3623-BG	27	6 1/2	20 1/2
WM-FM-34-4423-BG	35	6 1/2	20 1/2
WM-FM-48-5823-BG	49	6 1/2	20 1/2
WM-FM-60-7023-BG	60 5/8	6 1/2	20 1/2
WM-FM-72-8123-BG	72 1/2	6 1/2	20 1/2
WM-FM-88-10023-BG	89 1/2	6 1/2	20 1/2

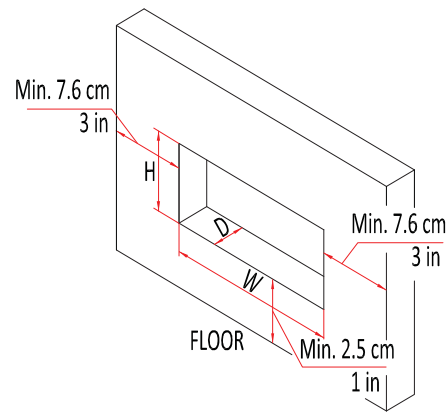

1. Take the front glass off from the unit. Put the brackets on the both sides and top of the fireplace as shown below.

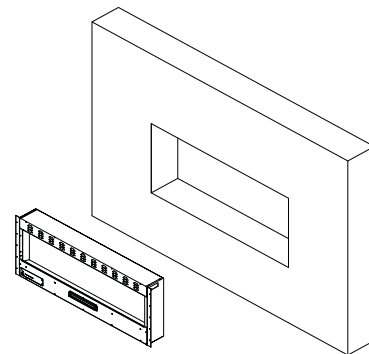

2. Lift fireplace and insert into opening.
3. Make sure that the power supply port is not behind the wall.
4. Level the fireplace.
5. Drive mounting screws into the mounting brackets on the unit and the wall studs.

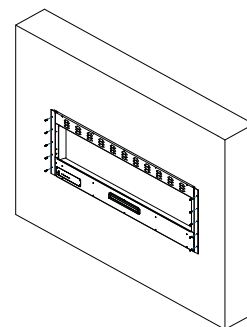

6. Replace glass and plug in back-lighting LED. See page 11.

MANTEL CLEARANCE

The clearance to the mantel should be 1" minimum when a mantel is applied (Measurement is taken from glass front).

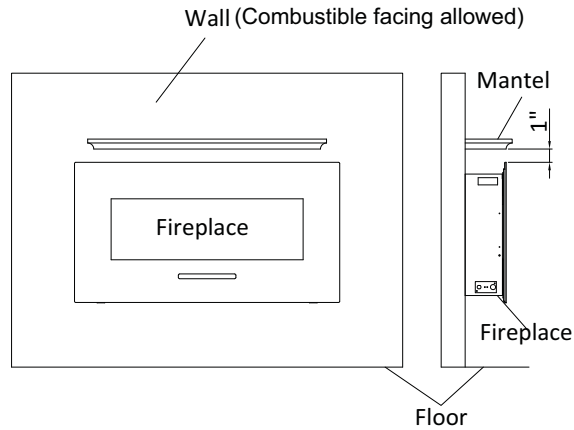

HARDWARE INSTALLATION

Turn off the appliance completely and let cool before servicing. Only a qualified service person should service and repair this electric appliance.

If it is necessary to hard wire this appliance, a qualified electrician must remove the cord connection, and wire the appliance directly to the household wiring.

This appliance must be electrically connected and grounded in accordance with local codes, if hard wired. In the absence of local codes, use the current CSA C22.1 CANADIAN ELECTRICAL CODE in Canada or the current ANSI/NFPA 70 NATIONAL ELECTRICAL CODE in the United States.

1. Remove the cover plate from the left side of the appliance by removing the two screws, as shown below. Unscrew and remove power cord.



2. Attach the wiring to the junction block. Please make sure the live wire goes into the "L", the neutral wire into "N" and the ground wire into "G".



3. Put the plate back and screw back.

MEDIA OPTIONS

The fireplace shipped with Birch log set, amber glass and Vermiculite. Consumers may purchase optional decorative media if they choose. See dealer for more details.



Birch log set



Amber glass

Vermiculite

DECORATIVE MEDIA INSTALLATION

1. Unplug the unit from the power.
2. Unscrew 2 screws on both left and right side of the unit to take off the front glass panel. Three people are recommended during this process. Hold the front glass panel with care.

Unscrew
before
you lift
glass

3. Pour the fire glass media into the tray. Feel free to use any combination of fire glass media that you find most appealing. Put back the front glass after you finish install the fire glass.









OPERATION

The Fireplace operates by using either the touch panel located on the upper left hand corner or by remote control.

Plug the fireplace into a 15 Amp wall socket.

MANUAL OPERATION













1. Press  to turn on and off the fireplace.
2. Press  to adjust the flame brightness. There are 6 brightness levels (L6-L1) and an off(OFF) position. Each time the flame button is pressed, the brightness of the flame decrease.
press the flame button for 10 seconds, the timing indicator light on and will rapidly blinks, at this time, You can use the TuyaSmart APP to connect to the fireplace.
3. Press  to adjust the ember Bed /Moodlight brightness. There are 11 brightness levels (d11-d2), dynamic condition(d1) ,and the OFF(OFF) setting you can cycle through.
4. Press  to set the turn-off time, 30min-1h-2h-3h-4h-5h-6h-7h-8h-t0. The indicator light the current timing. If the timing in off position, the second press will show 30. Multiple times to set operating duration to OF, 30 min, 1h, 2h, 3h, 4h, 5h, 6h, 7h, 8h.
5. Press  or the first time to display the current setting temperature , press the button again to clear the current temperature. If the heater in off position, the second press will show 22 (72).Multiple times to set ambient temperatures at 22 (72) , 23 (74) ,24 (76) , 25 (78) , 26 (80) , 27 (82) , 28 (84) ,15 (52) , 16 (54) , 17 (56) ,18 (58) , 19 (60) , 20 (62) , 21 (64) .
Temperature unit convert functionZ When the heater is on, press and hold the “  ” Button for 5 seconds, current temperature unit display will convert to another temperature unit.

REMOTE CONTROL OPERATION





For remote to function make sure the fireplace is plugged in and the remote has batteries.





Important: When operating the remote make sure you point the remote to the center of the fireplace. Each time you press the button, the buzzer inside the unit will beep once. It takes some time for the receiver to respond to the transmitter. Do not PRESS the buttons more than once within two seconds for correct operation.

Set the current time of the remote control

Press the  to activate the remote control and press to set  the time and date. When one of the “Sun” “Mon” “Tue” “Wed” “Thu” “Fri” “Sat” is flashing, press  or  to set the day of the week, press  to confirm day of the week and then enter hour setting. Press  or  to set the hour, press  to confirm the hour and then enter minute setting. Press  or  to set the minute and press  to confirm the minute and finish time setting.





-  Press this Power button to turn on and off the fireplace.
-  Press this Timer button to set the time to turn off the fireplace. The available settings range from 30 minutes to 8 hours. As shown in the following: 0:30 - 1:00 - 1:30 - 2:00 - 2:30 - 3:00 - 3:30 - 4:00 - 4:30 - 5:00 - 5:30 - 6:00 - 6:30 - 7:00 - 7:30 - 8:00. Once you have set the timer, the  icon will be displayed on the LCD screen of the remote control. Press this button again to cancel the timer setting and the icon disappears.
-  Each time the Heater Button is pressed, the power of the heater will change. As shown the following: H1- H2- AUTO (22) - OFF (no display)
H1 means the fireplace on Low Heat/750W.
H2 means the fireplace on High Heat/1500W.

AUTO means fireplace can automatically adjust to the temperature you set. When in AUTO, you can set the desired temperature with  or  keys. You can switch temperature between Celsius and Fahrenheit with  or  keys. When it is on Auto mode, fireplace operate at 1500W.





Press this button to adjust the speed of the flame. There are 3 options: High- Medium- Low.













The Ember bed /moodlight Button turn the ember bed or moodlight on and off. When in on position, the display screen of the remote control shows AD1., when the number "1" flash, you can set the color with  or  keys. There are 10 different colors (AD1-10) and dynamic condition (AD11) to choose from.







Press the Flame button to turn on and off the Flame. When in ON position, the LCD screen of the remote control shows 6 6 6. Press  or  or  to change the brightness of each color flame.







7 Day Timer Function

Press  once, 7 days from Monday to Sunday will display on the LCD screen of the remote control, press  within 5 seconds to enter 7 day timer function. When "Sun" flashes, press  or  to select the day that you want to set, press  to confirm your setting. Then "ON" will be display on the LCD screen of the remote control, at the same time, digital of time hour flashes, press  or  to set the time to turn the fireplace on. After setting the startup time, "OFF" will be displayed on the LCD screen and press  or  to set the shutdown time. When the shutdown time's set, "AUTO" will be displayed on the LCD screen of the remote control and the digital of temperature flashes. At this time, you can set the temperature by  or . Now, you have finished setting of this function.

When the 7 day timer's set, the icon  will be displayed on the LCD screen of the remote control. Press  again to cancel the 7 day timer and the icon  will disappears.

NOTE: If the 7 day timing  and the general timing  are set at the same time, the system will respond to an earlier shutdown time.

 Press Refer button to check the settings of 7 day timer. Press  or  to see the settings of the day of the week and  or  the settings of the startup and shutdown time.

WIFI OPERATION

INSTALL TuyaSmart life

There are 2 ways to install TuyaSmart;

1. Search for “TuyaSmart life” in the APP store on your phone, download and install.
2. Scan the QR code below with your mobile phone.



WIFI SETTING AND FIREPLACE OPERATION

1. Create an account and log in.
2. When you log in, touch “+” (FIG.1) to enter in FIG.2. Touch “others” on the left corner first and then choose “Connector (Wi-fi)” to enter in FIG.3 to set your Wi-fi account and password.

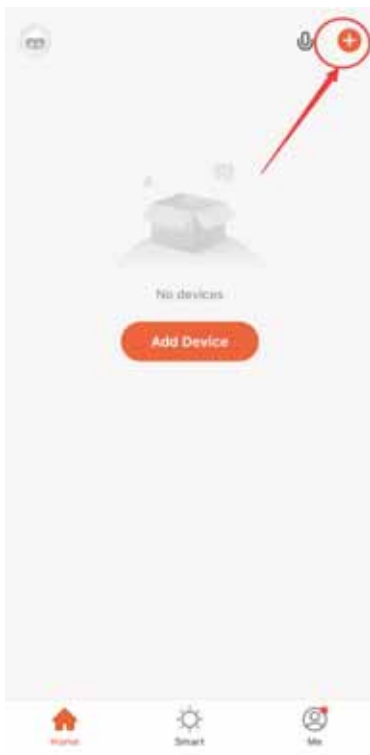

FIG.1



FIG. 2



FIG.3

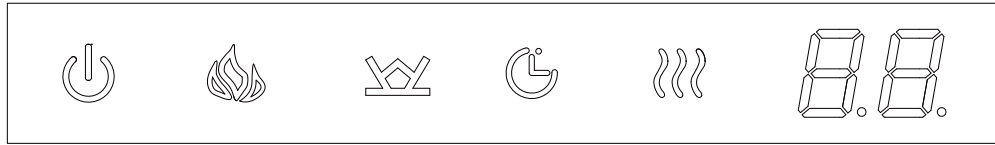

FIG.4



3. Press  (flame button) on the touch panel of the fireplace for more than 5 seconds when the fireplace in standby mode. There will be 2 beeps come out from the fireplace and the  (flame button) will flash as well indicating that Wi-fi is in EZ mode. Then please confirm to go next. (FIG.5)
4. The APP will scan (FIG.6) and add the fireplace to APP (FIG.7) automatically. Please make sure the Wi-fi account and password you set are correct and Wi-fi signal is good.
5. Touch “Done” to finish Wi-fi setting.(FIG.7)



FIG.5

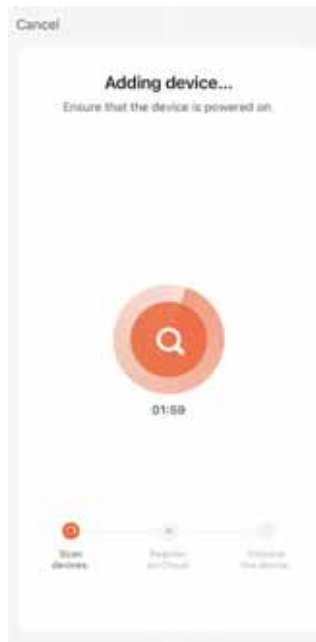

FIG.6



FIG.7

6. Now you are in the interface like FIG.7. You can operate the fireplace via Wi-fi.

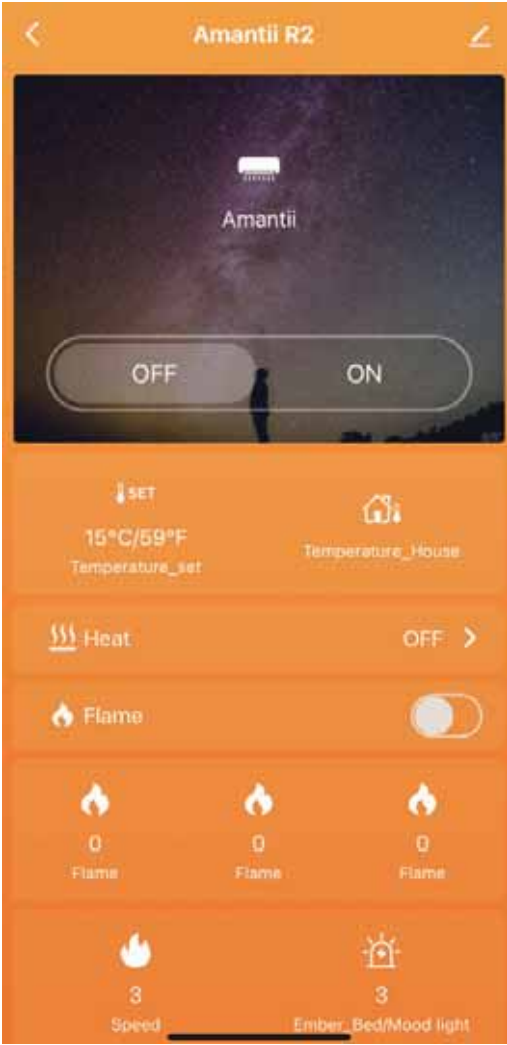

FIG.7

NOTE: Turn off the flashing blue Wifi indicator light



Touch the  (power button) once, the blue light will stop flashing.

REPLACEMENT PARTS

Ref.	Description	Quantity	WM-FM-26-3623-BG (WM-G190026-1)	WM-FM-34-4423-BG (WM-G190034-1)	WM-FM-48-5823-BG (WM-G190048-1)	WM-FM-60-7023-BG (WM-G190060-1)	WM-FM-72-8123-BG (WM-G190072-1)	WM-FM-88-10023-BG (WM-G190088-1)
1	Trim	0	Not applicable	Not applicable	Not applicable	Not applicable	Not applicable	Not applicable
2	Adjustable screws	0	Not applicable	Not applicable	Not applicable	Not applicable	Not applicable	Not applicable
3	Front glass bracket	0	Not applicable	Not applicable	Not applicable	Not applicable	Not applicable	Not applicable
4	Front glass	1	10701203C	10701204C	10701205C	10701206C	10701207C	10701208C
5	Back glass	1	107021171	107021181	107021191	107021201	107021211	107021221
6	Tray glass	1	10702143C	10702144C	10702145C	10702164C	10702146C	10702165B
7	Side glass	0	Not applicable	Not applicable	Not applicable	Not applicable	Not applicable	Not applicable
8	Black glass - Left	0	Not applicable	Not applicable	Not applicable	Not applicable	Not applicable	Not applicable
9	Black glass - Right	0	Not applicable	Not applicable	Not applicable	Not applicable	Not applicable	Not applicable
10	Glass bracket - Left	1	32070005	32070005	32070005	32070005	32070005	32070005
11	Glass bracket - Right	1	32070006	32070006	32070006	32070006	32070006	32070006
12	Adjustable leveling feet	0	Not applicable	Not applicable	Not applicable	Not applicable	Not applicable	Not applicable
13	Flicker assembly for Flame	1	3241505B	3118507B	3119507D	3110503D	3058503D	3111503D
14	Flicker assembly for Tray	0	Not applicable	Not applicable	Not applicable	Not applicable	Not applicable	Not applicable
15	Flame motor	1	10101501B	10101501B	10101501B	10101501B	10101501B	10101501B
16	Heater / blower assembly	1	602082	602082	602082	602082	602082	602082
17	LED light set for flames	1	801200	801300	801400	801500	801600	801700
18	LED light set for ember bed / Tray lighting	1	813200	813300	813400	813242	814400	803244

REPLACEMENT PARTS

Ref.	Description	Quantity	WM-FM-26-3623-BG (WM-G190026-1)	WM-FM-34-4423-BG (WM-G190034-1)	WM-FM-48-5823-BG (WM-G190048-1)	WM-FM-60-7023-BG (WM-G190060-1)	WM-FM-72-8123-BG (WM-G190072-1)	WM-FM-88-10023-BG (WM-G190088-1)
19	Moodlight	1	3117509B	3118509B	3119509B	3120509B	3121509B	3122509
20	Temperature sensor	1	10114001B	10114001B	10114001B	10114001B	10114001B	10114001B
21	Remote signal receiver	1	601002B	601002B	601002B	601002B	601002B	601002B
22	Remote control	1	10105501	10105501	10105501	10105501	10105501	10105501
23	Circuit board	1	10124129	10124129	10124129	10124129	10124129	10124129
24	AC adapter	1	10116003	10116003	10116003	10116003	10116003	10116003
25	Circuit board for touch panel	1	10124003	10124003	10124003	10124003	10124003	10124003
26	Circuit board for touch pad	0	Not applicable	Not applicable	Not applicable	Not applicable	Not applicable	Not applicable
27	WiFi card	1	212051	212051	212051	212051	212051	212051
28	Bluetooth speaker set (Set includes: Power circuit board, speaker circuit board & speaker)	0	Not applicable	Not applicable	Not applicable	Not applicable	Not applicable	Not applicable
29	Speaker set (Set includes: Power circuit board, speaker circuit board & speaker)	0	Not applicable	Not applicable	Not applicable	Not applicable	Not applicable	Not applicable
30	Power cord	1	10103014	10103014	10103014	10103014	10103014	10103014

*Items may not appear exactly as illustrated

*Front glass comes with moodlight

EXPLODED VIEW

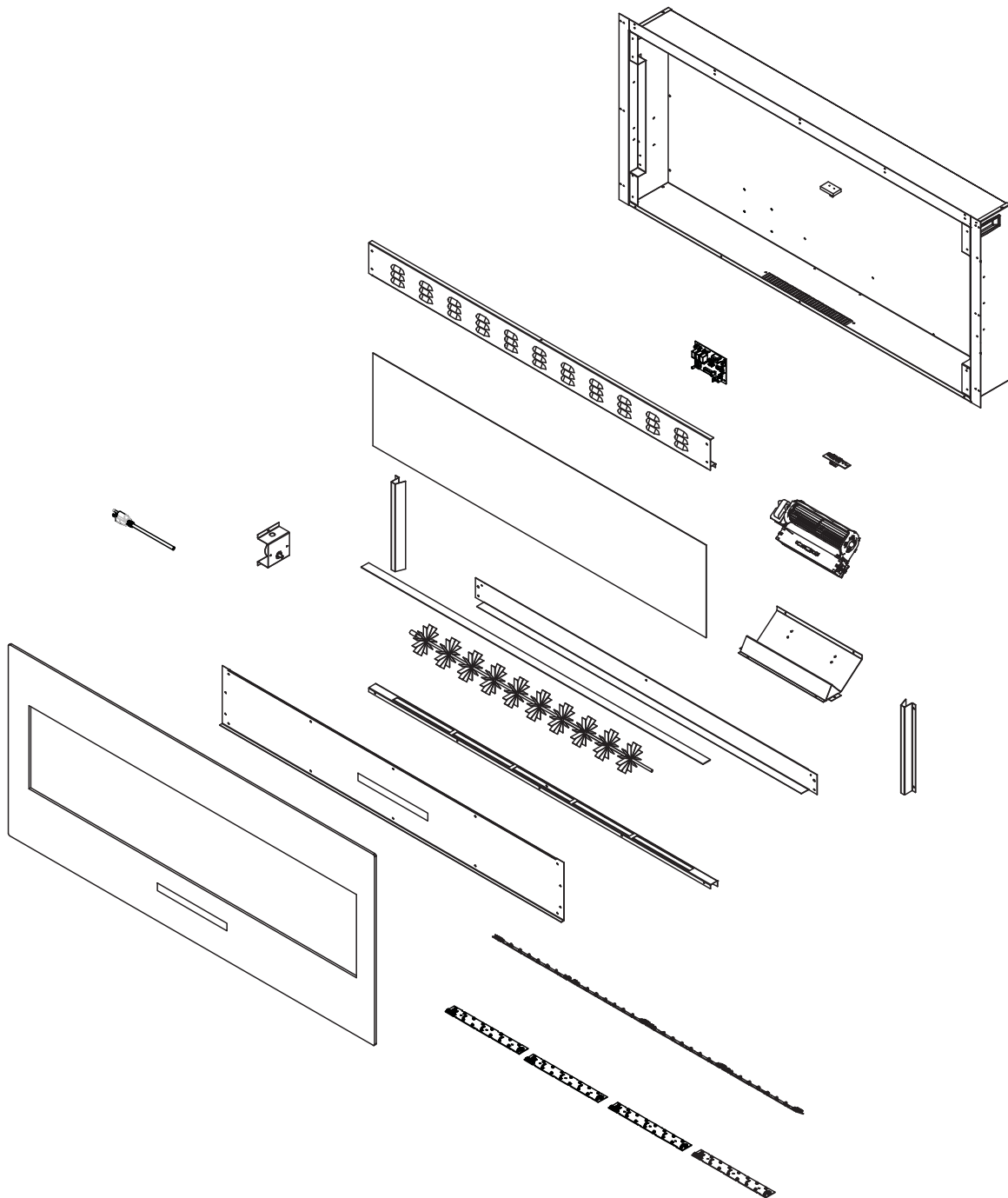

TRUBLE SHOOTING

PROBLEM	POSSIBLE CAUSE	SOLUTION
Dim or no flame	Flame LED's are burnt out	Inspect the LED's and replace them if necessary.
Ember bed is not glowing or dimming	Ember LED's are burnt out	Inspect the ember bed LED's and replace them if necessary.
Appliance turns off and will not turn on	Appliance has overheated and safety device has caused the thermal switch to disconnect	Turn off the main switch, allow appliance to cool for 10 minutes, then turn it on.
	House circuit breaker has tripped	Reset house circuit breaker.
	Appliance's fuse has blown	Replace the fuse.
Appliance will not come on when switch is flipped to ON	Appliance is not plugged into an electrical outlet	Check plug and plug in.
	Appliance has overheated and safety device has caused the thermal switch to disconnect	Turn off the main switch, allow appliance to cool for 10 minutes, then turn it on.
	Circuit board is burnt out	Inspect the circuit board and replace it if necessary.
No warm air coming out of appliance	Heater is burnt out	Inspect the burner and heater assembly and replace it if necessary.
Flame sputters	Flame motor is defective.	Call a qualified service technician and replace flame motor.
Remote Control does not work.	Low batteries. Unit switch in "O" position.	Replace AAA batteries in remote control. Turn the switch in "I" position.
Flame is fixed.	Wiring may be loose or the flame motor may be defective.	

SERVICE HISTORY

This heater must be serviced annually depending on usage.

Date	Dealer Name	Service technician Name	Service Performed	Special Concerns

NOTES:

ELECTRIC FIREPLACE WARRANTY

FOR PRODUCTS MANUFACTURED AFTER JANUARY 1, 2016



Amantii Imports Corp. ("Amantii") warrants that your newly purchased Amantii electric fireplace is free from manufacturing and material defects for a period of two (2) years from the date of the first purchase, subject to the conditions and limitations contained below.

WARRANTY APPLICATION & EXCLUSIONS

This limited warranty applies to your newly purchased Amantii electric fireplace; the limited warranty's application is limited to purchases made in any province of Canada or in any of the 52 States of the United States of America, including the District of Columbia. Only the original purchaser of the product is eligible for coverage under this limited warranty; the warranty is not transferable.

PRODUCTS EXCLUDED FROM THIS LIMITED WARRANTY

Light bulbs are not covered by this limited warranty and are the sole responsibility of the owner/purchaser.

WARRANTY COVERAGE AND TERM

Products covered by this limited warranty have been tested and inspected prior to shipment and, subject to the provisions of this warranty, Amantii warrants such products to be free from defects in material and workmanship for a period of two (2) years from the date of the first purchase of such products.

The limited two (2) year warranty period for products also applies to any implied warranties that may exist under applicable law. Some jurisdictions do not allow limitations on how long an implied warranty lasts, so the above limitation may not apply to the purchaser.

All other warranties—expressed or implied—with respect to the product, its components and accessories or any obligation/liabilities on the part of Amantii are hereby expressly excluded.

WARRANTY COVERAGE AND TERM - BESPOKE SERIES

Products covered by this limited warranty have been tested and inspected prior to shipment and, subject to the provisions of this warranty, Amantii warrants such products to be free from defects in material and workmanship for a period of five (5) years from the date of the first purchase of such products.

The limited five (5) year warranty period for products also applies to any implied warranties that may exist under applicable law. Some jurisdictions do not allow limitations on how long an implied warranty lasts, so the above limitation may not apply to the purchaser.

All other warranties—expressed or implied—with respect to the product, its components and accessories or any obligation/liabilities on the part of Amantii are hereby expressly excluded.

LIMITATIONS TO COVERAGE UNDER LIMITED WARRANTY

This limited warranty does not apply to products that have been repaired, except by Amantii or its authorized service representatives, or otherwise altered. This limited warranty further does not apply to defects resulting from misuse, abuse, accident, neglect, incorrect installation, improper maintenance or handling, or operation with an incorrect power source. Products made by other manufacturers, sold with the product or thereafter, are not covered by this limited warranty. The use of unauthorized components will render this warranty null and void.

PANORAMA OUTDOOR UNITS

All Panorama units that are installed outdoors or in moisture intense conditions must use the stainless steel cover. Proof of purchase of the cover is required for any warranty claims.

SERVICE UNDER LIMITED WARRANTY

Defects must be brought to the attention of Amantii Technical Support by contacting Amantii at (1.877.850.9458), or at 502-1027 Davie Street, Vancouver, BC V6E 4L2. Please have your proof of purchase, catalogue/model and serial numbers available when calling; any and all service under the limited warranty requires a proof of purchase of the product.

DEFECTS

Should a product or part covered by this limited warranty be proven to be defective, in material or workmanship, and during the two (2) year limited warranty period, Amantii will replace such defective product or part without charge. If Amantii is unable to replace such product, or if replacement is not commercially practicable or cannot be timely done, in its sole discretion Amantii may, in lieu of replacement, choose to refund the purchase price for such product or part.

ELECTRIC FIREPLACE WARRANTY

FOR PRODUCTS MANUFACTURED AFTER JANUARY 1, 2016

APPLICATION OF PROVINCIAL AND STATE LAW

This limited warranty gives you specific legal rights, and you may also have other rights which vary from jurisdiction to jurisdiction. The provisions of the United Nations Convention on Contracts for the Sale of Goods shall not apply to this limited warranty or the sale of products covered by this limited warranty.

GENERAL

Amantii reserves the right to make changes at any time without notice, in design, material, specifications, prices and the right to discontinue styles and products.

GLASS

This limited warranty does not apply to the following glass products:

Model Type	Tray Glass	Front Glass	Back Glass
Panorama /Symmetry	✓	✓	✓
Wall Mount/ Insert	✓		
Traditional	✓		
Zero Clearance/ FS	✓		
Freestand	✓		

EXCLUSION OF BATTERIES

Ocean carriers have set new rules designed to protect the safety of shipments while in transit. This new rule disallows the inclusion of lithium/alkaline batteries, as a result we will no longer be including batteries with the fireplace remote.

REPLACEMENT MOTORS

With the reliability of the components used in the construction of our electric fireplaces, a complimentary replacement motor will no longer be included inside the carton containing the fireplace.