

Owner's Manual

Operation & Care

INSTALLER: Leave this manual with party responsible for use and operation.
OWNER: Retain this manual for future reference.

Contact your dealer with questions on installation, operation, or service.

VERMONT  CASTINGS™
BY FORGE & FLAME

GIFFORD WOOD INSERT

MODEL NUMBERS:
GIFFORD-CB
GIFFORD-BM

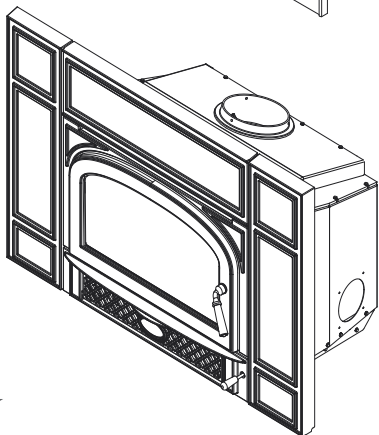
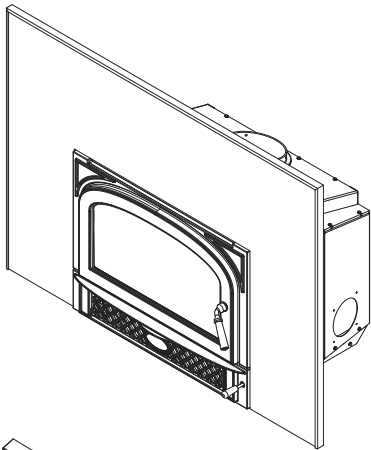

PFS®
C US

Installation and service of this appliance should be performed by qualified personnel. Hearth & Home Technologies recommends HHT Factory Trained or NFI certified professionals.

hearthED
FACTORY TRAINING
Fuel Your Fire

NFI NATIONAL
FIREPLACE
INSTITUTE®
A CERTIFICATION AGENCY



WARNING



If the information in these instructions is not followed exactly, a fire may result causing property damage, personal injury, or death.

- Do not store or use gasoline or other flammable vapors and liquids in the vicinity of this or any other appliance.
- Do not over fire - If heater or chimney connector glows, you are over firing. Over firing will void your warranty.
- Comply with all minimum clearances to combustibles as specified.

Failure to comply may cause house fire.



WARNING



HOT SURFACES!

Glass and other surfaces are hot during operation AND cool down.

Hot glass and appliance will cause burns.

- Do not touch glass until it is cooled
- Use leather gloves when reloading fuel
- NEVER allow children to touch glass
- Keep children away
- CAREFULLY SUPERVISE children in same room as appliance.
- Alert children and adults to hazards of high temperatures
- High temperatures may ignite clothing or other flammable materials.
- Keep clothing, furniture, draperies and other flammable materials away.



WARNING



Fire Risk.

For use with solid wood fuel only. Other fuels may over fire and generate poisonous gases (i.e. carbon monoxide).

NOTE: To obtain a French translation of this manual, please contact your dealer or visit www.forgenflame.com
REMARQUE : Pour obtenir une traduction française de ce manuel, s'il vous plaît contacter votre revendeur ou visitez www.forgenflame.com

Congratulations

and Welcome to the Vermont Castings Family!

NOTE: Clearances may only be reduced by means approved by the regulatory authority having jurisdiction

A. Sample of Serial Number / Safety Label

LOCATION: UNDER ASH LIP, PULL OUT TO VIEW

LISTED ROOM HEATER, SOLID FUEL TYPE
"For Use with Solid Wood Fuel Only."
 Also for use in Mobile Home.
PREVENT HOUSE FIRES

Install and use only in accordance with manufacturer's installation, venting and operating instructions.
 CONTACT YOUR LOCAL BUILDING OR FIRE OFFICIALS ABOUT RESTRICTIONS AND INSTALLATION INSPECTION IN YOUR AREA
 Refer to manufacturer's instructions and local codes for precautions required for passing chimney through a combustible wall or ceiling.
WARNING - For Mobile Homes: Do not install in a sleeping room. An outside combustion air inlet must be provided and unrestricted while unit is in use. The structural integrity of the mobile home floor, ceiling and walls must be maintained. The insert must be properly grounded to the frame of the mobile home. A complete relining of the chimney system with a 6 inch (152mm) diameter listed stainless liner is required. Must be equipped with a spark arrestor cap. Outside Air comes standard on the insert and must be installed before operating insert.
 When used as a masonry insert stove, install only in a masonry fireplace built to national and/or local codes. Do not remove brick or mortar to accommodate insert. Installation requires a 5 foot minimum length of a starter pipe into existing chimney with airtight face seal. A full reline with listed liner strongly recommended.
 Install only on a non-combustible hearth.
 Approved for installation and use in factory built zero-clearance fireplaces conforming to minimum fire chamber specifications. A complete relining of the chimney system with a 6 inch (152mm) diameter listed stainless liner is required.
 In Canada a full length 6 inch (152mm) S635 flue liner is required as per ULC S628-93.
WARNING - Inspect and clean chimney frequently. Under certain conditions of use, creosote buildup may occur rapidly.
 Do not connect this unit to a chimney serving another appliance.
DANGER: Risk of electrical shock. Disconnect power supply before servicing. Route power cord away from unit. Do not route cord under or in front of appliance.
 Electrical Rating: 115 VAC 1.4 AMPS 60 Hz
 Do not use grate or elevate fire. Build wood fire directly on hearth. Do not overfire. If heater or chimney connector glows, you are overfiring. Operate with door closed. Open only to add fuel to the fire. Replace glass only with 5mm ceramic glass available from your dealer.



Minimum Clearance to Combustible	Material	Serial
Masonry, Heat	Factory-Built	Number
Refer to Clearances	Other	Canada
USA ONLY		
A	Sidewall to Center of Appliance	24.5 in.
B	Mantel to Bottom of unit	44.75 in.
C	Top of unit to Bottom of Mantel	42.5 in.
D	Side Trim to Appliance	23.75 in.
E	Hearth Extension from Glass	16 in.
F	Hearth Extension from Loading Door	8 in.

Factory-Built Floor Protection under Hearth Extension

Thermal & Ember Protection
 Floor height 0 to 4.5 inches below
 Insert Base: Materials with R value of 2.9 required.
Ember Protection Only
 Greater than 4.5 inches below Insert Base.



CAUTION: HOT WHILE IN OPERATION DO NOT TOUCH, KEEP CHILDREN, CLOTHING AND FURNITURE AWAY. CONTACT MAY CAUSE SKIN BURNS. SEE NAMEPLATE AND INSTRUCTIONS.



21-670
21-661

VERMONT CASTINGS™
BY FORGE + FLAME

Models:
GIFFORD

Serial No. / N° de série

HF

CONFORMS TO UL1482 and CERTIFIED TO ULC STD S628

Mfg by: HEARTH+HOME
352 Mountain House Road
Halifax, PA 17032
www.forgeandflame.com

U.S. ENVIRONMENTAL PROTECTION AGENCY
 Certified to comply with 2020 crib wood particulate emission standards for single burn rate heaters. The single burn rate wood heater is not approved for use with a flue damper.
 This wood heater needs periodic inspection and repair for proper operation. Consult the owner's manual for further information. It is against federal regulations to operate this wood heater in a manner inconsistent with the operating instructions in the owner's manual.

YEAR CODE

25	26	27	28												
29	30	31	32	JAN	FEB	MAR	APR	MAY	JUNE	JULY	AUG	SEPT	OCT	NOV	DEC
33	34	35	36												

Date of Manufacture / Date de fabrication:

DO NOT REMOVE THIS LABEL Made in U.S.A. of U.S. and imported parts.

Test Lab & Report Number

Serial Number

Model Name

Mfg Date



Safety Alert Key:

- **DANGER!** Indicates a hazardous situation which, if not avoided will result in death or serious injury.
- **WARNING!** Indicates a hazardous situation which, if not avoided could result in death or serious injury.
- **CAUTION!** Indicates a hazardous situation which, if not avoided, could result in minor or moderate injury.
- **NOTICE:** Indicates practices which may cause damage to the appliance or to property.

TABLE OF CONTENTS

A. Sample of Serial Number / Safety Label 2
 B. Warranty 4
 C. Quick Start Guide 6

1 Listing and Code Approvals

A. Insert Safety Certification 7
 B. Insert Emissions Certification 7
 C. BTU & Efficiency Specifications 7
 D. Mobile Home Approved (USA only) 8
 E. Glass Specifications 8
 F. Sleeping Room 8
 G. California - Prop65 8

2 Operating Instructions

A. Your Wood Appliance 9
 B. Fire Safety 9
 C. Over firing Your Appliance 9
 D. Combustible/Non-combustible Materials 10
 E. Seasoned Wood 10
 F. Burning Process 10
 G. Automatic Combustion Control (ACC) 11
 H. Burn Rates and Operating Efficiency 11
 I. Wood Fuel 12
 J. Building A Fire 12
 K. Blower Control Box with Snap Disc 14
 L. Blower Operation 14
 M. Opacity (Smoke) 14
 N. Clear Space 14
 O. Negative Pressure 15
 P. Frequently Asked Questions 15

3 Maintenance and Service

A. Quick Reference Maintenance Guide 16
 B. Cleaning the Glass & Replacement 17
 C. General Maintenance 17
 D. Correct Baffle & Blanket Placement 19
 E. Baffle Board Replacement 20
 F. Tube Replacement 20

4 Troubleshooting Guide 22

5 Reference Materials

A. Service and Maintenance Log 23
 B. Service Parts List 25

➔ = Contains updated information

B. Warranty

Hearth & Home Technologies LLC LIMITED WARRANTY

Hearth & Home Technologies LLC (“HHT”) extends the following warranty for HHT gas, wood, pellet and electric hearth appliances (each a “Product” and collectively, the “Product(s)”) and certain component parts set forth in the table below (“Component Part(s)”) that are purchased from a HHT authorized dealer or distributor.

WARRANTY COVERAGE:

HHT warrants that the Products and their Component Parts will be free from defects in materials and workmanship for the applicable period of Warranty coverage set forth in the table below (“Warranty Period”). If a Product or Component Parts are found to be defective in materials or workmanship during the applicable Warranty Period, HHT will, at our discretion, repair the applicable Component Part(s), replace the applicable Component Part(s), or refund the purchase price of the applicable Product(s). The maximum amount recoverable under this Warranty is limited to the purchase price of the Product. This Warranty is transferable from the original purchaser to subsequent owners, but the Warranty Period will not be extended in duration or expanded in coverage for any such transfer. This Warranty is subject to conditions, exclusions, and limitations as described below.

WARRANTY PERIOD:

Warranty coverage begins at the date of installation. In the case of new home constructions, Warranty coverage begins six months after invoice of the final sale of the Product(s) by an independent, authorized HHT dealer or distributor. However, the Warranty coverage shall commence no later than 24 months following the date of Product shipment from HHT, regardless of the installation or purchase date.

Warranty Period		HHT Manufactured Appliances and Venting				
Component Parts	Labor	Gas	Pellet	Wood	Electric	Component Parts Covered by this Warranty
1 Year		X	X	X		All parts including handles, external enameled components and other material except as covered by Warranty Conditions, Warranty Exclusions, and Warranty Limitations listed
2 Years					X	All parts except as covered by Warranty Conditions, Warranty Exclusions, and Warranty Limitations listed
			X	X		Glass, Electrical components limited to heating element/igniters, Top feed auger assembly, Blowers, Junction Box, Remotes/Wall switches, linear actuator, power cord, vacuum switch, snap disc, wire harnesses and thermocouple
		X				Electrical components limited to modules, remotes/wall switches, valves, pilots, blowers, junction boxes, wire harnesses, transformers and lights (excluding light bulbs)
		X		X		Cement Refractory Panels, Glass Liner Panels
3 years			X			Firepots, burnpots, Harman mechanical feeders
5 years		X		X		Catalysts, Vented and Vent Free burners and logs
10 years	1 year	X				Burners, logs and metal/fiber refractory components of HHT manufactured fireplaces or stoves, venting due to poor workmanship
10 years	3 years		X	X		Castings, Medallions & Baffles, FlexBurn® System (engine, inner cover, access cover and fireback), Firebox and heat exchanger, HHT Chimney & Terminations, Manifolds
20 years	3 years	X				Firebox and heat exchanger
All purchased replacement parts and optional accessories						
1 Year	None	X	X	X	X	All purchased replacement parts and optional accessories

WARRANTY CONDITIONS:

- Because HHT cannot control the quality of any Products sold by unauthorized sellers, this Warranty only covers Products that are purchased through an HHT authorized dealer or distributor unless otherwise prohibited by law; a list of HHT authorized dealers is available on the HHT branded websites.
- This Warranty is only valid while the applicable Product remains at the site of original installation.
- This Warranty is only valid in the country in which the HHT authorized dealer or distributor that sold the applicable Product is authorized to sell applicable Product.
- Contact your installing distributor or dealer for Warranty service. If the installing dealer or distributor is unable to provide necessary parts, contact the nearest HHT authorized dealer or supplier. Additional service fees may apply if you are seeking Warranty service from a dealer other than the dealer from whom you originally purchased the applicable Product.
- No HHT consumer should bear cost of warranty service or costs incurred while servicing warranty claims (i.e., travel, gas, or mileage) when the service is performed within the terms of this Warranty. Check with your dealer or distributor in advance for any costs to you when arranging a warranty call. Travel and shipping charges for parts are not covered by this Warranty.

WARRANTY EXCLUSIONS:

This Warranty does not cover the following:

- Changes in surface finishes as a result of normal use. As a heating appliance, some changes in color of interior and exterior surface finishes may occur. This is not a flaw and is not covered under the Warranty.
- Damage to printed, plated, or enameled surfaces caused by fingerprints, accidents, misuse, scratches, melted items or other external sources and residues left on the plated surfaces from the use of abrasive cleaners or polishes.
- Repair or replacement of parts that are subject to normal wear and tear during the Warranty Period are not covered. These parts include: paint, wood and pellet gaskets, firebricks, wood grates, flame guides, batteries and the discoloration of glass.
- Minor expansion, contraction, or movement of certain parts causing noise. These conditions are normal and complaints related to this noise are not covered by this Warranty.
- Damages resulting from: (1) failure to install, operate, or maintain the applicable Product in accordance with the installation instructions, operating instructions, and listing agent identification label furnished with the applicable Product; (2) failure to install the applicable Product in accordance with local building codes; (3) shipping or improper handling; (4) improper operation, abuse, misuse, continued operation with damaged, corroded or failed components, accident, or improperly/incorrectly performed repairs; (5) environmental conditions, inadequate ventilation, negative pressure, or drafting caused by tightly sealed constructions, insufficient make-up air supply, or handling devices such as exhaust fans or forced air furnaces or other such causes; (6) use of fuels other than those specified in the operation instructions; (7) installation or use of components not supplied with the applicable Product or any other components not expressly authorized and approved by HHT; (8) modification of the appliance not expressly authorized and approved by HHT in writing; and/or (9) interruptions or fluctuations of electrical power supply to the applicable Product.
- Non-HHT venting components, hearth connections or other accessories used in conjunction with the applicable Product.
- Any part of a pre-existing fireplace system in which an insert or a decorative gas applicable Product is installed.
- HHT's obligation under this Warranty does not extend to the Product's capability to heat the desired space. Information is provided to assist the consumer and the dealer in selecting the proper Product for the application. Consideration must be given to the Product location and configuration, environmental conditions, insulation and air tightness of the structure.

This warranty is void if:

- The applicable Product has been over-fired, operated in atmospheres contaminated by chlorine, fluorine, or other damaging chemicals. Over-firing can be identified by, but not limited to, warped plates or tubes, deformation/warping of interior cast iron structure or components, rust colored cast iron, bubbling, cracking and discoloration of steel or enamel finishes.
- The applicable Product is subjected to prolonged periods of dampness or condensation.
- There is any damage to the applicable Product due to water or weather damage which is the result of, but not limited to, improper chimney or venting installation.

LIMITATIONS OF REMEDIES AND LIABILITY:

- **EXCEPT TO THE EXTENT PROVIDED BY LAW, HHT MAKES NO EXPRESS WARRANTIES OTHER THAN THE WARRANTY SPECIFIED HEREIN. The owner's exclusive remedy and HHT's sole obligation under this Warranty or in contract, tort or otherwise, shall be limited to, at HHT's sole option, replacement of the Component Part(s), repair of the Component Part(s), or refund of the original purchase price of the applicable Product(s). In no event will HHT be liable for any incidental or consequential damages caused by defects in the applicable Product. Some States do not allow the exclusion or limitation of incidental or consequential damages, so the above limitation or exclusion may not apply to you. This Warranty gives you specific legal rights and you may also have other rights which vary from State to State. THE DURATION OF ANY IMPLIED WARRANTY IS LIMITED TO DURATION OF THE EXPRESSED WARRANTY SPECIFIED ABOVE FOR THE APPLICABLE PRODUCT. Some States do not allow limitations on how long an implied warranty lasts, so the above limitation may not apply to you.**

C. Quick Start Guide

NOTE: These are generic drawings and may not represent your specific model.

ITEMS NEEDED FOR FIRST FIRE: 10 Pieces of Newspaper, 10-20 Pieces of Dry Kindling and Few Pieces of Dry Split Wood.

**ACTIVATE
Start-Up Air Control**

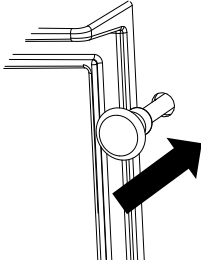

1

LOAD WOOD

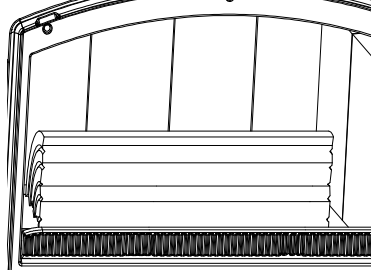

2

ADD NEWSPAPER

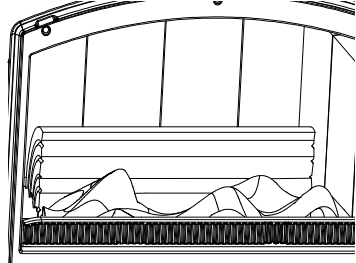

3

ADD KINDLING

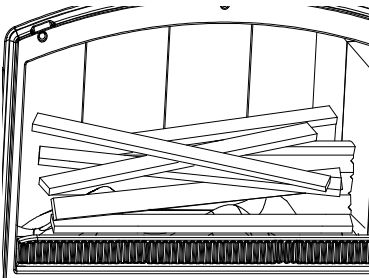

LIGHT THE PAPER

4

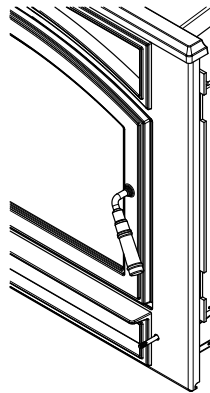

Warning! Risk of Fire.

Close and securely latch the door after the fire has started, and after refueling, to prevent:

- Spillage of smoke, flame and carbon monoxide
- Spillage of sparks, coals, and logs
- Over firing

DO NOT leave the appliance unattended with the door open.

Starting a fire may not require an open door for draft.

5

ADD MORE WOOD

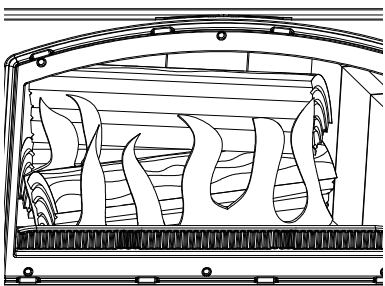

6

**ACTIVATE
Start-Up Air Control**

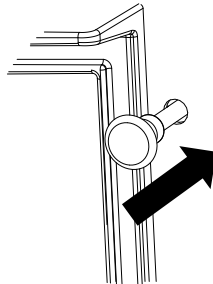

7

**The appliance is ready for
normal operation.**

1 Listing and Code Approvals

A. Insert Safety Certification

Model Number:	GIFFORD-CB & GIFFORD-BM
Laboratory:	PFS TECO
Report Number:	21-670
Type:	Solid Fuel Type, Listed Room Heater
Standard:	UL1482, ULC S628 and (UM) 84-HUD, Mobile Home Approved.

B. Insert Emissions Certification

Model Number:	GIFFORD-CB & GIFFORD-BM
Laboratory:	PFS TECO
Report Number:	21-661
Standard:	ASTM E2780-10

Can be found at:

www.forgenflame.com/pages/epa-certification

The GIFFORD-CB & GIFFORD-BM is Certified to comply with 2020 crib wood particulate emission standards.



This wood appliance needs periodic inspection and repair for proper operation. Consult the owner's manual for further information. It is against federal regulations to operate this wood appliance in a manner inconsistent with the operating instructions in the owner's manual.

NOTE: This installation must conform with local codes. In the absence of local codes you must comply with the **UL1482, (UM) 84-HUD and NPFA211 in the U.S.A. and the ULC S628-93 and CAN/CSA-B365 Installation Codes in Canada. NOT APPROVED FOR MOBILE HOME INSTALLATIONS IN CANADA!**

C. BTU & Efficiency Specifications

EPA Certification Number:	292-21
EPA Certified Emissions:	1.9 grams per hour
*LHV Tested Efficiency:	70%
**HHV Tested Efficiency:	65%
***EPA BTU Output:	23,800 to 27,400
****Peak BTU/Hour Output:	37,400
Vent Size:	6 inches
Firebox Size:	1.45 cubic feet
Recommended Log Length:	18 inches
Fuel	Seasoned Cord Wood

* Weighted average LHV (Low Heating Value) efficiency using Douglas Fir dimensional lumber and data collected during EPA emission tests in accordance with the requirements of CSA B415.1. LHV assumes the moisture is already in a vapor state so there is no loss in energy to vaporize.

** Weighted average HHV (High Heating Value) efficiency using Douglas Fir dimensional lumber and data collected during EPA emission tests in accordance with the requirements of CSA B415.1. HHV includes the energy required to vaporize the water in the fuel.

*** A range of BTU outputs calculated using HHV Efficiency and the burn rates from the EPA tests, using Douglas Fir dimensional lumber.

**** A peak BTU out of the appliance calculated using the maximum first hour burn rate from the High EPA Test and BTU content of seasoned cordwood (8600) times the efficiency.

D. Mobile Home Approved (USA only)

- This appliance is approved for mobile home installations when not installed in a sleeping room and when an outside combustion air inlet is provided.
- The structural integrity of the mobile home floor, ceiling, and walls must be maintained.
- The appliance must be properly grounded to the frame of the mobile home with #8 copper ground wire, and chimney must be listed to UL103 HT or a listed UL-1777 full length six inch (152mm) diameter liner must be used.
- Outside Air Kit, part OAK-ACC must be installed in a mobile home installation.

E. Glass Specifications

This appliance is equipped with 5mm ceramic glass. Replace glass only with 5mm ceramic glass. Please contact your dealer for replacement glass.

F. Sleeping Room

When installed in a sleeping room it is recommended that a smoke and/or CO alarm be installed in the bedroom. The size of the room must be at least 50ft³ per 1,000 Btu/hr stove input, if the stove exceeds the room size, outside air must be installed.

G. California - Prop65

WARNING

This product and the fuels used to operate this product (wood), and the products of combustion of such fuels, can expose you to chemicals including carbon black, which is known to the State of California to cause cancer, and carbon monoxide, which is known to the State of California to cause birth defects or other reproductive harm. For more information go to: WWW.P65Warnings.ca.gov



WARNING



Fire Risk.

Hearth & Home Technologies disclaims any responsibility for, and the warranty will be voided by, the following actions:

- Installation and use of any damaged appliance.
- Modification of the appliance.
- Installation other than as instructed by Hearth & Home Technologies.
- Installation and/or use of any component part not approved by Hearth & Home Technologies.
- Operating appliance without fully assembling all components.
- Operating appliance without legs attached (if supplied with unit).
- Do NOT Over fire - If appliance or chimney connector glows, you are over firing.

Any such action that may cause a fire hazard.

Improper installation, adjustment, alteration, service or maintenance can cause injury or property damage.

For assistance or additional information, consult a qualified installer, service agency or your dealer.

Hearth & Home Technologies WILL NOT warranty stoves that exhibit evidence of over-firing. Evidence of over-firing includes, but is not limited to:

- Warped air tube
- Deteriorated refractory brick retainers
- Deteriorated baffle and other interior components

NOTE: Hearth & Home Technologies, manufacturer of this appliance, reserves the right to alter its products, their specifications and/or price without notice.

2 Operating Instructions

WARNING



HOT SURFACES!

Glass and other surfaces are hot during operation AND cool down.

Hot glass will cause burns.

- Do not touch glass until it is cooled
- NEVER allow children to touch glass
- Keep children away
- CAREFULLY SUPERVISE children in same room as appliance.
- Alert children and adults to hazards of high temperatures.
- High temperatures may ignite clothing or other flammable materials.
- Keep clothing, furniture, draperies and other flammable materials away.

A. Your Wood Appliance

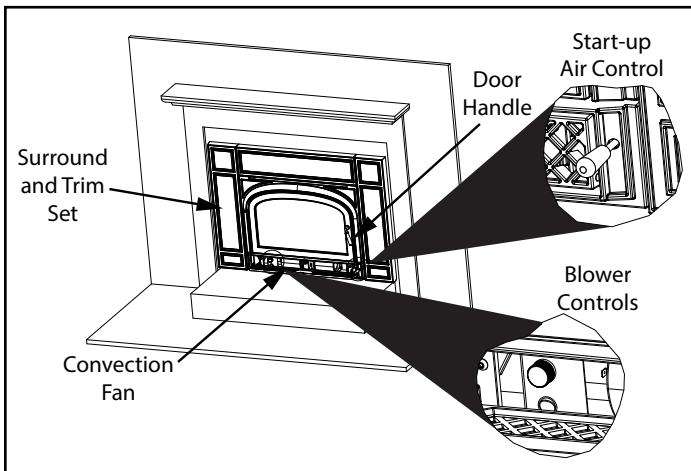

Figure 9.1 - General Operating Parts

WARNING



Do not operate appliance before reading and understanding operating instructions. Failure to operate appliance according to operating instructions could cause fire or injury.

B. Fire Safety

To provide reasonable fire safety, the following should be given serious consideration:

1. Install at least one smoke detector on each floor of your home to ensure your safety. They should be located away from the heating appliance and close to the sleeping areas. Follow the smoke detector manufacturer's placement and installation instructions, and be sure to maintain regularly.
2. A conveniently located Class A fire extinguisher to contend with small fires resulting from burning embers.
3. A CO detector should be installed in the room with the appliance.
4. A practiced evacuation plan, consisting of at least two escape routes.
5. A plan to deal with a chimney fire as follows:
 - In the event of a chimney fire:
 - Evacuate the house immediately
 - Notify fire department.

C. Over firing

WARNING



Fire Risk. Do not over-fire.

Over-firing may ignite creosote or will damage the appliance and chimney.

To prevent over-firing your appliance, DO NOT:

- Use flammable liquids.
- Overload with wood.
- Burn trash or large amounts of scrap lumber.
- Permit too much air to the fire.

1. Symptoms of Over-Firing

Symptoms of over-firing may include one or more of the following:

- Chimney connector or appliance glowing.
- Roaring, rumbling noises.
- Loud cracking or banging sounds.
- Metal warping.
- Chimney fire.

2. What To Do if Your Appliance is Over-Firing

- Immediately close the door and air controls to reduce air supply to the fire.
- If you suspect a chimney fire, call the fire department and evacuate your house.
- Contact your local chimney professional and have your appliance and appliance pipe inspected for any damage.
- Do not use your stove until the chimney professional informs you it is safe to do so.

Hearth & Home Technologies WILL NOT warranty stoves that exhibit evidence of over-firing. Evidence of over-firing includes, but is not limited to:

- Warped air tube
- Deteriorated refractory brick retainers
- Deteriorated baffle and other interior components

D. Combustible/Non-combustible Materials

- **Combustible Material** - Material made of or surfaced with wood, compressed paper, plant fibers, plastics, or any material capable of igniting and burning, whether flame-proofed or not, plastered or non-plastered.
- **Non-combustible Material** - Material which will not ignite and burn. Such materials are those consisting entirely of steel, iron, brick, tile, slate, glass or plasters, or any combination thereof.
- **Non-combustible Sealant Material** - Sealants which will not ignite and burn: Rutland, Inc. Fireplace Mortar #63, Rutland 76R, Nuflex 304, GE RTV106 or GE RTB116 (or equivalent).

E. Seasoned Wood

Burn only dry seasoned wood. Store wood under cover, out of the rain and snow. Dry and well-seasoned wood will not only minimize the chance of creosote formation, but will give you the most efficient fire. Even dry wood contains at least 15% moisture by weight, and should be burned hot enough to keep the chimney hot for as long as it takes to dry the wood out - about one hour. It is a waste of energy to burn unseasoned wood of any kind.

Dead wood lying on the forest floor should be considered wet, and requires full seasoning time. Standing dead wood can be considered to be about 2/3 seasoned. To tell if wood is dry enough to burn, check the ends of the logs. If there are cracks radiating in all directions from the center, it is dry. If your wood sizzles in the fire, even though the surface is dry, it may not be fully cured.

Splitting wood before it is stored reduces drying time. Wood should be stacked so that both ends of each piece are exposed to air, since more drying occurs through the cut ends than the sides. This is true even with wood that has been split. Store wood under cover, such as in a shed, or covered with a tarp, plastic, tar paper, sheets of scrap plywood, etc., as uncovered wood can absorb water from rain or snow, delaying the seasoning process.

F. Burning Process

In recent years there has been an increasing concern about air quality. Much of the blame for poor air quality has been placed on the burning of wood for home heating. In order to improve the situation, we at Vermont Castings have developed cleaner-burning wood appliances that surpass the requirements for emissions established by our governing agencies. These wood appliances must be properly operated in order to ensure that they perform the way they are designed to perform.

NOTICE: Improper operation can turn any wood appliance into a smoldering environmental hazard.

1. **Kindling or First Stage** - It helps to know a little about the actual process of burning in order to understand what goes on inside a appliance. The first stage of burning is called the kindling stage. In this stage, the wood is heated to a temperature high enough to evaporate the moisture which is present in all wood. The wood will reach the boiling point of water (212°F) and will not get any hotter until the water is evaporated. This process takes heat from the coals and tends to cool the appliance.

Fire requires three things to burn - fuel, air and heat. So, if heat is robbed from the appliance during the drying stage, the new load of wood has reduced the chances for a good clean burn. For this reason, it is always best to burn dry, seasoned firewood. The heat generated from the fire should be warming your home and establishing the flue draft, not evaporating the moisture out of wet, unseasoned wood, resulting in wasted heat.
2. **Second Stage** - The next stage of burning, the secondary stage, is the period when the wood gives off flammable gases which burn above the fuel with bright flames. During this stage of burning it is very important that the flames be maintained and not allowed to go out. This will ensure the cleanest possible fire.

3. **Final Stage** - The final stage of burning is the charcoal stage. This occurs when the flammable gases have been mostly burned and only charcoal remains. This is a naturally clean portion of the burn. The coals burn with hot blue flames.

It is very important to reload your appliance while enough lively hot coals remain in order to provide the amount of heat needed to dry and rekindle the next load of wood. It is best to activate the ACC before reloading (**Figure 11.1**). This livens up the coal bed and reduces excessive emissions (opacity/smoke). Open door slowly so that ash or smoke does not exit appliance through opening. You should also break up any large chunks and distribute the coals so that the new wood is laid on hot coals.

Air quality is important to all of us, and if we choose to use wood to heat our homes we should do so responsibly. To do this we need to learn to burn our appliances in the cleanest way possible. Doing this will allow us to continue using our wood appliances for many years to come.

G. Start-Up Air Control

When using the start-up air control system, you do not have to continually monitor the fire. Once you set the start-up air control system it will control the fire for you. Follow the instructions below to learn how to operate your appliance with ease.

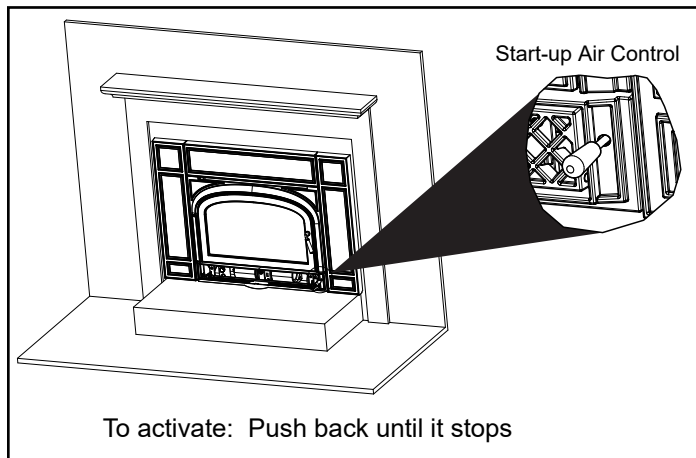



Figure 11.1

H. Burn Rate and Operating Efficiency

 WARNING	
	This wood appliance has a manufacturer-set minimum low burn rate that must not be altered. It is against federal regulations to alter this setting or otherwise operate this wood insert in a manner inconsistent with operating instructions in this manual.

For maximum operating efficiency

- Burn dry, well-seasoned wood.
- Follow these burn rate instructions below.

Burn Rate

1. Starting a Fire:

- Load appliance with wood and start fire (reference **Quick Start Guide** on [page 6](#)).
- Activate ACC.



2. Reloading:

- Add wood as needed.
- Activate ACC.

3. **Adjusting the Burn Rate** - This wood appliance is designed to optimize efficiency at all times. Since there are no user controls to adjust the burn rate, the easiest method is to learn how many logs you need at a time for the amount of heat desired. In addition to the amount of wood and the size of the logs, take the time to experiment with split and unsplit logs as split logs will burn faster than unsplit logs.

NOTE: If using the blower, it should be off for the first 30 minutes and then be operated in the desired setting at 30 minutes.

I. Wood Fuel

 WARNING	
	Fire Risk. <ul style="list-style-type: none"> • DO NOT BURN GARBAGE OR FLAMMABLE FLUIDS SUCH AS GASOLINE, NAPHTHA OR ENGINE OIL. • Do NOT burn treated wood or wood with salt (driftwood).
	<ul style="list-style-type: none"> • May generate carbon monoxide if burn material other than wood. <p>May result in illness or possible death.</p>

Hardwood vs Softwood

Your appliance performance depends on the quality of the firewood you use.



- Seasoned wood contains about 8,000 BTUs per pound.
- Hard woods are more dense than soft woods.
- Hard woods contain 60% more BTUs than soft woods.
- Hard woods require more time to season, burn slower and are harder to ignite.
- Soft woods require less time to dry, burn faster and are easier to ignite.
- Start the fire with softwood to bring the appliance up to operating temperature and to establish draft.
- Add hardwood for slow, even heat and longer burn time.

HARDWOODS	SOFTWOODS
Alder	Aspen
Apple	Cedar
Birch	Douglas Fir
Maple	Pine
Oak	Spruce
Poplar	

Processed Solid Fuel Fire Logs

- NOT permitted for use in this appliance

Moisture

 WARNING	
	Fire Risk. <ul style="list-style-type: none"> • Do NOT burn wet or green wood. • Store wood in dry location. • Stack wood so both ends are exposed to air.
	<p>Wet, unseasoned wood can cause accumulation of creosote.</p>

The majority of the problems appliance owners experience are caused by trying to burn wet, unseasoned wood.

- Wet, unseasoned wood requires energy to evaporate the water instead of heating your home, and
- Causes evaporating moisture which cools your chimney, accelerating formation of creosote.

Seasoned Wood



- Cut logs to size
- Split to 6 inches (152 mm) or less in diameter
- Air dry to a moisture content of not more than 20%
 - Softwood - about nine months to dry
 - Hardwood - about eighteen months to dry

NOTICE: Seasoning time may vary depending on drying conditions.

Storing Wood

Steps to ensure properly seasoned wood:

- Stack wood to allow air to circulate freely around and through woodpile.
- Elevate wood pile off ground to allow air circulation underneath.
- Smaller pieces of wood dry faster. Any piece over 6 in. (152 mm) in diameter should be split.
- Wood (whole or split) should be stacked so both ends of each piece are exposed to air. More drying occurs through the cut ends than the sides.
- Store wood under cover to prevent water absorption from rain or snow. Avoid covering the sides and ends completely.

 WARNING	
	Fire Risk Do NOT store wood:
	<ul style="list-style-type: none"> • In front of the appliance. • In space required for loading or ash removal.

J. Building A Fire

Before lighting your first fire in the appliance:

NOTE: The special high temperature paint that your appliance is finished with will cure as your appliance heats. You will notice an odor and perhaps see some vapor rise from the appliance surface; this is normal. We recommend that you open a window until the odor dissipates and paint is cured.

1. Confirm the baffle and ceramic blanket are correctly positioned. They should be touching back of firebox and secured into Baffle Protection Channel (**Figure 13.1**).
2. Remove all labels from glass.

There are many ways to build a fire. The basic principle is to light easily-ignitable tinder or paper, which ignites the fast burning kindling, which in turn ignites the slow-burning firewood.

Here is one method that works well:

1. Activate ACC.
2. Place several wads of crushed paper on the firebox floor. Heating the flue with slightly crumpled newspaper before adding kindling keeps smoke to a minimum.
3. Lay small dry sticks of kindling on top of the paper.
4. Make sure that no matches or other combustibles are in the immediate area of the appliance. Be sure the room is ventilated and the flue unobstructed.
5. Light the paper in the appliance. NEVER light or rekindle fire with kerosene, gasoline, or charcoal lighter fluid; the results can be fatal.
6. Once the kindling is burning quickly, add several full-length logs 3 to 4 inches (76 - 102mm) in diameter. Be careful not to smother the fire. Stack the pieces of wood 1/2 to 1 inch apart (13-25mm); near enough to keep each other hot, but far enough away from each other to allow air flow between them.
7. Activate the timer system (ACC).
 - This livens up the coal bed and reduces excessive emissions (opacity/smoke).
 - Open door slowly so that ash or smoke does not exit appliance through opening.
 - Large logs burn slowly, holding a fire longer.
 - Small logs burn fast and hot, giving quick heat.
8. As long as there are hot coals, repeating steps 6 through 7 will maintain a continuous fire.

Fuel reloading:

1. **This appliance has a large door with an exceptional view of the fire.**
 - Opens to about 90 degrees and has a built-in stop.
 - Door opens 26 inches (660mm) which goes beyond the standard size hearth pad covering the floor in front of the appliance.
 - May want to use a hearth rug in front of the hearth pad to protect the flooring from ash spillage and continuous cleaning of carpet, etc.
2. **Open door slowly so that ash or smoke does not exit appliance through opening.**
 - Check the level of the ash build-up. Remove ash if it reaches the top of the brick covers. Ash should not be spilling over the brick covers onto the ash lip.
 - Any ash or coals on the ash lip can be pressed into the door gasket and shorten the life of the gasket.
 - If the ash is left to accumulate on the ash lip it can interfere with the door closing and/or falling out onto the hearth pad or beyond.

Check the ash level each time you reload.

NOTE: Build fire on brick firebox floor. Do NOT use grates, andirons or other methods to support fuel. It will adversely affect emissions.

 **WARNING**

 **Fire Risk.**
Do NOT store wood:

- Closer than required clearances to combustibles to appliance
- Within space required for loading or ash removal.

Do NOT operate appliance:

- With appliance door open.
- With ash removal system door open.

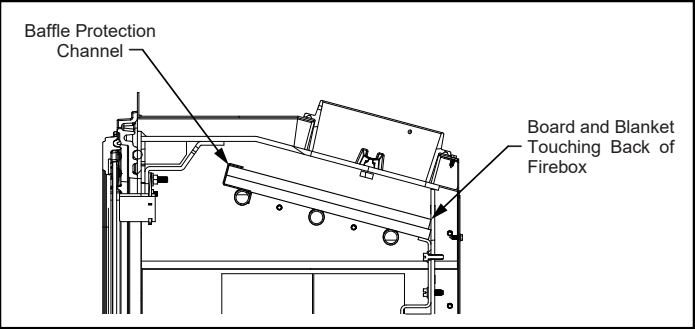



Figure 13.1

 **WARNING**

 **Fire Risk.**

- Do NOT burn wet or green wood.
- Store wood in dry location.
- Stack wood so both ends are exposed to air.

Wet, unseasoned wood can cause accumulation of creosote.

K. Blower Control Box with Snap Disc

1. The blower will turn on/off automatically when set to AUTO (**Figure 14.1**).
2. When set to MANUAL, the fan will turn on/off only when you turn it on or off. This setting over-rides the internal snap disc.
3. Adjust the speed of the fan by turning the HIGH/LOW knob to the desired setting.

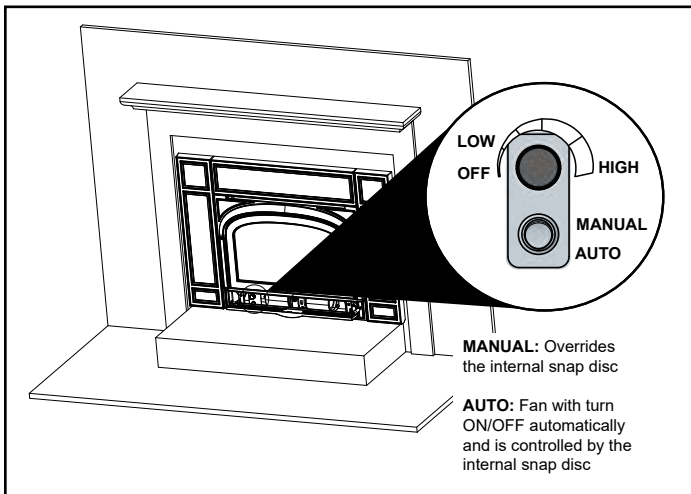

Figure 14.1

L. Blower Operation

1. **Initial (cold) startup** - Push the Start-up Air Control back until it stops. The blower tends to cool the appliance. Leave the blower off until the burn is well established, i.e., 30 minutes.

NOTE: For maximum efficiency and lowest emissions, when operating the blower in either the automatic or manual setting for the blower off until the burn is well established, i.e., 30 minutes.

2. The blower is equipped with five setting switch. Increase blower speed by turning the setting knob clockwise.

M. Opacity (Smoke)

Opacity is the measure of how cleanly your appliance is burning. Opacity is measured in percent; 100% opacity is when an object is totally obscured by the smoke column from a chimney, and 0% opacity means that no smoke column can be seen. As you become familiar with your appliance, you should periodically check the opacity. This will allow you to know how to burn as nearly smoke-free as possible (goal of 0% opacity).



CAUTION

When burning your first fire, you will experience smoke and odor from the appliance resulting from the curing of paint and burning off of any oils remaining from manufacturing.

Open windows during initial burn to dissipate smoke and odors!

- Odors may be irritating to sensitive individuals.
- Smoke detectors may activate.

NOTICE: Do NOT operate a circulating fan within close proximity, approximately 4 ft (1.2m), of appliance. Can reverse air flow, blowing hot air into appliance cavity. Can damage appliance blower due to overheating.

N. Clear Space

- Do NOT place combustible objects within 4 ft (1.2 m) of the front of appliance (**Figure 14.2**).
- **Mantel** - Avoid placing candles and other heat-sensitive objects on mantel or hearth. Heat may damage these objects.



WARNING

Do NOT place combustible objects in front of the appliance. High temperatures may ignite clothing, furniture or draperies.

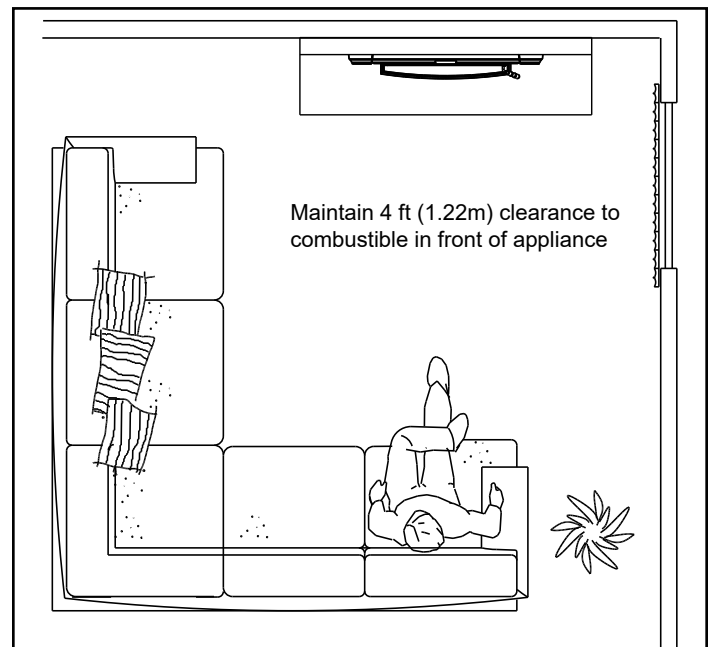



Figure 14.2

O. Negative Pressure

 WARNING	
	Asphyxiation Risk.
	<ul style="list-style-type: none"> Negative pressure can cause spillage of combustion fumes, soot and carbon monoxide. Appliance needs to draft properly for safety.

Negative pressure results from the imbalance of air available for the appliance to operate properly. It can be strongest in lower levels of the house.

Causes include:

- Exhaust fans (kitchen, bath, etc.).
- Range hoods.
- Combustion air requirements for furnaces, water appliances and other combustion appliances
- Clothes dryers.
- Location of return-air vents to furnace or air conditioning.
- Imbalances of the HVAC air handling system
- Upper level air leaks such as:
 - Recessed lighting
 - Attic hatch
 - Duct leaks

To minimize the effects of negative air pressure:



- Install the outside air kit with the intake facing prevailing winds during the heating season
- Ensure adequate outdoor air for all combustion appliances and exhaust equipment
- Ensure furnace and air conditioning return vents are not located in the immediate vicinity of the appliance
- Avoid installing the appliance near doors, walkways or small isolated spaces
- Recessed lighting should be a “sealed can” design
- Attic hatches weather stripped or sealed
- Attic mounted duct work and air handler joints and seams taped or sealed



 CAUTION	
Do NOT operate a circulating fan within close proximity, approximately 4 ft (1.2m), of appliance:	
<ul style="list-style-type: none"> Can reverse air flow, blowing hot air into appliance cavity. Can damage appliance blower due to overheating. 	

P. Frequently Asked Questions

ISSUES	SOLUTIONS
Odor from appliance	When first operated, this appliance may release an odor for the first several hours. This is caused by the curing of the paint and the burning off of any oils remaining from manufacturing.
Metallic noise	Noise is caused by metal expanding and contracting as it heats up and cools down, similar to the sound produced by a furnace or heating duct. This noise does not affect the operation or longevity of the appliance.
Whirring sound	If the blower has been installed, the blower produces a whirring sound which increases in volume as the speed is increased.
CONTACT YOUR DEALER for additional information regarding operation and troubleshooting. Visit www.forgenflame.com to find a dealer.	

Table 15.1

 WARNING	
	Fire Risk.
	<ul style="list-style-type: none"> DO NOT BURN GARBAGE OR FLAMMABLE FLUIDS SUCH AS GASOLINE, NAPHTHA OR ENGINE OIL. Do NOT burn treated wood or wood with salt (driftwood). <p>• May generate carbon monoxide if burn material other than wood.</p> <p>May result in illness or possible death.</p>

 WARNING	
	Fire Risk.
	<p>Keep combustible materials, gasoline and other flammable vapors and liquids clear of appliance.</p> <ul style="list-style-type: none"> Do NOT store flammable materials in the appliance’s vicinity. <ul style="list-style-type: none"> DO NOT USE GASOLINE, LANTERN FUEL, KEROSENE, CHARCOAL LIGHTER FLUID OR SIMILAR LIQUIDS TO START OR “FRESHEN UP” A FIRE IN THIS APPLIANCE. Keep all such liquids well away from the appliance while it is in use. Combustible materials may ignite.

3 Maintenance and Service

A. Quick Reference Maintenance Guide

When properly maintained, your appliance will give you many years of trouble-free service. Contact your dealer to answer questions regarding proper operation, troubleshooting and service for your appliance. Visit www.forgenflame.com/pages/quadra-fire-owner-resources to view basic troubleshooting, FAQs, use & care videos.



CAUTION

Allow the appliance to completely cool down before performing any cleaning or maintenance. Start the first inspection after the first 2 months of use, or if performance changes, and adjust your schedule accordingly. Maintenance is required for safe operation and must be performed to maintain your warranty.

	FREQUENCY	TASK
<p>Baffle & Blanket</p>	<p>MONTHLY or after every one (1) cord of wood</p>	<p>Baffle and blanket placement is critical to heat output, efficiency and overall life of the appliance. Make sure the baffle is pushed all of the way to the back of the firebox and the blanket is laying flat. Inspect baffle for cracks.</p>
<p>Blower</p>	<p>YEARLY or after every four (4) cords of wood</p>	<p>Vacuum the blower impellers.</p>
<p>Chimney System</p>	<p>EVERY TWO MONTHS or after every four (4) cords of wood</p>	<p>The chimney and chimney cap must be inspected for soot and creosote every two months during the burn season or more frequency if chimney exceeds or is under 14-16 ft (4.3m-4.8m) measured from bottom of appliance.</p> <p>This will prevent pipe blockage, poor draft, and chimney fires. Always burn dry wood to help prevent cap blockage and creosote build-up.</p>
<p>Firebrick & Ash Removal</p>	<p>WEEKLY or after every 25 loads of wood</p>	<p>Ashes must be cool before you can dispose of the ashes in a non-combustible container.</p> <p>Firebrick is designed to protect your firebox. After ashes are removed, inspect the firebrick and replace firebricks that are crumbling, cracked or broken.</p>
<p>Door & Glass Assemblies</p>	<p>WEEKLY or after every 25 loads of wood</p>	<p>Keep door and glass gasket in good shape to maintain good burn. <u>To test:</u> place a dollar bill between the appliance and door and then shut the door. If you can pull the dollar out, remove one washer from door handle behind latch cam and try again. If you can still pull it out, replace the door gasket.</p> <p>Check the glass frame for loose screws to prevent air leakage.</p> <p>Check glass for cracks.</p>
<p>Door Handles</p>	<p>WEEKLY or after every 25 loads of wood</p>	<p>Check the door latch for proper adjustment. This is very important especially after the door rope has formed to the appliance face.</p> <p>Check door handle for smooth cam operation.</p>

These are generic drawings and may not represent your model.

Table 16.1

B. Cleaning the Glass & Replacement

Most of the carbon deposits on the glass will burn off during hot fires.

However, the ash residue that accumulates on the glass surface should be removed regularly to prevent etching. To clean the glass, follow this procedure:

- Be sure the glass is completely cool.
- Clean the glass with water or a cleaner made especially for this purpose. Do not use abrasive cleaners. Use cleaning agents sparingly and be sure to keep them off the outer surfaces of the stove.
- Rinse the glass thoroughly.
- Dry the glass completely.

Replace Broken Glass Immediately

Do not operate your stove if the glass in the doors is damaged.

If you need to replace the glass, use only the high temperature 5 mm ceramic glass supplied by Vermont Castings. Do not use substitutes.

Service Part: SRV7094-054

1. Ensure that the fire is out and the appliance is cool to the touch.
2. Protect a table or counter top with padding or towels. Protect your hands and wear gloves to prevent injury.
3. Remove the door with the broken glass by lifting the door up and off of the hinges.
4. Lay door face down on a table or counter making sure the handle hangs over the edge so the door lays flat, on a soft surface.
5. Remove the screws from each glass retainer and remove the glass. (If screws are difficult to remove, soak with penetrating oil first).
6. Center the glass with edges evenly overlapping the opening in the door, (i.e. same space top and bottom, left and right sides).
7. Replace the glass retainers. Be careful not to cross thread the screws.
8. Tighten each retainer just a few turns until each is secured. Check again for centering of glass in door frame. Continue to tighten each retainer alternately, a few turns at a time, until the glass is secure.

NOTE: DO NOT OVER TIGHTEN RETAINERS - can cause glass to break.

9. Replace the door on the appliance.

Vermont Castings appliances are equipped with ceramic super heat-resistant glass, which can only be broken by impact or misuse.



WARNING



Injury Risk.

- Use only glass specified in manual.
- DO NOT REPLACE with any other material.



CAUTION

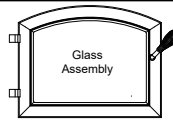

Handle glass assembly with care.
When cleaning glass:

- Avoid striking, scratching or slamming glass.
- Do NOT clean glass when hot.
- Do NOT use abrasive cleaners.
- Use a hard water deposit glass cleaner on white film.
- Use commercial oven cleaner on heavier deposits.
- Remove all residue of oven cleaner or will permanently stain glass on next firing.

Refer to maintenance instructions.

C. General Maintenance

1. Creosote (Chimney) Cleaning

- **Frequency:** Every 2 months during heating season or as recommended by a certified chimney sweep; more frequently if chimney exceeds or is under 14-16 ft. (measured from bottom of appliance)
- **By:** Certified Chimney Sweep

Remove all ash from the firebox and extinguish all hot embers before disposal. Allow the appliance to cool completely. Disconnect flue pipe or remove baffle and ceramic blanket from appliance before cleaning chimney. Otherwise residue can pile up on top of the baffle and ceramic blanket and the appliance will not work properly. Close the door tightly. The creosote or soot should be removed with a brush specifically designed for the type of chimney in use. Clean out fallen ashes from the firebox.



It is also recommended that before each heating season the entire system be professionally inspected, cleaned and repaired, if necessary.



Inspection - Inspect the system at the appliance connection and at the chimney top. Cooler surfaces tend to build creosote deposits quicker, so it is important to check the chimney from the top as well as from the bottom.

Formation and Need For Removal - When wood is burned slowly, it produces tar and other organic vapors which combine with expelled moisture to form creosote.

The creosote vapors condense in the relatively cool chimney flue of a newly-started or a slow-burning fire. As a result, creosote residue accumulates on the flue lining. When ignited, this creosote creates an extremely hot fire which may damage the chimney or even destroy the house.

The chimney connector and chimney should be inspected once every 2 months during the heating season to determine if a creosote or soot buildup has occurred. If creosote or soot has accumulated, it should be removed to reduce the risk of a chimney fire.

 WARNING	
	Fire Risk. Prevent creosote buildup.
	<ul style="list-style-type: none"> • Inspect chimney connector and chimney once every two months during heating season. • Remove creosote to reduce risk of chimney fire. • Ignited creosote is extremely HOT.



 WARNING	
	Fire Risk.
	<ul style="list-style-type: none"> • Do not use chimney cleaners or flame colorants in your appliance. Will corrode chimney pipe.

2. Disposal of Ashes

- **Frequency:** When ash is within 1-3/4 in. (44mm) of firebox lip
- **By:** Homeowner

 WARNING	
	Fire Risk.
	Ashes could contain hot embers.

Ashes should be placed in a metal container with a tight fitting lid. The closed container of ashes should be placed on a non-combustible floor or on the ground, well away from all combustible materials, pending final disposal. If the ashes are disposed of by burial in soil or otherwise locally dispersed, they should be retained in the closed container until all cinders have thoroughly cooled.

 WARNING	
	Fire Risk. Disposal of Ashes
	<ul style="list-style-type: none"> • Ashes should be placed in metal container with tight fitting lid. • Do not place metal container on combustible surface.
	<ul style="list-style-type: none"> • Ashes should be retained in closed container until all cinders have thoroughly cooled.

3. Appliance Inspection

- **Frequency:** Every 2 months at the same time the chimney and chimney connector are inspected.
- **By:** Homeowner

Check for:

- Cracks in glass
- Door handle - smooth cam operation
- Baffle and ceramic blanket correct placement
- Baffle for warp-age
- Firebrick for cracks, broken or crumbly
- Door gasket (Dollar bill test): Place a dollar bill between the stove and the door and then shut the door. If you can pull the dollar bill out, replace the door gasket.
- Glass frame for loose screws

4. Glass Cleaning

- **Frequency:** As desired
- **By:** Homeowner

 CAUTION	
Handle glass assembly with care. Glass is breakable.	
<ul style="list-style-type: none"> • Avoid striking, scratching or slamming glass • Avoid abrasive cleaners • Do not clean glass while it is hot 	

Clean glass with a non-abrasive glass cleaner. Abrasive cleaners may scratch and cause glass to crack. If the deposits on the glass are not very heavy, normal glass cleaners work well. Heavier deposits may be removed by using a damp cloth dipped in wood ashes or by using a commercially available oven cleaner.

After using an oven cleaner, it is advisable to remove any residue with a glass cleaner or soap and water. Oven cleaner left on during the next firing can permanently stain the glass and damage the finish on metal surfaces.

A portion of the combustion air entering the firebox is deflected down over the inside of the door glass. This air flow "washes" the glass, helping to keep smoke from adhering to its surface.

5. Cleaning Plated Surfaces

- **Frequency:** Prior to first burn and then as desired
- **By:** Homeowner

 CAUTION	
Do not use polishes with abrasives. It will scratch plated surfaces.	

Clean all the fingerprints and oils from plated surfaces **BEFORE** firing the appliance for the first time. If not cleaned properly before lighting your first fire, the oils can cause permanent markings on the plating.

After the plating is cured, the oils will not affect the finish and little maintenance is required. Wipe clean as needed.

6. Inspect Firebrick



- **Frequency:** After each ash removal
- **By:** Homeowner

Replace the firebrick if they become crumbly and/or if there is a 1/4 inch (6.35mm) gap between the bricks.

The firebox is lined with firebrick, which has exceptional insulating properties. Do not use a grate; simply build a fire on the firebox floor. Do not operate appliance without firebrick.

1. After the coals have completely cooled, remove all old brick and ash from unit and vacuum firebox.
2. Remove new brick set from box and lay out to the diagram shown in the instructions that come with the brick set or refer to the diagram on the service parts list at the end of this manual.
3. Lay bottom bricks in unit.
4. Install rear bricks on the top of the bottom bricks. Slide top of bricks under clip on back of firebox wall and push bottom of bricks back.
5. Install side bricks. Slide top of brick under clips on side of firebox and push the bottom of the brick until it is flush with the side of the unit.

D. Correct Baffle & Blanket Placement

	WARNING
	<p>Fire Risk. Firebox damage due to improper baffle placement is not covered by warranty. Operate the wood burning appliance with the baffle in the correct position only.</p> <p><u>Not doing so could result in:</u></p> <ul style="list-style-type: none"> • Reduced efficiency • Overheating the chimney • Overheating the rear of the firebox • Poor performance <p>Ensure correct baffle placement and replace baffle components if damaged or missing.</p>

	CAUTION
<p>The baffle boards are FRAGILE. Use extreme caution when loading firewood to prevent:</p> <ul style="list-style-type: none"> • Cracking, breaking or damaging the baffle boards <p>DO NOT operate the appliance without baffle boards</p>	

NOTE: A missing, damaged or improperly positioned baffle is dangerous and may cause damage and poor efficiency. It will also void your warranty.

NOTE: These are generic drawings and may not represent your specific model.

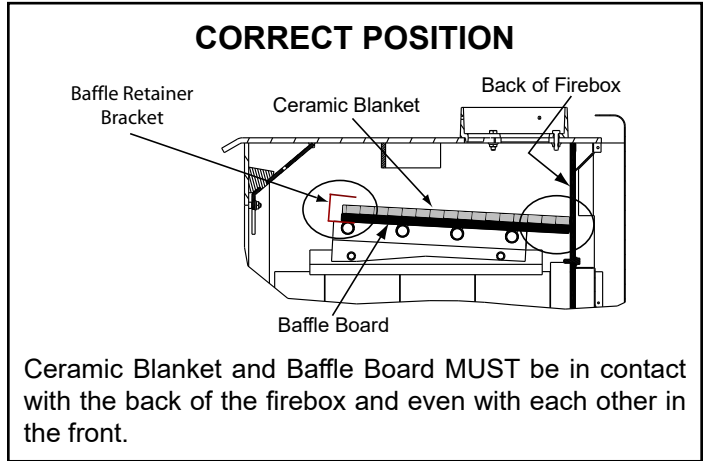

Figure 19.1 - Correct Baffle and Blanket Positions

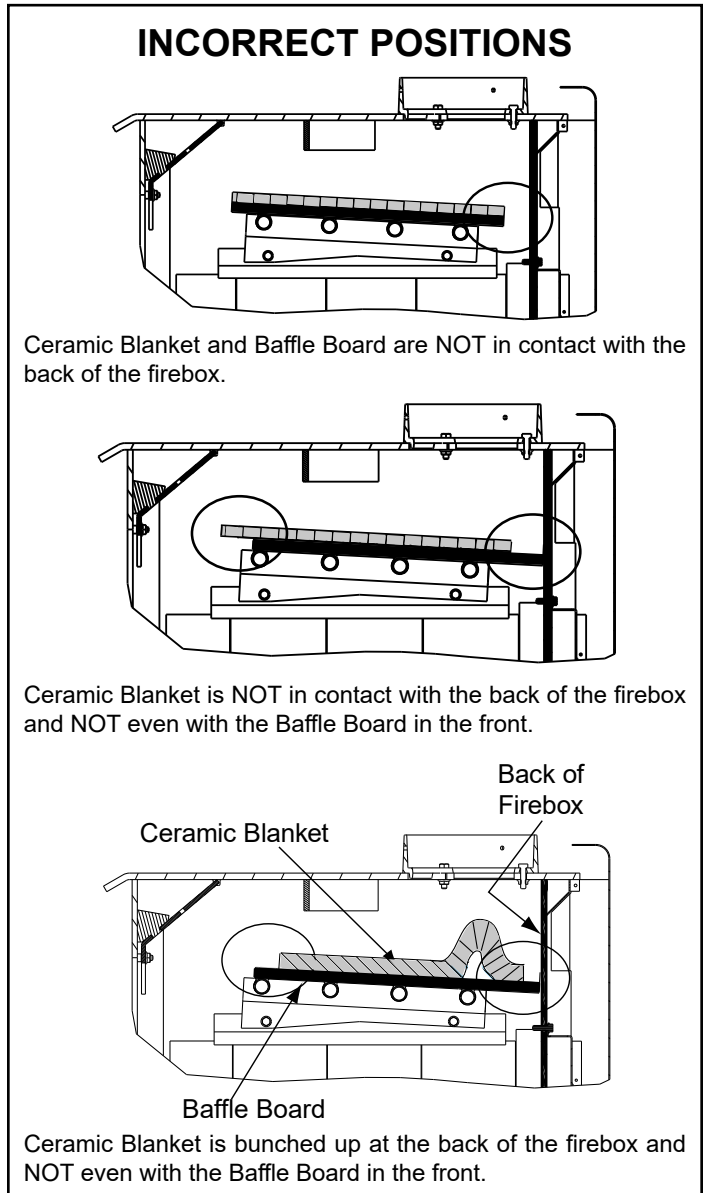

Figure 19.2 - Incorrect Baffle and Blanket Positions

E. Baffle Board Replacement

Service Part: SRV7095-117

1. Remove all ash from the firebox, and extinguish all hot embers before disposal into a metal container.
2. It is easier to remove both baffle boards and ceramic blanket after the tubes have been partially disassembled and the right side lowered. Follow steps 1 through 4 on page 21 for removal of the tubes. It is not necessary to completely remove the tubes.
3. Once the baffle protection cover has been removed, pull the baffle boards and ceramic blanket forward about 1 inch (25mm) and then overlap the baffles about 1-2 inches (25-51mm) (**Figure 20.1**).
4. Slide the tubes to the left as far as it will go and lower the right side. Remove the baffle boards and ceramic blanket together (**Figure 20.2**).
5. Re-install in reverse order. Be sure the baffle boards and ceramic blanket are in their proper positions (Reference **Correct Baffle & Blanket Placement** on [page 19](#)).

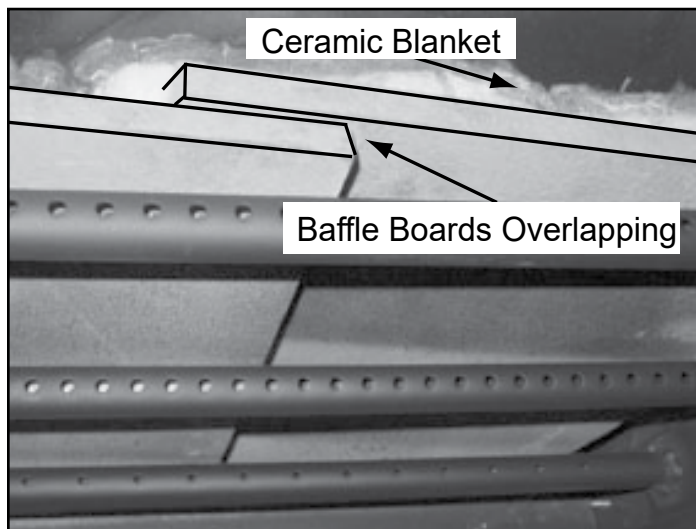

Figure 20.1

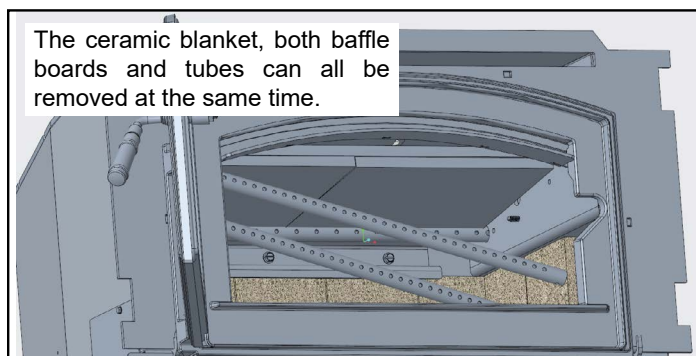

Figure 20.2

F. Tube Replacement

Service Part: SRV7094-121 (Front, Middle Tube)
SRV7094-123 (Rear Tube)

Removing Tube Channel Assembly

1. Remove the 3 right side bricks.
2. Remove the baffle protection channel by bending back the tabs using needle nose pliers located at the right and left side of the protection cover. Lift the cover up slightly and pull toward the front and out of the firebox (**Figure 20.3**).
3. Locate the 2 bolts inside of chamber and remove using a 3/8 socket wrench (**Figure 20.4**).
4. Once bolts are removed remove tube support.

NOTE: Soak the bolts with penetrating oil for at least 15 minutes before trying to remove them.

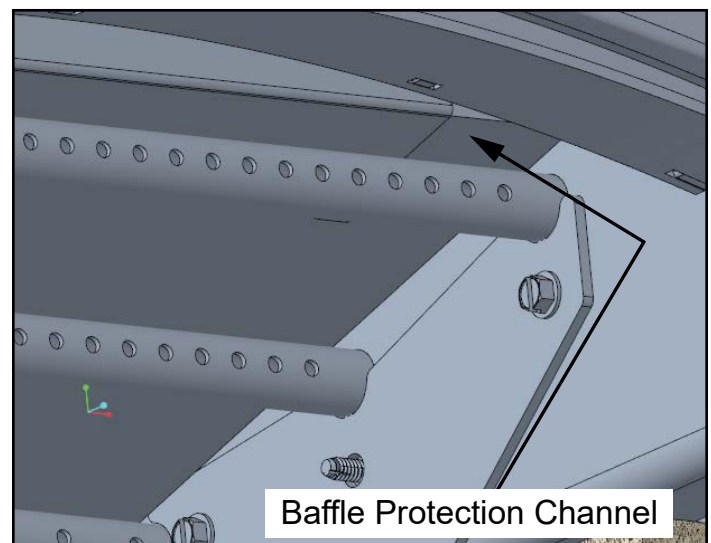

Figure 20.3

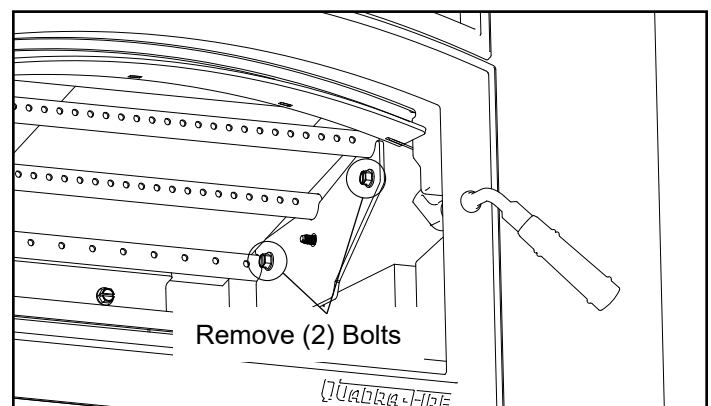

Figure 20.4

4. Slide tubes all the way to left. Drop the right side down, then slide the tube back to right (**Figure 21.1**).
5. The ceramic blanket and both baffle boards can be removed at the same time you remove the tubes.
6. When the tubes are free of the left side support, rotate clockwise and pull, blanket and baffles out through the front opening.
7. Re-install in reverse order.

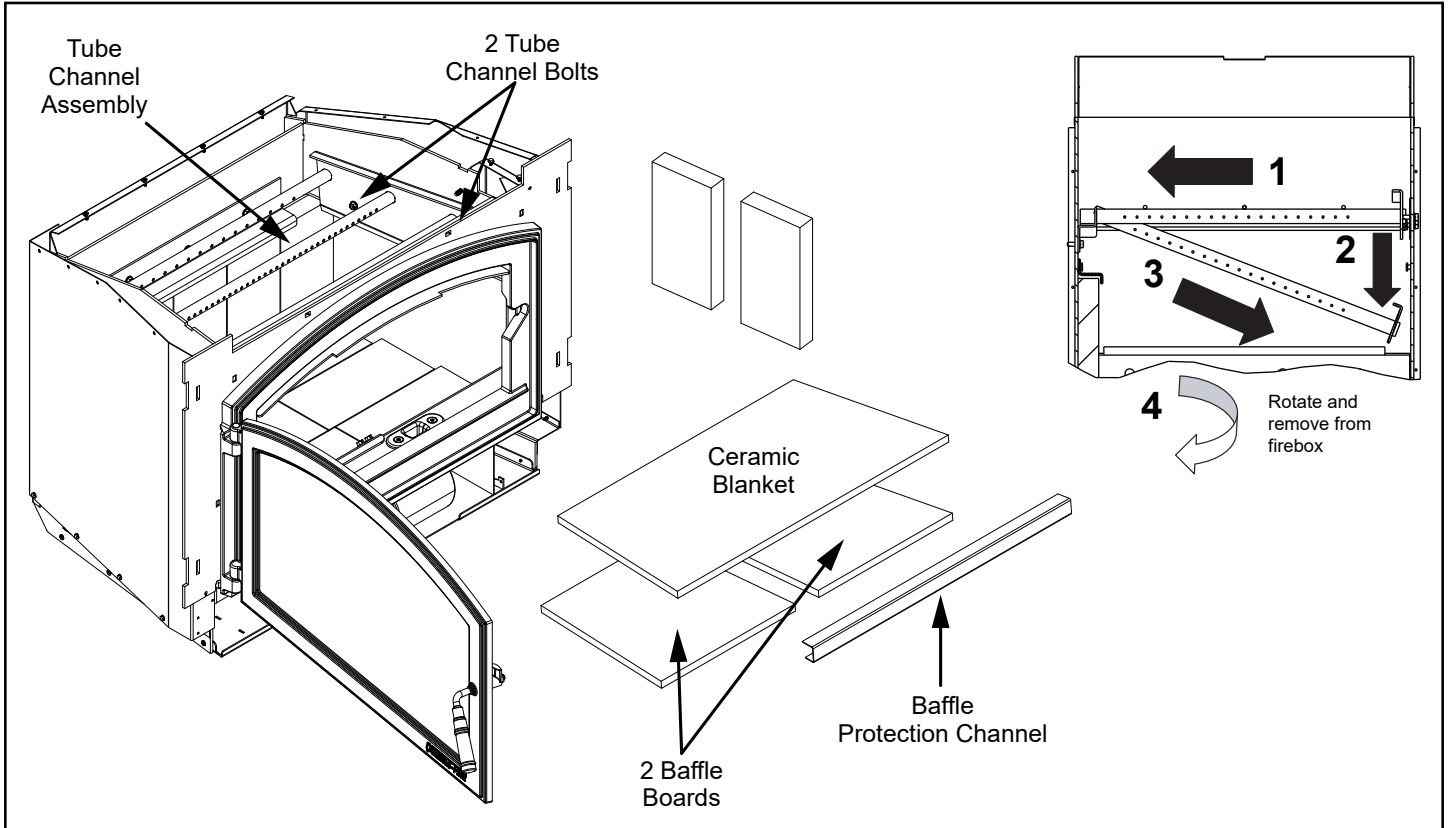

Figure 21.1

4 Troubleshooting Guide

With proper installation, operation, and maintenance your wood appliance will provide years of trouble-free service. If you do experience a problem, this troubleshooting guide will assist you or a qualified service person in the diagnosis of a problem and the corrective action to be taken.

Start Fire Problems	Possible Cause	Solution
Can not get fire started Excessive smoke or spillage Burns too slowly Not enough heat output	Not enough kindling/paper or no kindling/paper	Use dry kindling, more paper. Arrange kindling & wood for air movement.
	Not enough air for fire to ignite	Check for restricted termination cap
		Check for blockage of outside air kit; if installed.
		Check for flue blockage.
		Pre-warm flue before starting fire (refer to section 2J Building a Fire).
		Check for adequate vent height (refer to Chimney Height / Rise and Run section on page 14 of the <u>Installation manual</u>).
	Open window below the appliance towards the wind.	
	Wood condition is too wet, too large	Use dry, seasoned wood (refer to section 2E Seasoned Wood).
	Bed of coals not established before adding wood	Start with paper & kindling to establish bed of coals (refer to section 2J Building a Fire).
Flue blockage such as birds' nests or leaves in termination cap	Have chimney inspected for creosote and cleaned by a certified chimney sweep.	
Down draft or negative pressure Competition with exhaust devices	Do not use exhaust fans during start-up (refer to section 2O Negative Pressure).	
	Open window below the appliance towards the wind.	
Fire burns too fast	Extremely dry or soft wood	Mix in hardwood.
		Mix in less seasoned wood after fire is established (refer to section 2I Wood Fuel).
	Over drafting	Check for correct vent height; too much vertical height creates over drafting.
		Check location of vent termination (refer to Chimney Termination Requirement section on page 13 of the <u>Installation manual</u>).

Table 20.1

B. Service Parts List



Service Parts
Wood Insert

GIFFORD

Beginning Manufacturing Date: May 2022
Ending Manufacturing Date: Active

GIFFORD-CB - Classic Black
GIFFORD-BM - Majolica Brown

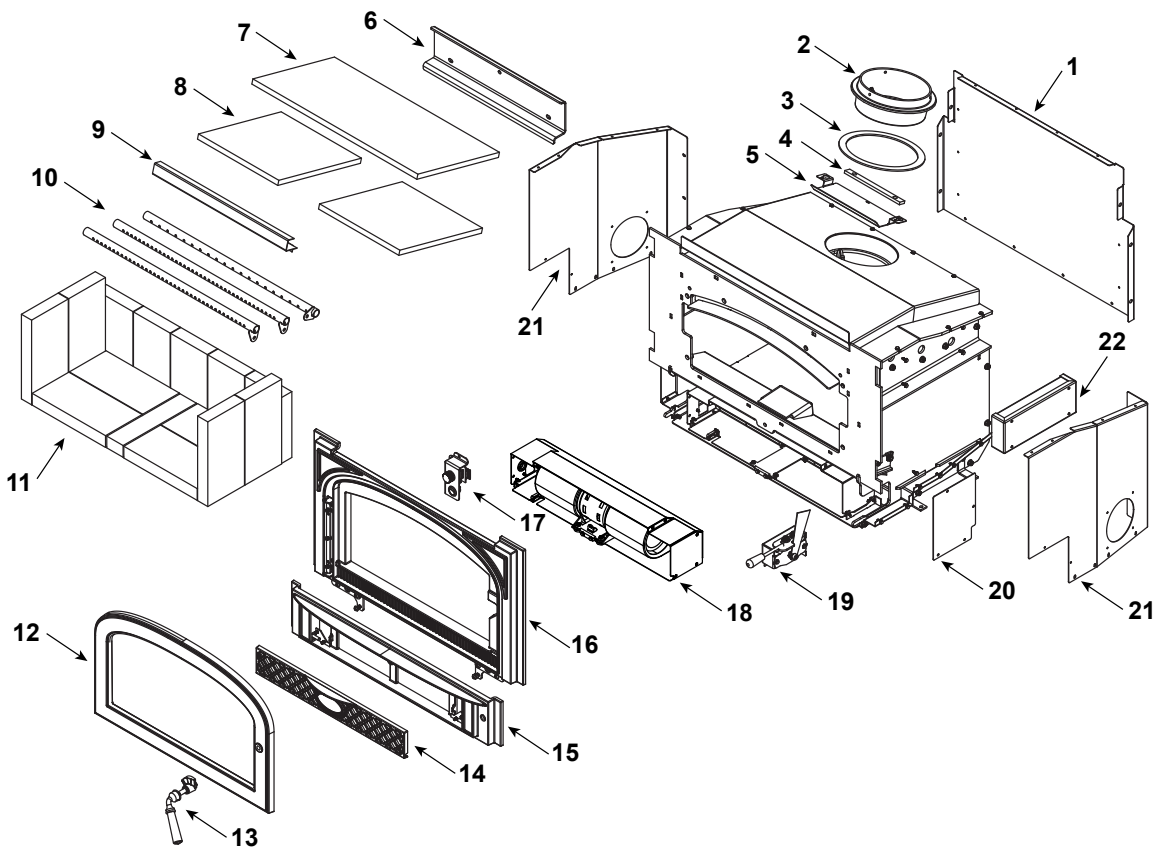

Part number list on following page.

IMPORTANT: THIS IS DATED INFORMATION. Parts must be ordered from a dealer or distributor. **Hearth and Home Technologies does not sell directly to consumers.** Provide model number and serial number when requesting service parts from your dealer or distributor.



Stocked at Depot

ITEM	DESCRIPTION	COMMENTS	PART NUMBER	Stocked at Depot
1	Convection Back		SRV7094-161	
	Hurricane Screw	Pkg of 40	SRV2005-861/40	Y
	Screw, Hwh Ms 1/4-20 X 3/4 Ns	Pkg of 25	220-0080/25	Y
2	Flue Attach Ring		SRV7095-203	
	Bolt 5/16 X 18 X 1		7000-571	Y
	Nut, 5/16-18	Pkg of 10	A-3483-1/10	Y
3	Gasket, Flue Collar		SRV7044-194	
4	Chimney Ring Attach		SRV7044-181	
5	Flue Baffle Plate		SRV7094-185	
6	Rear Brick Retainer		SRV7094-127	
	Screw, Hwh Ms 1/4-20 X 3/4 Ns	Pkg of 25	220-0080/25	
7	Ceramic Fiber Blanket		SRV7094-118	
8	Baffle Board	Pkg of 2	SRV7094-117	Y

#8 Baffle Protection Channel

Side view

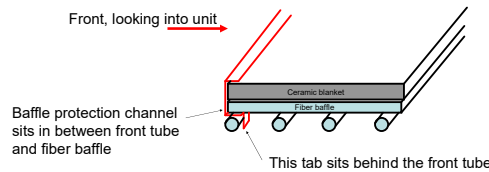

9	Baffle Protection Channel		SRV7094-119	Y
10	Secondary Tubes	Pkg of 3	SRV7094-121	
	Screw, Hwh Ms 1/4-20 X 3/4 Ns	Pkg of 25	220-0080/25	Y
	Nut, Flange 1/4-20	Pkg of 24	226-0130/24	Y

#11 Brick Assembly

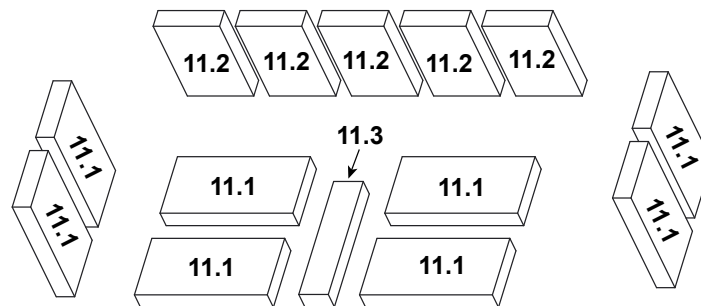

11	Brick Assembly		SRV7094-022	Y
11.1	Brick, Uncut, 9" X 4.5" X 1.25"	Qty 8 req	832-0550	Y
11.2	Brick, 7" X 4.5" X 1.25"	Qty 5 req	SRV7128-011	
11.3	Brick, 9" X 2" X 1.25"	Qty. 1 Req	SRV7128-018	
	Brick, Uncut, 9" X 4.5" X 1.25"	Pkg of 6	832-3040	

Additional service part numbers appear on following page.

IMPORTANT: THIS IS DATED INFORMATION. Parts must be ordered from a dealer or distributor. **Hearth and Home Technologies does not sell directly to consumers.** Provide model number and serial number when requesting service parts from your dealer or distributor.



Stocked at Depot

ITEM	DESCRIPTION	COMMENTS	PART NUMBER	
12	Door Assembly	Classic Black	7102-053CB	
		Majolica Brown	7102-053BM	
12.1	Door	Classic Black	7102-205CB	
		Majolica Brown	7102-205BM	
12.2	Glass Assembly		SRV7094-054	
12.3	Door Hinge Assembly		SRV7102-024	
12.4	Glass Retainers	Pkg of 4	SRV7094-174	
	Screw, Pan Head Phillips, 10-24 x 3/8	Pkg of 10	1200983-10	Y
12.5	Door Gasket, 3/8"	10 Ft	1-00-1203668	Y
13	Door Handle Assembly		SRV7101-022	Y
13.1	Handle		1600664	Y
13.2	Door Handle		SRV7101-021	
13.3	Washer, 3/8 Spring	Pkg of 10	63D0069-10	Y
13.4	Washer, Sae 3/8 (3 ea)	Pkg of 3	832-0990	Y
13.5	Key, cam Latch		SRV430-1151	
13.6	Cam Latch		SRV430-1141	
13.7	Nut, Side Lock Jam	Pkg of 24	226-0100/24	Y
14	Access Door	Classic Black	7102-207CB	
		Majolica Brown	7102-207BM	
15	Front Lower	Classic Black	7102-203CB	
		Majolica Brown	7102-203BM	
16	Front	Classic Black	7102-201CB	
		Majolica Brown	7102-201BM	
	Wire Jacket Rope, 1/2	10 Ft	7000-811/10	

Additional service part numbers appear on following page.

IMPORTANT: THIS IS DATED INFORMATION. Parts must be ordered from a dealer or distributor. **Hearth and Home Technologies does not sell directly to consumers.** Provide model number and serial number when requesting service parts from your dealer or distributor.



Stocked at Depot

ITEM	DESCRIPTION	COMMENTS	PART NUMBER	
<p>#17 Control Panel Assembly</p>				
17	Control Panel Assembly		SRV7101-026	
17.1	Speed Control		SRV7000-888	Y
17.2	Knob, Speed Control		SRV7000-930	Y
17.3	Rocker Switch (Round)		SRV7000-940	Y
<p>#18 Blower Assembly</p>				
18.1	Snap Disc, Box Assembly		SRV7094-068	Y
18.2	Snap Disc		SRV230-0470	Y
18.3	Power Cord	96 inches	3-20-51578	Y
18.4	Wire Harness		SRV7000-891	Y
18.5	Blower Replacement		SRV7000-868	Y
18.6	Blower Housing		SRV7094-032	
19	Timer Control Assembly		SRV7094-025	Y
	Handle		1600663	Y
	Hurricane Screw	Pkg of 40	SRV2005-861/40	Y
	Timer (Only) Replacement Assembly		SRV480-1940	Y
20	OA Cover		SRV7094-234	
21	Combustion Cover	Includes left & right	SRV7094-134	
22	Secondary Box/Covers	Includes left & right	SRV7094-125	
	Hurricane Screw		SRV2005-861/40	Y
	Screw, Hwh Ms 1/4-20 X 3/4 Ns		220-0080/25	Y
	Component Pack	Classic Black	SRV7102-040	
		Majolica Brown	SRV7102-041	

Additional service part numbers appear on following page.

IMPORTANT: THIS IS DATED INFORMATION. Parts must be ordered from a dealer or distributor. **Hearth and Home Technologies does not sell directly to consumers.** Provide model number and serial number when requesting service parts from your dealer or distributor.



Stocked at Depot

ITEM	DESCRIPTION	COMMENTS	PART NUMBER	
#23 Cast Surround				
23	Cast Surround	Classic Black	MED-SM-CB	
		Majolica Brown	MED-SM-BM	
23.1	Surround, Right	Classic Black	7102-217CB	
		Majolica Brown	7102-217BM	
23.2	Surround, Top	Classic Black	7102-215CB	
		Majolica Brown	7102-215BM	
23.3	Surround, Left	Classic Black	7102-219CB	
		Majolica Brown	7102-219BM	
23.4	Surround Retainer		SRV7102-108	
23.5	1/4-20 x 1/2 HFH	Pkg of 10	1200482-10	
	Component Pack, Surround (Contains retainers, washers, & screws)		SRV7101-064	
	Surround Extension		EXPVC-2945	
	Surround 43 x 31		SPG-4331	
	Surround 38 x 28		SPG-3828	
	15 Degree Adapter		DV-6DLR-E15ADSS	

Additional service part numbers appear on following page.

VERMONT CASTINGS™

BY FORGE & FLAME

CONTACT INFORMATION

Hearth & Home Technologies
 352 Mountain House Road
 Halifax, PA 17032

Please contact your Vermont Castings dealer with any questions or concerns.
 For the number of your nearest Vermont Castings dealer
 log onto www.forgenflame.com



CAUTION



DO NOT DISCARD THIS MANUAL

- Important operating and maintenance instructions included.
- Read, understand and follow these instructions for safe installation and operation.
- Leave this manual with party responsible for use and operation of this appliance.



We recommend that you record the following pertinent information for your heating appliance.

Date purchased/installed: _____

Serial Number: _____

Location on appliance: _____

Dealership purchased from: _____

Dealer Phone: 1() - _____

Notes: _____

This product may be covered by one or more of the following patents: (United States) 5341794, 5263471, 6688302, 7216645, 7047962 or other U.S. and foreign patents pending.

